



Features

- RoHS compliant*
- Zener voltages 2.0 V to 39 V
- Fits SOD323 and SOD523



This series is currently available, but not recommended for new designs.

CD0603/1005-Z Surface Mount Zener Diode Series

General Information

The markets of portable communications, computing and video equipment are challenging the semiconductor industry to develop increasingly smaller electronic components.

Bourns offers Zener Diodes for voltage reference applications, in compact chip package 0603 and 1005 size format, which offer PCB real estate savings and are considerably smaller than most competitive parts. The Zener Diodes have a zener voltage range between 2.0 V and 39 V.

Bourns® Chip Diodes conform to JEDEC standards, are easy to handle on standard pick and place equipment and their flat configuration minimizes roll away.

Electrical and Thermal Characteristics (@ T_A = 25 °C Unless Otherwise Noted)

| Parameter | Symbol | CD1005-Z | CD0603-Z | Unit |
|---|------------------|-------------|-------------|------|
| Power Dissipation @ T=25 °C | P _D | 200 | 150 | mW |
| Peak Forward Surge Current 8.3 ms Single Half Sine-wave Superimposed on Rated Load (JEDEC Method) | I _{FSM} | 2.0 | 2.0 | A |
| Operating and Storage Temperature Range | T _J | -55 to +125 | -55 to +125 | °C |

Notes:

1. Pulse test width PW=300 μsec, 1 % duty cycle.
2. Mounted on P.C. board with 0.2 x 0.2 " (5.0 x 5.0 mm) copper pad areas.

How To Order

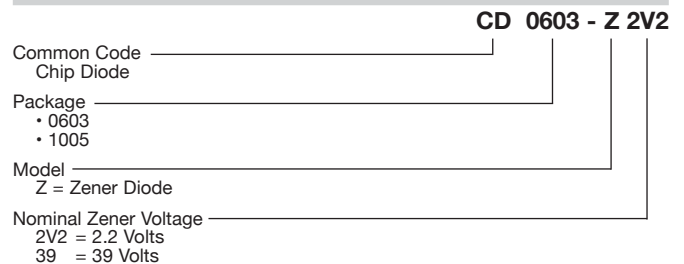

BOURNS®

Asia-Pacific:

Tel: +886-2 2562-4117 • Fax: +886-2 2562-4116

EMEA:

Tel: +36 88 520 390 • Fax: +36 88 520 211

The Americas:

Tel: +1-951 781-5500 • Fax: +1-951 781-5700

www.bourns.com

*RoHS Directive 2002/95/EC Jan. 27, 2003 including annex and RoHS Recast 2011/65/EU June 8, 2011.

Specifications are subject to change without notice.

The device characteristics and parameters in this data sheet can and do vary in different applications and actual device performance may vary over time. Users should verify actual device performance in their specific applications.

Applications

- DC-DC converters
- Portable electronics
- Industrial controllers
- Desktop PCs and notebooks

CD0603/1005-Z Surface Mount Zener Diode Series **BOURNS®**

Electrical Characteristics (@ T_A = 25 °C Unless Otherwise Noted)

| Part Number | | Part Marking | Zener Voltage | | | Zener Impedance | | | | Reverse Current | |
|-------------|--------|--------------|---------------|--------|---------------------|-----------------|----------------|-----------------|----------------|-----------------|-----|
| | | | VZ | | | Z _{ZT} | I _Z | Z _{ZK} | I _Z | I _R | |
| CD0603 | CD1005 | | Min. V | Max. V | I _Z (mA) | Ohms | mA | Ohms | mA | μA | VR |
| -Z2 | -Z2 | Z0 | 1.90 | 2.1 | 5 | 100 | 5 | 600 | 1 | 100 | 1 |
| -Z2V2 | -Z2V2 | Z1 | 2.09 | 2.31 | 5 | 100 | 5 | 600 | 1 | 100 | 1 |
| -Z2V4 | -Z2V4 | Z2 | 2.28 | 2.52 | 5 | 85 | 5 | 600 | 1 | 100 | 1 |
| -Z2V7 | -Z2V7 | Z3 | 2.57 | 2.84 | 5 | 83 | 5 | 500 | 1 | 75 | 1 |
| -Z3 | -Z3 | Z4 | 2.85 | 3.15 | 5 | 95 | 5 | 500 | 1 | 50 | 1 |
| -Z3V3 | -Z3V3 | Z5 | 3.14 | 3.47 | 5 | 95 | 5 | 500 | 1 | 25 | 1 |
| -Z3V6 | -Z3V6 | Z6 | 3.42 | 3.78 | 5 | 95 | 5 | 500 | 1 | 15 | 1 |
| -Z3V9 | -Z3V9 | Z7 | 3.71 | 4.10 | 5 | 95 | 5 | 500 | 1 | 10 | 1 |
| -Z4V3 | -Z4V3 | Z8 | 4.09 | 4.52 | 5 | 95 | 5 | 500 | 1 | 5 | 1 |
| -Z4V7 | -Z4V7 | Z9 | 4.47 | 4.94 | 5 | 78 | 5 | 500 | 1 | 5 | 2 |
| -Z5V1 | -Z5V1 | ZA | 4.85 | 5.36 | 5 | 60 | 5 | 480 | 1 | 0.1 | 0.8 |
| -Z5V6 | -Z5V6 | ZB | 5.32 | 5.88 | 5 | 40 | 5 | 400 | 1 | 0.1 | 1 |
| -Z6V2 | -Z6V2 | ZC | 5.89 | 6.51 | 5 | 10 | 5 | 200 | 1 | 0.1 | 2 |
| -Z6V8 | -Z6V8 | ZE | 6.46 | 7.14 | 5 | 8 | 5 | 150 | 1 | 0.1 | 3 |
| -Z7V5 | -Z7V5 | ZF | 7.13 | 7.88 | 5 | 7 | 5 | 50 | 1 | 0.1 | 5 |
| -Z8V2 | -Z8V2 | ZG | 7.79 | 8.61 | 5 | 7 | 5 | 50 | 1 | 0.1 | 6 |
| -Z9V1 | -Z9V1 | ZH | 8.65 | 9.56 | 5 | 10 | 5 | 50 | 1 | 0.1 | 7 |
| -Z10 | -Z10 | ZJ | 9.50 | 10.50 | 5 | 15 | 5 | 70 | 1 | 0.1 | 7.5 |
| -Z11 | -Z11 | ZK | 10.45 | 11.55 | 5 | 20 | 5 | 70 | 1 | 0.1 | 8.5 |
| -Z12 | -Z12 | ZM | 11.40 | 12.60 | 5 | 20 | 5 | 90 | 1 | 0.1 | 9 |
| -Z13 | -Z13 | ZN | 12.35 | 13.65 | 5 | 25 | 5 | 110 | 1 | 0.1 | 10 |
| -Z15 | -Z15 | ZP | 14.25 | 15.75 | 5 | 30 | 5 | 110 | 1 | 0.1 | 11 |
| -Z16 | -Z16 | ZQ | 15.20 | 16.80 | 5 | 40 | 5 | 170 | 1 | 0.1 | 12 |
| -Z18 | -Z18 | ZR | 17.10 | 18.90 | 5 | 50 | 5 | 170 | 1 | 0.1 | 14 |
| -Z20 | -Z20 | ZS | 19.00 | 21.00 | 5 | 50 | 5 | 220 | 1 | 0.1 | 15 |
| -Z22 | -Z22 | ZT | 20.90 | 23.10 | 5 | 55 | 5 | 220 | 1 | 0.1 | 17 |
| -Z24 | -Z24 | ZU | 22.80 | 25.20 | 5 | 80 | 5 | 220 | 1 | 0.1 | 18 |
| -Z27 | -Z27 | ZV | 25.65 | 28.35 | 5 | 80 | 5 | 250 | 1 | 0.1 | 20 |
| -Z30 | -Z30 | ZW | 28.50 | 31.50 | 5 | 80 | 5 | 250 | 1 | 0.1 | 23 |
| -Z33 | -Z33 | ZX | 31.35 | 34.65 | 5 | 80 | 5 | 250 | 1 | 0.1 | 25 |
| -Z36 | -Z36 | ZY | 34.20 | 37.80 | 5 | 90 | 5 | 250 | 1 | 0.1 | 27 |
| -Z39 | -Z39 | ZZ | 37.05 | 40.95 | 5 | 90 | 5 | 300 | 1 | 0.1 | 39 |

Specifications are subject to change without notice.

The device characteristics and parameters in this data sheet can and do vary in different applications and actual device performance may vary over time. Users should verify actual device performance in their specific applications.

CD0603/1005-Z Surface Mount Zener Diode Series



Product Dimensions

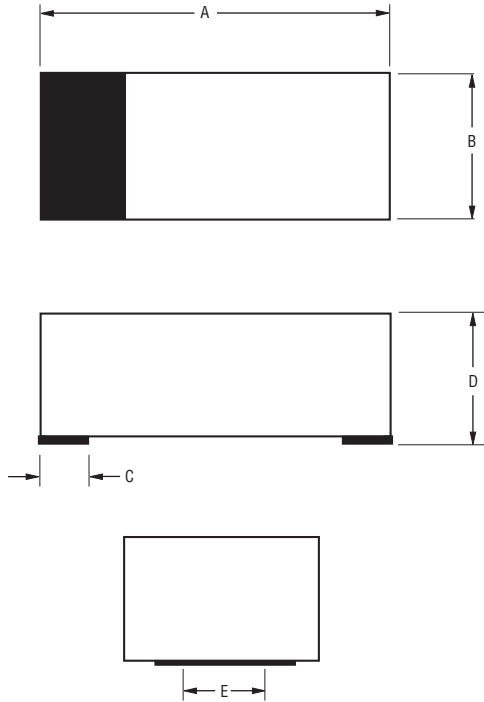

| Dimension | 0603 | 1005 |
|-----------|---------------------------------------|---------------------------------------|
| A | $\frac{1.60 - 1.80}{(0.063 - 0.071)}$ | $\frac{2.40 - 2.60}{(0.095 - 0.102)}$ |
| B | $\frac{0.80 - 1.00}{(0.031 - 0.039)}$ | $\frac{1.10 - 1.30}{(0.043 - 0.051)}$ |
| C | $\frac{0.45}{(0.018)}$ Typ. | $\frac{0.50}{(0.020)}$ Typ. |
| D | $\frac{0.70 - 0.85}{(0.027 - 0.033)}$ | $\frac{0.70 - 0.90}{(0.027 - 0.035)}$ |
| E | $\frac{0.70}{(0.028)}$ Typ. | $\frac{1.00}{(0.039)}$ Typ. |

DIMENSIONS: $\frac{\text{MM}}{\text{(INCHES)}}$

Recommended Pad Layout

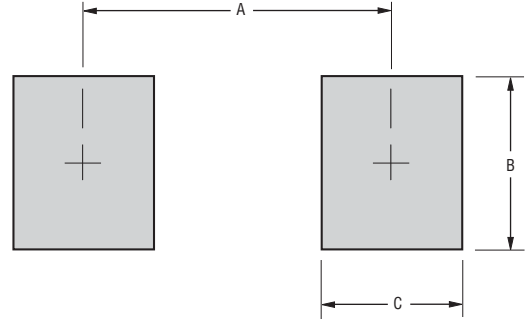

| Dimension | 0603 | 1005 |
|-----------|------------------------|------------------------|
| A (Max.) | $\frac{1.25}{(0.049)}$ | $\frac{2.00}{(0.079)}$ |
| B (Min.) | $\frac{1.00}{(0.039)}$ | $\frac{1.3}{(0.051)}$ |
| C (Min.) | $\frac{0.6}{(0.024)}$ | $\frac{0.7}{(0.028)}$ |

DIMENSIONS: $\frac{\text{MM}}{\text{(INCHES)}}$

Physical Specifications

Case0603(1608) / 1005(2512) Molded plastic
 TerminalsGold plated, solderable per MIL-STD-750,
 Method 2026
 PolarityIndicated by cathode band
 Mounting PositionAny

Specifications are subject to change without notice.
 The device characteristics and parameters in this data sheet can and do vary in different applications and actual device performance may vary over time.
 Users should verify actual device performance in their specific applications.

CD0603/1005-Z Surface Mount Zener Diode Series



Rating and Characteristic Curves

Temperature Sensitivity

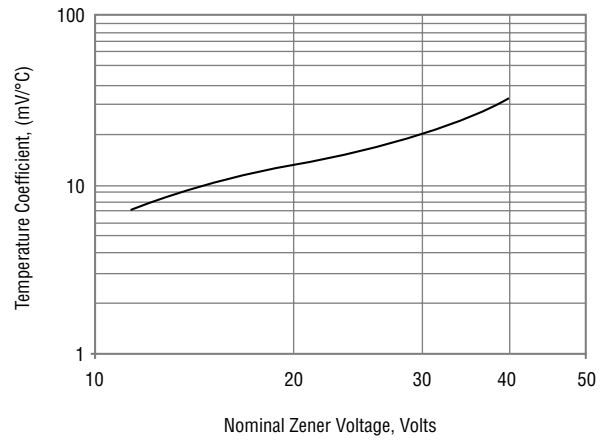
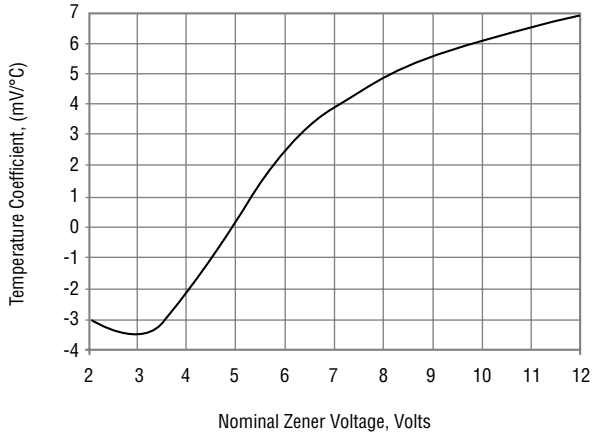

Zener Current vs. Zener Voltage Characteristics

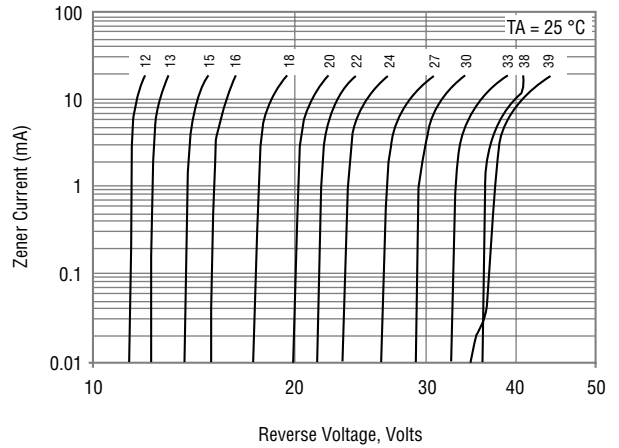
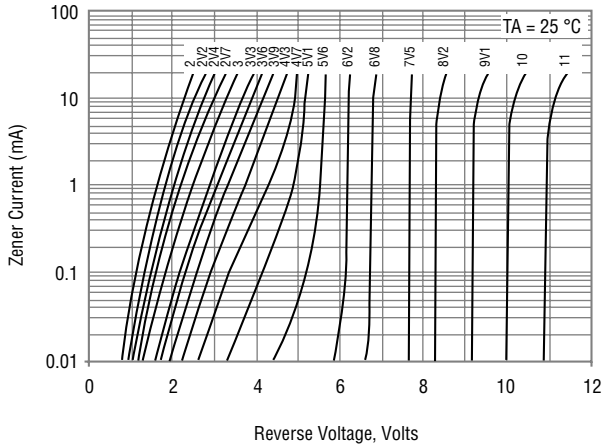

Derating Curve

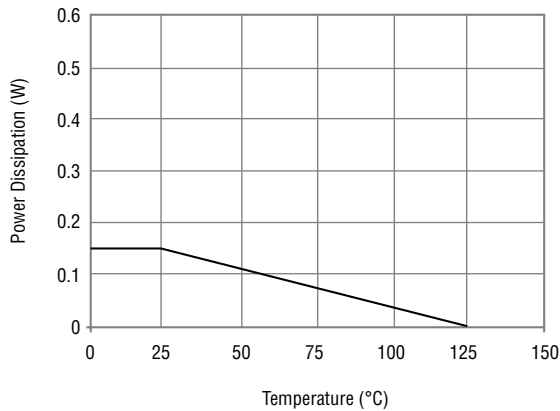

Typical Junction Capacitance

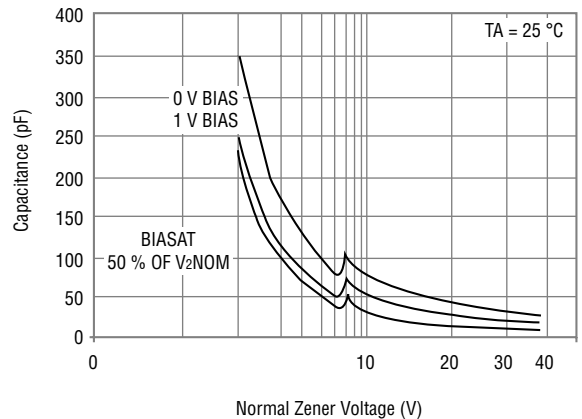

Specifications are subject to change without notice.
The device characteristics and parameters in this data sheet can and do vary in different applications and actual device performance may vary over time.
Users should verify actual device performance in their specific applications.

CD0603/1005-Z Surface Mount Zener Diode Series

BOURNS®

Rating and Characteristic Curves:

Zener Impedance vs. Voltage

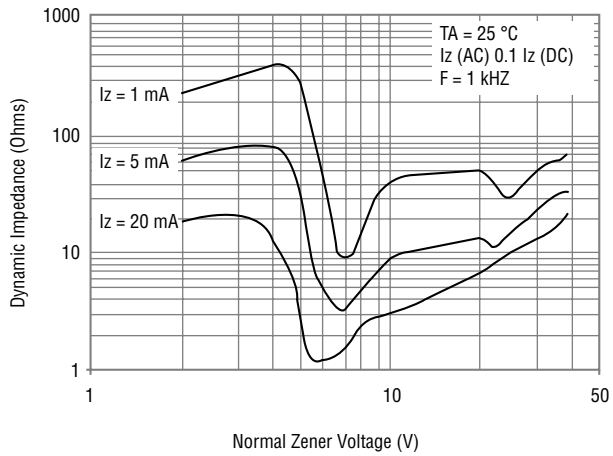

Forward Current vs. Voltage

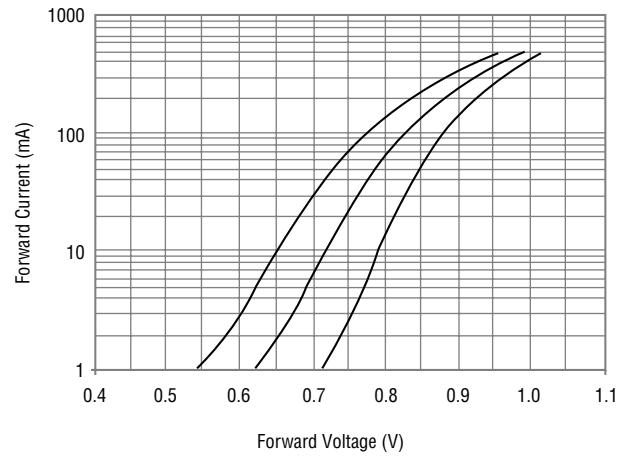

Specifications are subject to change without notice.

The device characteristics and parameters in this data sheet can and do vary in different applications and actual device performance may vary over time. Users should verify actual device performance in their specific applications.

CD0603/1005-Z Surface Mount Zener Diode Series

BOURNS®

Packaging Information

The product will be dispensed in Tape and Reel format (see diagram below).

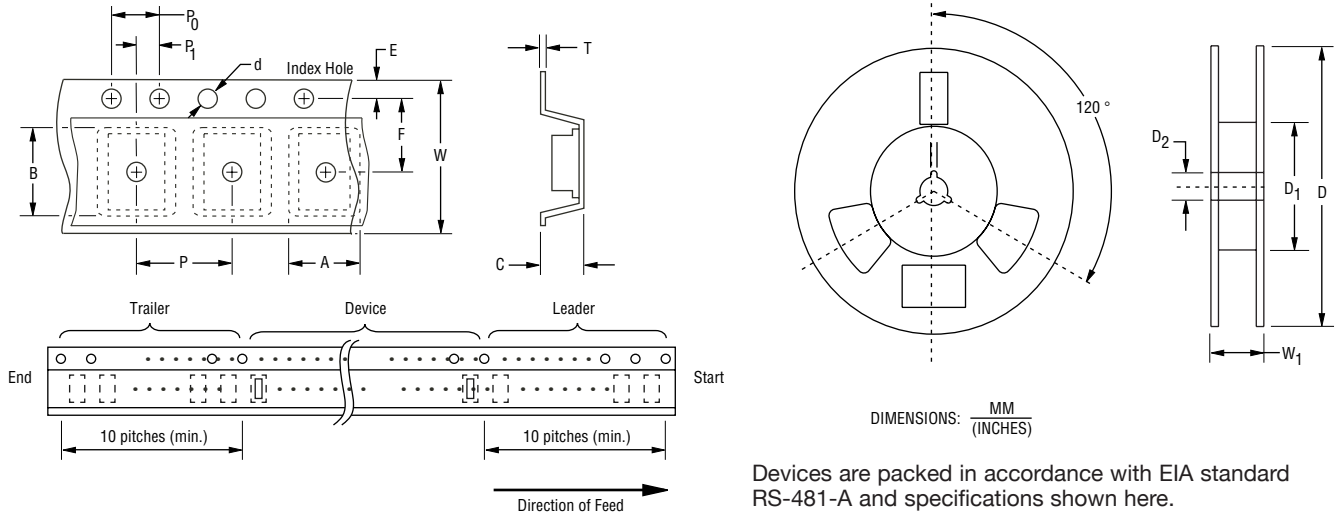

Devices are packed in accordance with EIA standard RS-481-A and specifications shown here.

| Item | Symbol | 0603 | 1005 |
|------------------------|----------------|---|---|
| Carrier Width | A | $\frac{1.00 \pm 0.10}{(0.039 - 0.004)}$ | $\frac{1.55 \pm 0.10}{(0.061 - 0.004)}$ |
| Carrier Length | B | $\frac{1.85 \pm 0.10}{(0.073 - 0.004)}$ | $\frac{2.65 \pm 0.10}{(0.104 - 0.004)}$ |
| Carrier Depth | C | $\frac{1.00 \pm 0.10}{(0.039 - 0.004)}$ | $\frac{1.05 \pm 0.10}{(0.041 - 0.004)}$ |
| Sprocket Hole | d | $\frac{1.55 \pm 0.05}{(0.061 - 0.002)}$ | $\frac{1.55 \pm 0.10}{(0.061 - 0.004)}$ |
| Reel Outside Diameter | D | $\frac{178}{(7.008)}$ | $\frac{178}{(7.008)}$ |
| Reel Inner Diameter | D ₁ | $\frac{60.0}{(2.362)}$ MIN. | $\frac{60.0}{(2.362)}$ MIN. |
| Feed Hole Diameter | D ₂ | $\frac{13.0 \pm 0.20}{(0.512 - 0.008)}$ | $\frac{13.0 \pm 0.20}{(0.512 - 0.008)}$ |
| Sprocket Hole Position | E | $\frac{1.75 \pm 0.10}{(0.069 - 0.004)}$ | $\frac{1.75 \pm 0.10}{(0.069 - 0.004)}$ |
| Punch Hole Position | F | $\frac{3.50 \pm 0.05}{(0.138 - 0.002)}$ | $\frac{3.50 \pm 0.05}{(0.138 - 0.002)}$ |
| Punch Hole Pitch | P | $\frac{4.00 \pm 0.10}{(0.157 - 0.004)}$ | $\frac{4.00 \pm 0.10}{(0.157 - 0.004)}$ |
| Sprocket Hole Pitch | P ₀ | $\frac{4.00 \pm 0.10}{(0.157 - 0.004)}$ | $\frac{4.00 \pm 0.10}{(0.157 - 0.004)}$ |
| Embossment Center | P ₁ | $\frac{2.00 \pm 0.05}{(0.079 - 0.002)}$ | $\frac{2.00 \pm 0.05}{(0.079 - 0.002)}$ |
| Overall Tape Thickness | T | $\frac{0.20 \pm 0.05}{(0.008 - 0.002)}$ | $\frac{0.25 \pm 0.05}{(0.010 - 0.002)}$ |
| Tape Width | W | $\frac{8.00 \pm 0.20}{(0.315 - 0.008)}$ | $\frac{8.00 \pm 0.20}{(0.315 - 0.008)}$ |
| Reel Width | W ₁ | $\frac{13.5}{(0.531)}$ MAX. | $\frac{13.5}{(0.531)}$ MAX. |
| Quantity per Reel | -- | 4,000 | 4,000 |

REV. 10/15

Specifications are subject to change without notice.

The device characteristics and parameters in this data sheet can and do vary in different applications and actual device performance may vary over time.

Users should verify actual device performance in their specific applications.