

Features

- Superior circuit protection
- Overcurrent and overvoltage protection
- Blocks surges up to rated limits
- High-speed performance
- Small SMT package
- RoHS compliant*
- Agency recognition: 



The Model TBU-KE Series is obsolete and not recommended for new designs. [The Model TBU-DT Series](#) is the recommended alternative but is not pin-to-pin compatible.

TBU-KE Series - TBU® High-Speed Protectors

General Information

The TBU-KE Series of Bourns® TBU® (Transient Blocking Unit) products are very low capacitance unidirectional high-speed surge protection components designed to protect against faults caused by short circuits, AC power cross, induction and lightning surges.

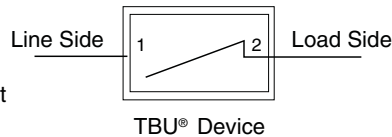

Agency Approval

Description	
UL	File Number: E315805

The TBU-KE is a unidirectional TBU® device: the TBU® protector will trip in less than 1 μ s when the current reaches the maximum value in one direction only, that is when Pin 1 is positive in voltage with respect to Pin 2. No current limiting exists in the opposite polarity, and the TBU® protector appears as resistive in nature. The reverse current should not exceed the maximum trigger current level of the TBU® device. An external diode may be used to prevent reverse current in DC biased applications.

The TBU® protector blocks surges and provides an effective barrier behind which sensitive electronics will not be exposed to large voltages or currents during surge events. After the surge, the TBU® device resets when the voltage across the TBU® device falls to the V_{reset} level. The TBU® device will automatically reset on lines which have no DC bias or have DC bias below V_{reset} (such as unpowered signal lines).

The TBU® device is provided in a surface mount DFN package and meets industry standard requirements such as RoHS and Pb Free solder reflow profiles.

Absolute Maximum Ratings (@ $T_A = 25^\circ\text{C}$ Unless Otherwise Noted)

Symbol	Parameter	Part Number	Value	Unit
V_{imp}	Peak impulse voltage withstand with duration less than 10 ms	TBU-KE025-xxx-WH	250	V
		TBU-KE040-xxx-WH	400	
		TBU-KE050-xxx-WH	500	
V_{rms}	Continuous A.C. RMS voltage	TBU-KE025-xxx-WH	100	V
		TBU-KE040-xxx-WH	200	
		TBU-KE050-xxx-WH	250	
T_{op}	Operating temperature range		-40 to +125	$^\circ\text{C}$
T_{stg}	Storage temperature range		-65 to +150	$^\circ\text{C}$

BOURNS®

Asia-Pacific: Tel: +886-2 2562-4117 • Fax: +886-2 2562-4116

EMEA: Tel: +36 88 520 390 • Fax: +36 88 520 211

The Americas: Tel: +1-951 781-5500 • Fax: +1-951 781-5700

www.bourns.com

*RoHS Directive 2002/95/EC Jan. 27, 2003 including annex and RoHS Recast 2011/65/EU June 8, 2011.

Specifications are subject to change without notice.

The device characteristics and parameters in this data sheet can and do vary in different applications and actual device performance may vary over time. Users should verify actual device performance in their specific applications.

Applications

- Set top box LNB ports
- Protection modules and dongles
- Process control equipment
- Test and measurement equipment
- General electronics

TBU-KE Series - TBU® High-Speed Protectors

BOURNS®

Electrical Characteristics (@ T_A = 25 °C Unless Otherwise Noted)

Symbol	Parameter	Part Number	Min.	Typ.	Max.	Unit	
I _{trigger}	Current required for the device to go from operating state to protected state	TBU-KExxx-050-WH	50	75	100	mA	
		TBU-KExxx-100-WH	100	150	200		
		TBU-KExxx-200-WH	200	300	400		
		TBU-KExxx-300-WH	300	450	600		
		TBU-KExxx-500-WH	500	750	1000		
R _{device}	Series resistance of the TBU® device	V _{imp} = 250 V I _{trigger} (min.) = 50 mA	TBU-KE025-050-WH		12.5	14.6	Ω
		V _{imp} = 250 V I _{trigger} (min.) = 100 mA	TBU-KE025-100-WH		6.3	7.5	
		V _{imp} = 250 V I _{trigger} (min.) = 200 mA	TBU-KE025-200-WH		3.4	4.1	
		V _{imp} = 250 V I _{trigger} (min.) = 300 mA	TBU-KE025-300-WH		2.4	3.1	
		V _{imp} = 250 V I _{trigger} (min.) = 500 mA	TBU-KE025-500-WH		1.8	2.3	
		V _{imp} = 400 V I _{trigger} (min.) = 50 mA	TBU-KE040-050-WH		13.0	15.2	
		V _{imp} = 400 V I _{trigger} (min.) = 100 mA	TBU-KE040-100-WH		6.8	8.1	
		V _{imp} = 400 V I _{trigger} (min.) = 200 mA	TBU-KE040-200-WH		3.9	4.7	
		V _{imp} = 400 V I _{trigger} (min.) = 300 mA	TBU-KE040-300-WH		3.0	3.7	
		V _{imp} = 400 V I _{trigger} (min.) = 500 mA	TBU-KE040-500-WH		2.3	2.9	
		V _{imp} = 500 V I _{trigger} (min.) = 50 mA	TBU-KE050-050-WH		13.7	16.0	
		V _{imp} = 500 V I _{trigger} (min.) = 100 mA	TBU-KE050-100-WH		7.5	8.9	
		V _{imp} = 500 V I _{trigger} (min.) = 200 mA	TBU-KE050-200-WH		4.6	5.5	
		V _{imp} = 500 V I _{trigger} (min.) = 300 mA	TBU-KE050-300-WH		3.6	4.5	
		V _{imp} = 500 V I _{trigger} (min.) = 500 mA	TBU-KE050-500-WH		3.0	3.6	
t _{block}	Time for the device to go from normal operating state to protected state				1	μs	
I _Q	Current through the triggered TBU® device with 50 Vdc circuit voltage		0.25	0.50	1.00	mA	
V _{reset}	Voltage below which the triggered TBU® device will transition to normal operating state		10	14	18	V	
R _{th(j-l)}	Junction to package pads - FR4 using recommended pad layout			116		°C/W	
R _{th(j-l)}	Junction to package pads - FR4 using heat sink on board (6 cm ²)			96		°C/W	

Specifications are subject to change without notice.

The device characteristics and parameters in this data sheet can and do vary in different applications and actual device performance may vary over time. Users should verify actual device performance in their specific applications.

TBU-KE Series - TBU® High-Speed Protectors

BOURNS®

Reference Application

The TBU® device can be used to protect against excessive voltage surges in DC biased equipment, as shown in the figure below. Diode D1 prevents reverse voltage surges from damaging the equipment, and the TBU® protector prevents any positive surges from causing damage. An overvoltage protection device, such as an MOV, may be used to provide additional overvoltage protection if the surge voltage is likely to be above the maximum rating of the TBU® device. D1 reverse voltage rating should be greater than that of the OVP device at the maximum surge current level. Typically, a 1N4007 is a suitable choice. D2 should be chosen to be above the normal working voltage of the protected device, but below its absolute maximum rating.

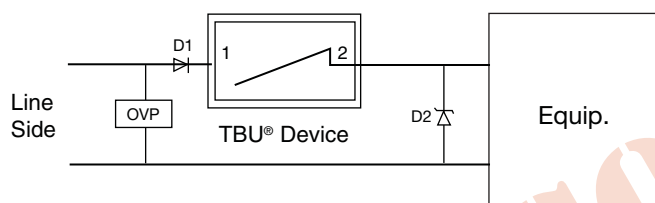

Basic TBU Operation

The TBU® device is a silicon-based, solid-state, resettable device which is placed in series with a signal path. The TBU® device operates in approximately 1 μ s - once line current exceeds the TBU® device's trigger current I_{trigger} . When operated, the TBU® device restricts line current to less than 1 mA typically. When operated, the TBU® device will block all system voltages and any other voltages including the surge up to rated limits.

After the surge, the TBU® device resets when the voltage across the TBU® device falls to the V_{reset} level. The TBU® device will automatically reset on lines which have no DC bias or have DC bias below V_{reset} (such as unpowered signal lines).

If the line has a normal DC bias above V_{reset} , the voltage across the TBU® device may not fall below V_{reset} after the surge. In such cases, special care needs to be taken to ensure that the TBU® device will reset, otherwise an automatic or manual power down will be required. Bourns application engineers can provide further assistance.

Performance Graphs

V-I Characteristic - TBU-KE050-300-WH (Pin 2-1)

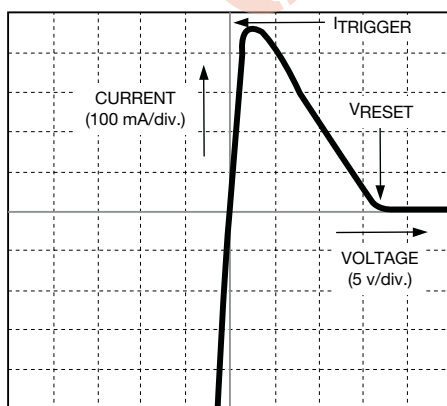

Typical Trigger Current vs. Temperature

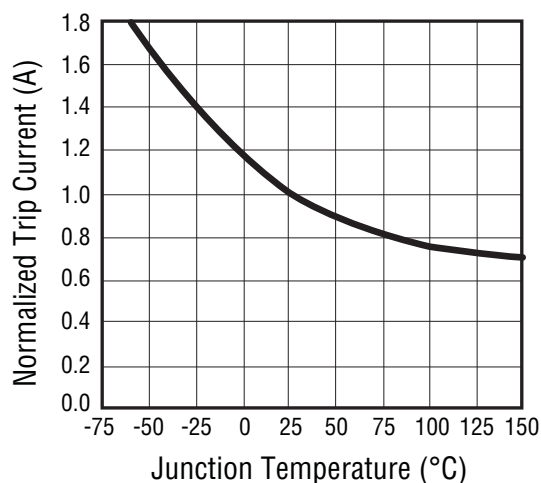

Performance Graphs (Continued)

Power Derating Curve

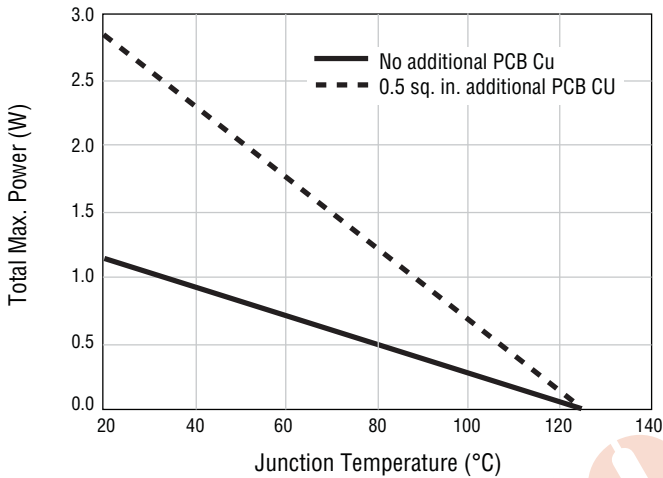

Typical Resistance vs. Temperature

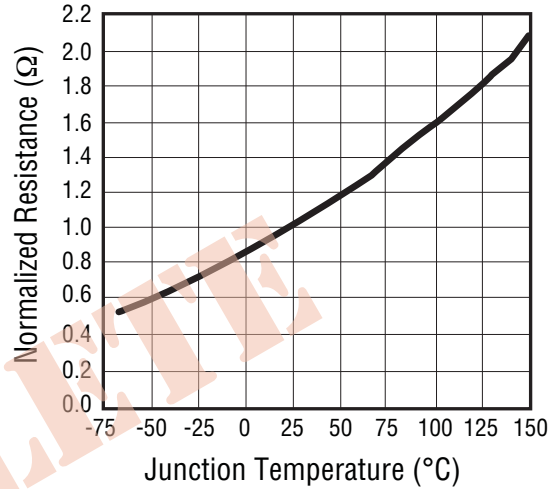

Reflow Profile

Profile Feature	Pb-Free Assembly
Average Ramp-Up Rate (T _{smax} to T _p)	3 °C/sec. max.
Preheat	
- Temperature Min. (T _{smin})	150 °C
- Temperature Max. (T _{smax})	200 °C
- Time (t _{smin} to t _{smax})	60-180 sec.
Time maintained above:	
- Temperature (T _L)	217 °C
- Time (t _L)	60-150 sec.
Peak/Classification Temperature (T _p)	260 °C
Time within 5 °C of Actual Peak Temp. (t _p)	20-40 sec.
Ramp-Down Rate	6 °C/sec. max.
Time 25 °C to Peak Temperature	8 min. max.

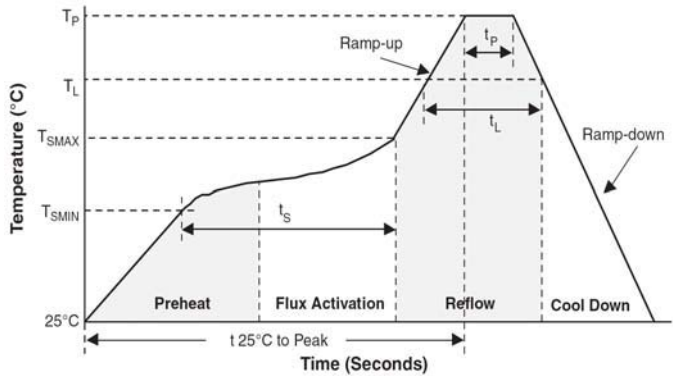

TBU-KE Series - TBU® High-Speed Protectors

BOURNS®

Product Dimensions

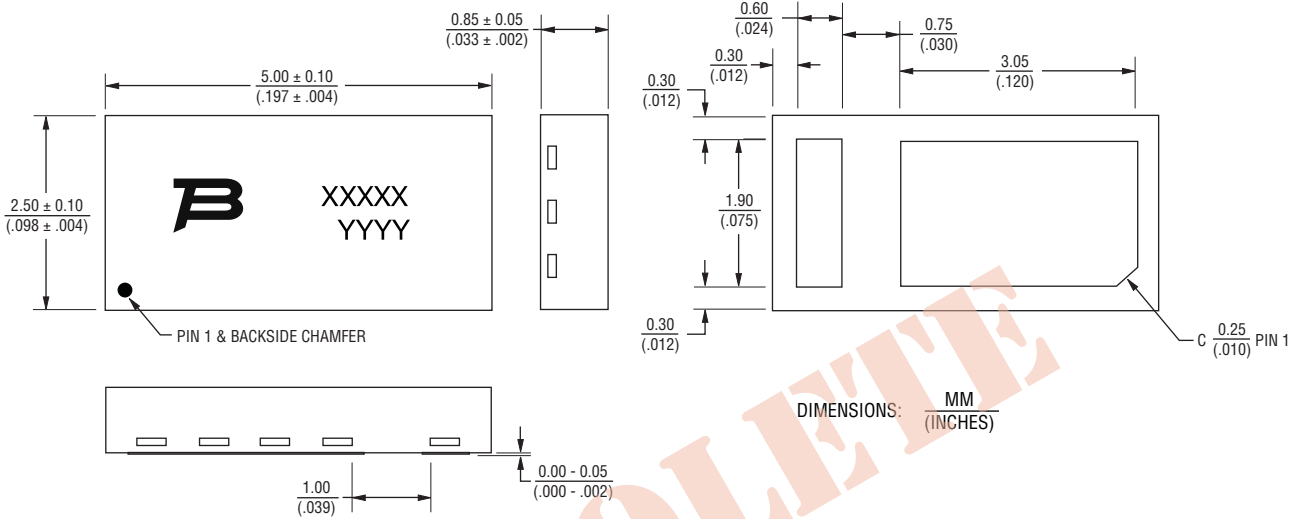

Recommended Pad Layout

TBU® High-Speed Protectors have a 100 % matte-tin termination finish. For improved thermal dissipation, the recommended layout uses PCB copper areas which extend beyond the exposed solder pad. The exposed solder pads should be defined by a solder mask which matches the pad layout of the TBU® device in size and spacing. It is recommended that they should be the same dimension as the TBU® pads but if smaller solder pads are used, they should be centered on the TBU® package terminal pads and not more than 0.10-0.12 mm (0.004-0.005 in.) smaller in overall width or length. Solder pad areas should not be larger than the TBU® pad sizes to ensure adequate clearance is maintained. The recommended

stencil thickness is 0.10-0.12 mm (0.004-0.005 in.) with a stencil opening size 0.025 mm (0.0010 in.) less than the solder pad size. Extended copper areas beyond the solder pad significantly improve the junction to ambient thermal resistance, resulting in operation at lower junction temperatures with a corresponding benefit of reliability. All pads should be soldered to the PCB, including pads marked as NC or NU but no electrical connection should be made to these pads. For minimum parasitic capacitance, it is recommended that signal, ground or power signals are not routed beneath any pad.

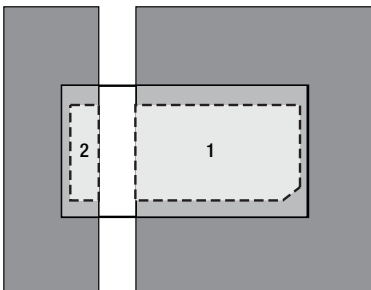

Pad Designation

Pad #	Pin Out
1	Line Side
2	Load Side

Dark grey areas show added PCB copper area for better thermal resistance.

Thermal Resistance vs. Additional PCB Cu Area

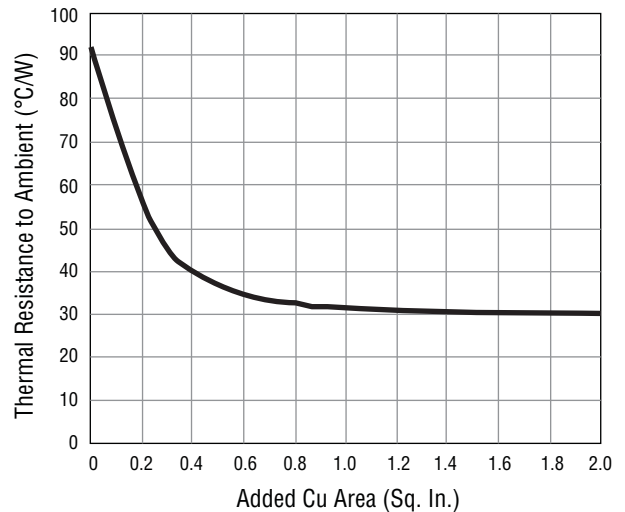

Specifications are subject to change without notice. The device characteristics and parameters in this data sheet can and do vary in different applications and actual device performance may vary over time. Users should verify actual device performance in their specific applications.

TBU-KE Series - TBU® High-Speed Protectors

BOURNS®

How to Order

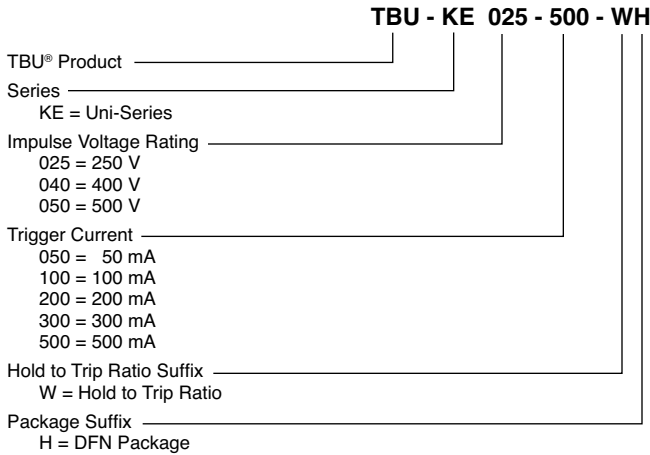

Typical Part Marking

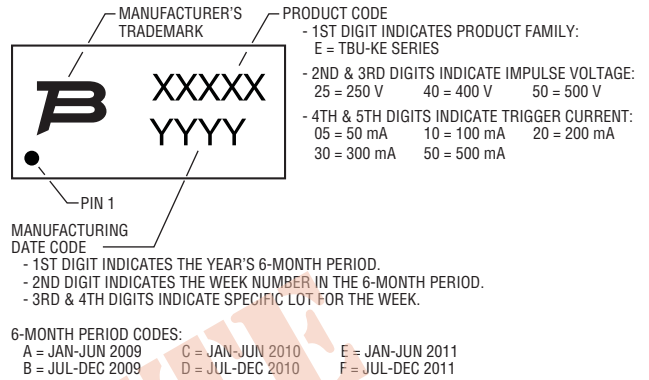

Packaging Specifications

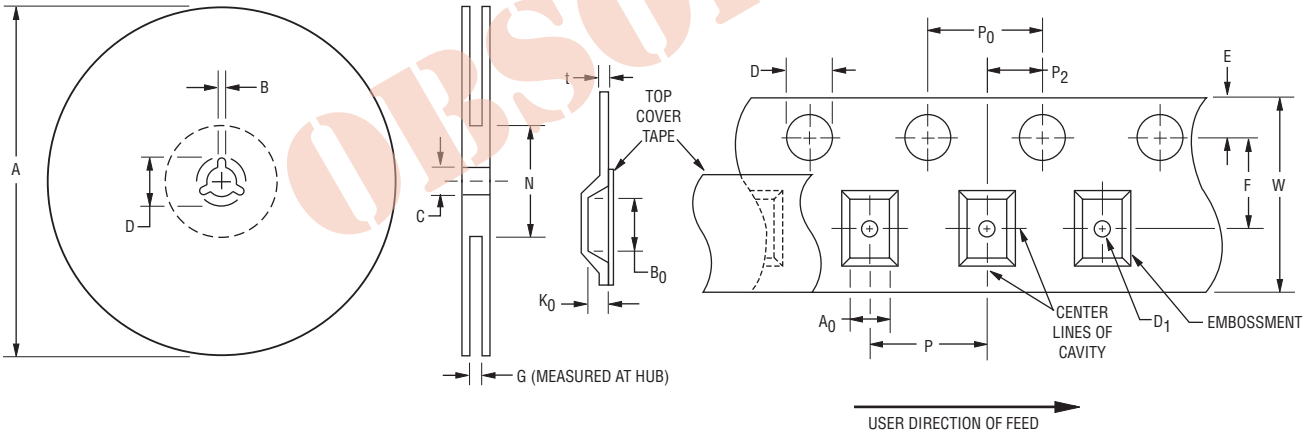

A		B		C		D		G	N
Min.	Max.	Min.	Max.	Min.	Max.	Min.	Max.	Ref.	Ref.
176	178	1.5	2.5	12.8	13.5	20.2	-	16.5	102
(6.929)	(7.008)	(.059)	(.098)	(.504)	(.531)	(.795)		(.650)	(4.016)

A0		B0		D		D1		E		F	
Min.	Max.	Min.	Max.	Min.	Max.	Min.	Max.	Min.	Max.	Min.	Max.
2.8	3.0	5.4	5.6	1.5	1.6	1.5	-	1.65	1.85	5.45	5.55
(.110)	(.118)	(.212)	(.220)	(.059)	(.063)	(.059)		(.065)	(.073)	(.214)	(.218)
K0		P		P0		P2		t		W	
Min.	Max.	Min.	Max.	Min.	Max.	Min.	Max.	Min.	Max.	Min.	Max.
1.1	1.3	3.8	4.2	3.8	4.2	1.95	2.05	0.25	0.35	11.7	12.3
(.043)	(.051)	(.150)	(.165)	(.150)	(.165)	(.077)	(.081)	(.010)	(.014)	(.461)	(.484)

DIMENSIONS: $\frac{\text{MM}}{\text{(INCHES)}}$

REV. 04/15

"TBU" is a registered trademark of Bourns, Inc. in the United States and other countries.

Specifications are subject to change without notice.

The device characteristics and parameters in this data sheet can and do vary in different applications and actual device performance may vary over time. Users should verify actual device performance in their specific applications.