

\*RoHS COMPLIANT

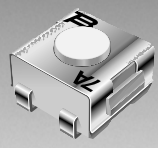

**BOURNS®**

## Features

- Compatible with most surface mount soldering processes
- Compatible with popular vacuum pick-and-place equipment
- J-hook, gull-wing & pinned configurations
- Sealed for board washing
- Meets EIA/EIAJ/IPC/VRCI SMD standard outline dimensions
- Top or side actuated
- RoHS compliant\*
- For switch applications/processing guidelines, [click here](#)

# 7914 4 mm SMD & Through-hole Sealed Key Switch

## Electrical Characteristics

Contact Rating  
 Maximum Current ..... 100 mA max.  
 Maximum Voltage ..... 16 V  
 Contact Resistance ..... 100 milliohms max.  
 Insulation Resistance .. 100 megohms min.  
 Dielectric Strength ..... 250 VAC

## General Characteristics

Switch Type ..... Normally open  
 Operating Temperature Range .....  
 ..... -55 °C to +125 °C  
 Storage Temperature Range .....  
 ..... -55 °C to +125 °C  
 Seal Test ..... 85 °C Fluorinert†  
 Vibration ..... 20 G  
 Shock ..... 100 G

## Mechanical Characteristics

Actuator Force ..... 300 ± 100 g  
 Pushover Strength (S Style) .....  
 ..... 0.9 kilograms minimum  
 Cycle life, loaded ..... 100,000 actuations  
 Contact resistance ..... 100 milliohms max.

## Physical Characteristics

Cover Material ..... Stainless steel  
 Base Material ..... Thermoplastic, UL94V-0  
 Terminal Material... Copper alloy gold plated  
 Dome Material... Stainless steel silver plated  
 Actuator Material ..... High temperature silicon rubber  
 Marking ..... Manufacturer's code and date code

## Packaging Options

J & G ..... 500 pcs./reel (MSL-1);  
 ..... 50 pcs./tube  
 S ..... 200 pcs./reel (MSL-1)  
 H ..... 50 pcs./tube

## How to Order

**7914 J - 1 - 000 E**

Model \_\_\_\_\_  
 Terminal \_\_\_\_\_  
 J = J-Hook H = Through-hole  
 G = Gull Wing S = Right Angle  
 Switch Type \_\_\_\_\_  
 1 = N.O. Au Contacts  
 Product Code for Button Height \_\_\_\_\_  
 "L" (For All Styles) from Top of Lid  
 000 = 1.65 mm  
 024 = 0.08 mm (Flush)  
 032 = 0.89 mm  
 050 = 2.67 mm (available in tube pack only for J, G & H Styles, tape & reel only for S Style)  
 Packaging Code (MSL-1) \_\_\_\_\_  
 Blank = Tube (for J, G & H Styles)  
 E = Plastic Embossed Tape & Reel (for J, G & S Styles)

Note: S Style is only available in tape and reel.

## Product Dimensions

**7914J J-Hook**

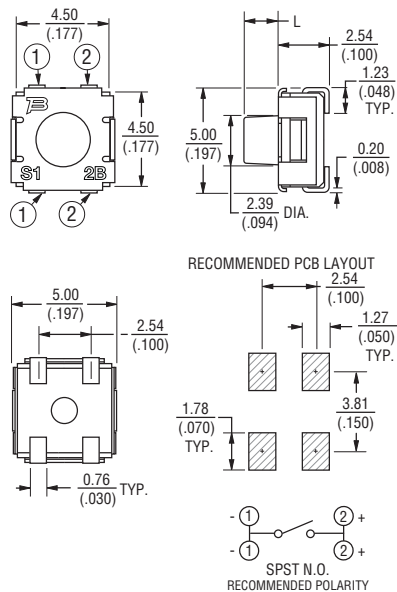

**7914H Through-hole**

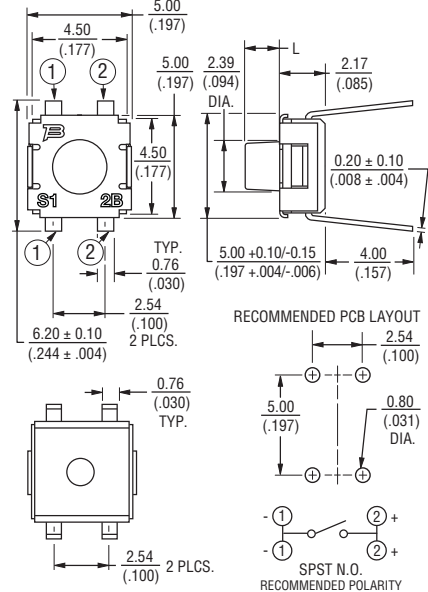

**7914G Gull Wing**

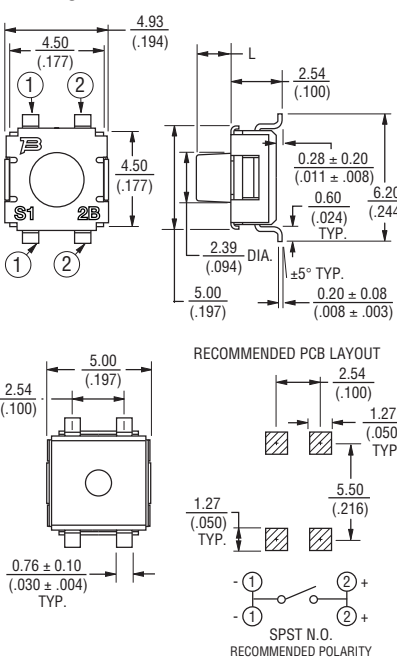

**7914S Right Angle**

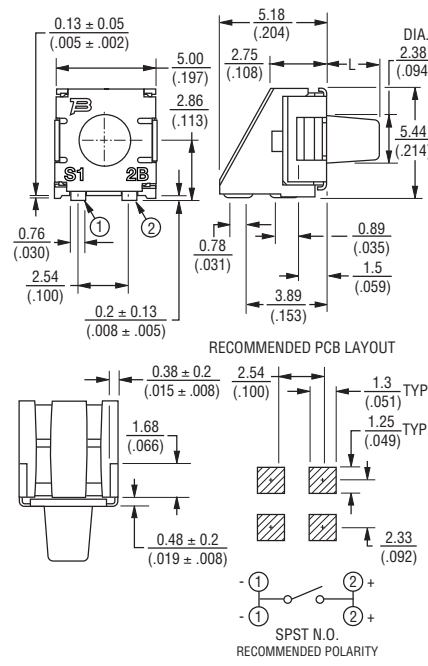

DIMENSIONS:  $\frac{\text{MM}}{\text{(INCHES)}}$  TOLERANCES:  $\pm 0.3$  (0.12)  
 EXCEPT WHERE NOTED.

\*RoHS Directive 2002/95/EC Jan. 27, 2003 including annex and RoHS Recast 2011/65/EU June 8, 2011.

†"Fluorinert" is a registered trademark of 3M Co. Specifications are subject to change without notice.

The device characteristics and parameters in this data sheet can and do vary in different applications and actual device performance may vary over time. Users should verify actual device performance in their specific applications.