

## Features

- Multiturn / Cermet / Industrial / Sealed
- Listed on the QPL per MIL-PRF-22097 and High-Rel MIL-PRF-39035
- For trimmer applications/processing guidelines, [click here](#)

# RJ26/RJR26 - 1/4" Trimpot® Trimming Potentiometer

## Electrical Characteristics

Standard Resistance Range ..... 10 to 1 megohm  
 (see standard resistance table)  
 Resistance Tolerance ..... ±10 % std.  
 Absolute Minimum Resistance  
 RJ26 ..... 2 % or 20 ohms max. (whichever is greater)  
 RJR26 ..... 2 % or 2 ohms max. (whichever is greater)  
 Contact Resistance Variation ..... 3.0 % or 3 ohms max. (whichever is greater)  
 Adjustability  
 Voltage ..... ±0.02 %  
 Resistance ..... ±0.05 %  
 Resolution ..... Infinite  
 Insulation Resistance ..... 500 vdc. 1,000 megohms min.  
 Dielectric Strength  
 Sea Level ..... 600 vac  
 80,000 Feet ..... 250 vac  
 Effective Travel ..... 12 turns nom.

## Environmental Characteristics

Power Rating (200 volts max.)  
 85 °C ..... 0.25 watt  
 150 °C ..... 0 watt  
 Temperature Range ..... -65 °C to +150 °C  
 Temperature Coefficient ..... ±100 ppm/°C  
 Seal Test ..... 85 °C Fluorinert\*  
 Humidity  
 RJ26 ..... MIL-STD-202 Method 106  
 96 hours (1 % ΔTR, 10 Megohms IR)  
 RJR26 ..... MIL-STD-202 Method 106  
 96 hours (1 % ΔTR, 100 Megohms IR)  
 Vibration ..... 20 G (1 % ΔTR; 1 % ΔVR)  
 Shock ..... 100 G (1 % ΔTR; 1 % ΔVR)  
 Load Life  
 RJ26..1,000 hours 0.25 watt @ 85 °C  
 (2 % ΔTR; 1 % ΔVR)  
 RJR26..10,000 hours 0.25 watt @ 85 °C  
 (3 % ΔTR)  
 Rotational Life ..... 200 cycles  
 (2 % ΔTR)

## Physical Characteristics

Torque ..... 3.0 oz-in. max.  
 Mechanical Stops ..... Wiper idles  
 Terminals ..... MIL-STD-202; Method 208  
 Weight ..... 0.015 oz.  
 Marking ..... Mil-spec part number  
 Wiper ..... 50 % (Actual TR) ±10 %  
 Flammability ..... U.L. 94V-0  
 Standard Packaging ..... 50 pcs. per tube  
 Adjustment Tool ..... H-90

REV. 04/14

"Trimpot" is a registered trademark of Bourns, Inc. Specifications are subject to change without notice. The device characteristics and parameters in this data sheet can and do vary in different applications and actual device performance may vary over time. Users should verify actual device performance in their specific applications.

## Product Dimensions

RJ26FW / RJR26FW

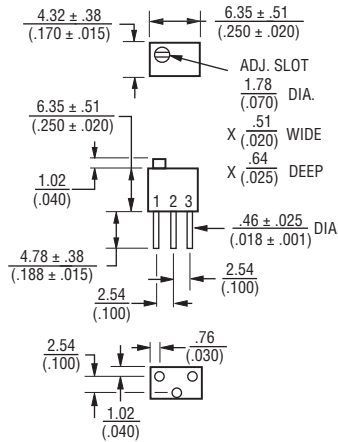

RJ26FX / RJR26FX

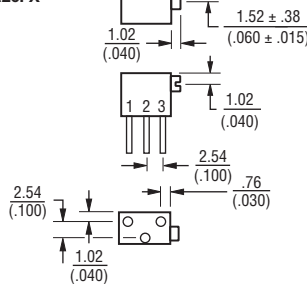

RJ26FP / RJR26FP

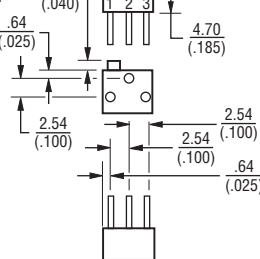

## Standard Resistance Table

Resistance (Ohms)	Resistance Code	Resistance (Ohms)	Resistance Code
10	100	10,000	103
20	200	20,000	203
50	500	25,000	253
100	101	50,000	503
200	201	100,000	104
500	501	200,000	204
1,000	102	250,000	254
2,000	202	500,000	504
5,000	502	1,000,000	105

RJR26FA

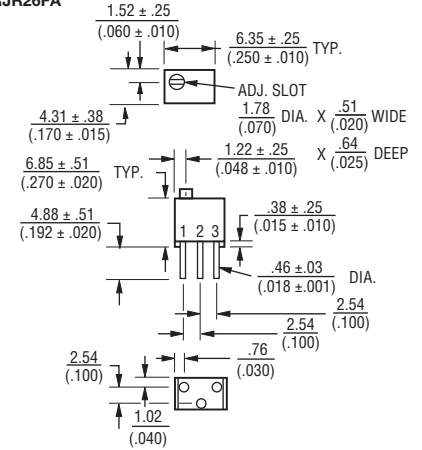

RJR26FB

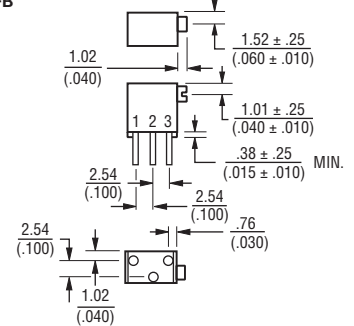

DIMENSIONS:  $\frac{\text{MM}}{\text{(INCHES)}}$   
 TOLERANCES: ±  $\frac{0.25}{(.010)}$  EXCEPT WHERE NOTED

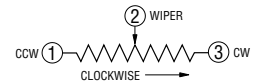

## How To Order

MIL-PRF-22097 **RJ26 F W 202**  
 Model \_\_\_\_\_  
 Characteristic \_\_\_\_\_  
 F = ±100 ppm/°C Temp. Coeff. Max.  
 Terminal Style \_\_\_\_\_  
 Resistance Code \_\_\_\_\_

## How To Order

MIL-PRF-39035 **RJR26 F W 204 P**  
 Model \_\_\_\_\_  
 Characteristic \_\_\_\_\_  
 F = ±100 ppm/°C Temp. Coeff. Max.  
 Terminal Style \_\_\_\_\_  
 Resistance Code \_\_\_\_\_  
 Failure Rate  
 M = 1.0 %  
 P = 0.1 %  
 R = 0.01 %