

\*RoHS COMPLIANT

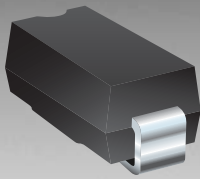

**BOURNS®**

## Features

- RoHS compliant\*
- Glass passivated chip
- Low reverse leakage current
- Low forward voltage drop
- High current capability

## CD214A-F150~F1600 Fast Response Rectifiers

### General Information

The markets of portable communications, computing and video equipment are challenging the semiconductor industry to develop increasingly smaller electronic components. Bourns offers Glass Passivated Rectifiers for rectification applications, in compact chip DO-214AC (SMA) size format, which offer PCB real estate savings and are considerably smaller than most competitive parts. The Glass Passivated Rectifier Diodes offer a forward current of 1.0 A with a choice of repetitive peak reverse voltage of 50 V up to 600 V.

Bourns® Chip Diodes conform to JEDEC standards, are easy to handle on standard pick and place equipment and their flat configuration minimizes roll away.

### Electrical Characteristics (@ T<sub>A</sub> = 25 °C Unless Otherwise Noted)

Parameter	Symbol	CD214A-						Unit
		F150	F1100	F1150	F1200	F1400	F1600	
Maximum Repetitive Peak Reverse Voltage	V <sub>RRM</sub>	50	100	150	200	400	600	V
Maximum RMS Voltage	V <sub>RMS</sub>	35	70	105	140	280	420	V
Maximum DC Blocking Voltage	V <sub>DC</sub>	50	100	150	200	400	600	V
Maximum Average Forward Rectified Current <sup>1</sup>	I <sub>(AV)</sub>	1.0						A
DC Reverse Current @ Rated DC Blocking Voltage (@T <sub>A</sub> = 25 °C)	I <sub>R</sub>	5.0						μA
DC Reverse Current @ Rated DC Blocking Voltage (@T <sub>A</sub> = 125 °C)	I <sub>R</sub>	50.0						μA
Typical Junction Capacitance <sup>2</sup>	C <sub>J</sub>	10						pF
Maximum Instantaneous Forward Voltage @ 1 A	V <sub>F</sub>	0.95			1.25		1.7	V
Typical Thermal Resistance <sup>3</sup>	R <sub>θJA</sub>	34						°C/W
Peak forward surge current 8.3 ms single half sine-wave superimposed on rated load (JEDEC Method)	I <sub>FSM</sub>	30					25	A
Maximum Reverse Recovery Time <sup>4</sup>	T <sub>rr</sub>	25					35	ns
Typical Reverse Recovery Time <sup>4</sup>	T <sub>rr</sub>	20					30	ns

Notes:

1 See Forward Derating Curve.

2 Measured at 1 MHz and an applied reverse voltage of 4.0 V.

3 Thermal resistance from junction to ambient and from junction to lead P.C.B. mounted on 0.2 x 0.2" (5.0 x 5.0 mm) copper pad areas.

4 Reverse recovery test condition: I<sub>F</sub> 0.5 A, I<sub>R</sub> = 1.0 A, I<sub>rr</sub> = 0.25 A.

### Thermal Characteristics (@ T<sub>A</sub> = 25 °C Unless Otherwise Noted)

Parameter	Symbol	CD214A-F150~F1600	Unit
Operating Temperature Range	T <sub>J</sub>	-55 to +150	°C
Storage Temperature Range	T <sub>STG</sub>	-55 to +150	°C

\*RoHS Directive 2002/95/EC Jan. 27, 2003 including annex and RoHS Recast 2011/65/EU June 8, 2011.

Specifications are subject to change without notice.

Customers should verify actual device performance in their specific applications.

# CD214A-F150~F1600 Fast Response Rectifiers

**BOURNS®**

## Product Dimensions

This is an RoHS compliant product using 100 % Sn termination. It is a molded plastic package. A cathode band indicates the polarity. The package weighs approximately 0.064 g. The package and dimensions are shown below.

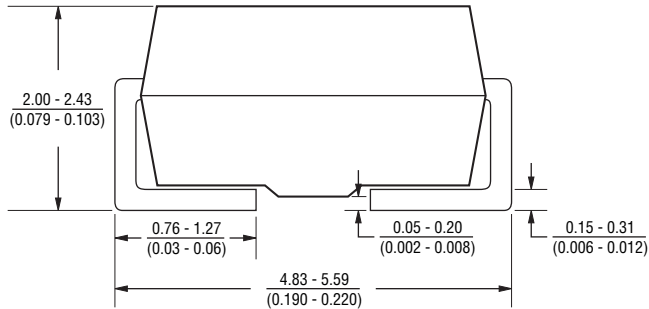
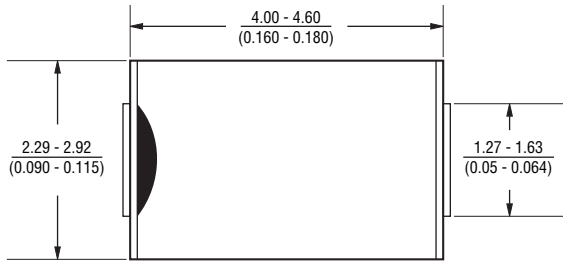

DIMENSIONS:  $\frac{\text{MM}}{\text{(INCHES)}}$

## Recommended Pad Layout

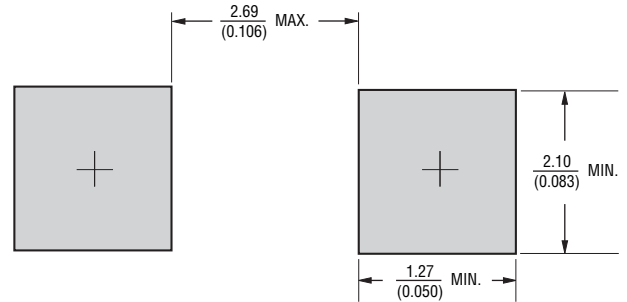

DIMENSIONS:  $\frac{\text{MM}}{\text{(INCHES)}}$

## How To Order

	<b>CD 214A - F 1 400</b>
Common Code	_____
CD = Chip Diode	_____
Package	_____
214A = DO214AC	_____
Model Series	_____
F = Fast Response	_____
Forward Current	_____
1 = 1 A	_____
Reverse Voltage	_____
50 = 50 V	_____
100 = 100 V	_____
150 = 150 V	_____
200 = 200 V	_____
400 = 400 V	_____
600 = 600 V	_____

## Typical Part Marking

CD214A-F150 .....	<b>F1A</b>
CD214A-F1100 .....	<b>F1B</b>
CD214A-F1150 .....	<b>F1C</b>
CD214A-F1200 .....	<b>F1D</b>
CD214A-F1400 .....	<b>F1G</b>
CD214A-F1600 .....	<b>F1J</b>

# CD214A-F150~F1600 Fast Response Rectifiers



## Performance Graphs

### Forward Current Derating Curve

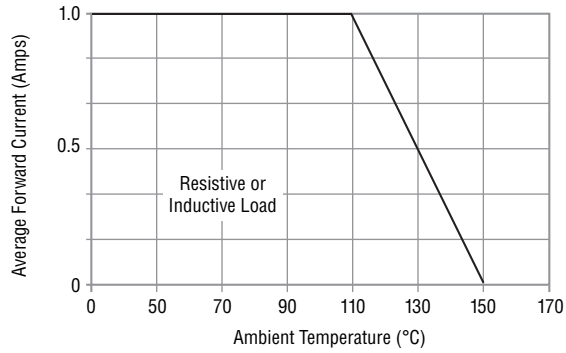

### Maximum Non-Repetitive Surge Current

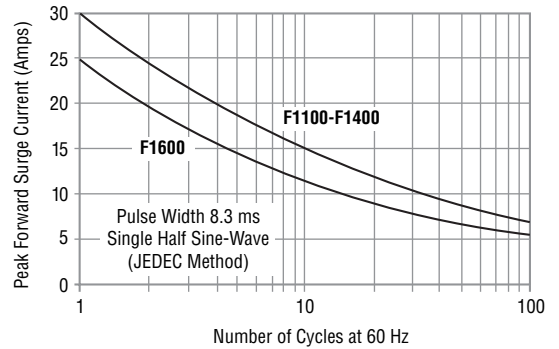

### Typical Forward Characteristics

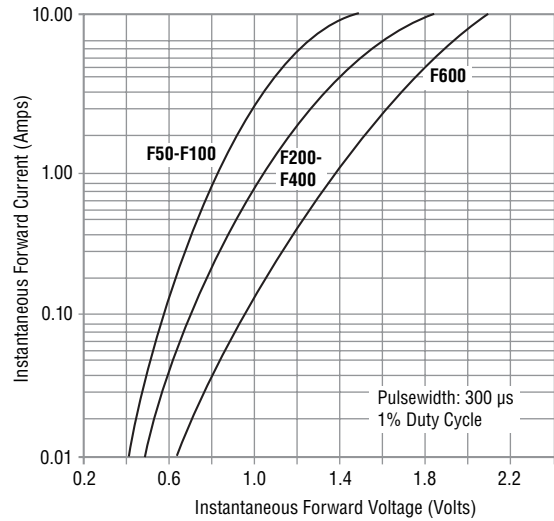

### Typical Reverse Characteristics

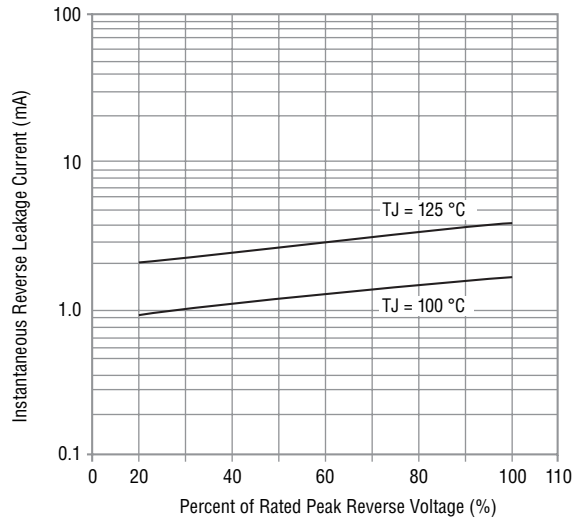

### Typical Junction Capacitance

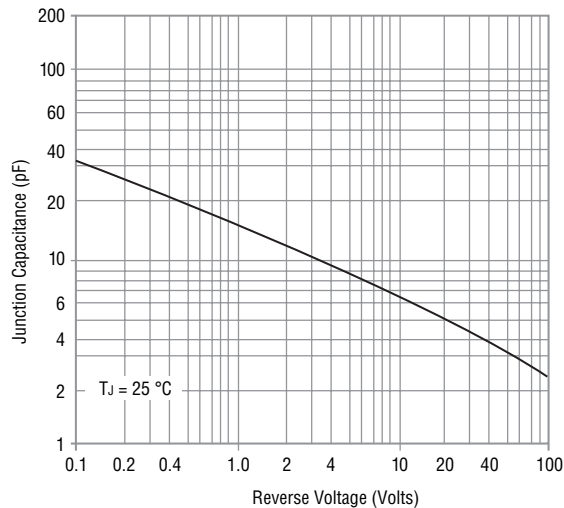

# CD214A-F150~F1600 Fast Response Rectifiers

**BOURNS®**

## Packaging Information

The surface mount product is packaged in a 12 mm x 4 mm tape and reel format per EIA-481 standard.

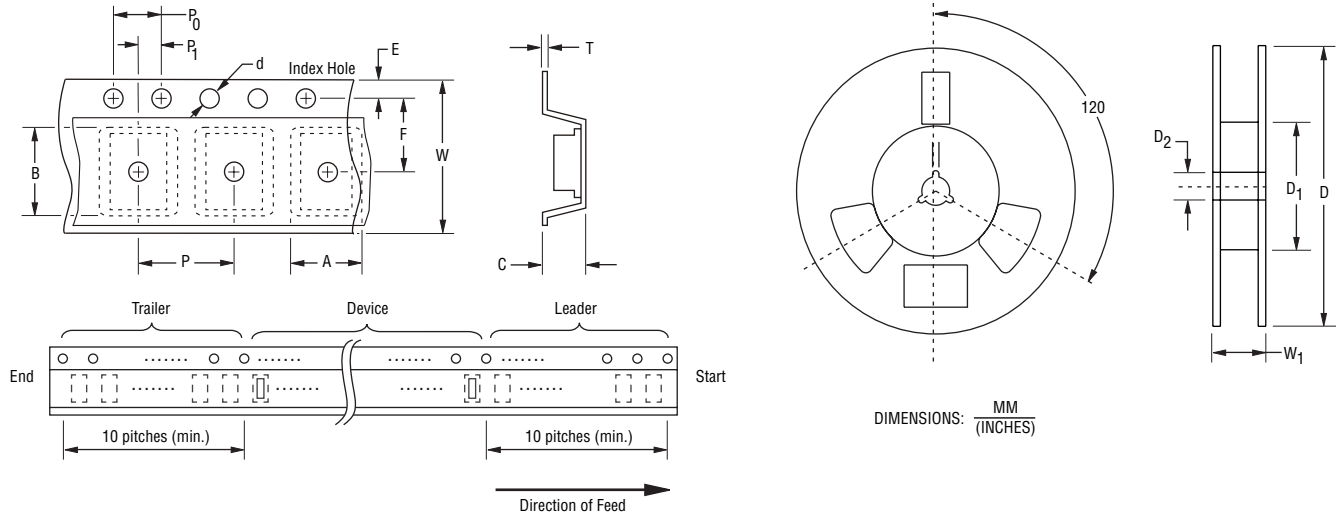

DIMENSIONS:  $\frac{\text{MM}}{\text{(INCHES)}}$

Item	Symbol	DO-214AC (SMA)
Carrier Width	A	$\frac{3.42 \pm 0.10}{(0.134 \pm 0.004)}$
Carrier Length	B	$\frac{5.07 \pm 0.10}{(0.199 \pm 0.004)}$
Carrier Depth	C	$\frac{3.10 \pm 0.10}{(0.122 \pm 0.004)}$
Sprocket Hole	d	$\frac{1.55 \pm 0.05}{(0.061 \pm 0.002)}$
Reel Outside Diameter	D	$\frac{330}{(12.992)}$
Reel Inner Diameter	D <sub>1</sub>	$\frac{50.0}{(1.969)}$ Min.
Feed Hole Diameter	D <sub>2</sub>	$\frac{13.0 \pm 0.50}{(0.512 \pm 0.020)}$
Sprocket Hole Position	E	$\frac{1.75 \pm 0.10}{(0.069 \pm 0.004)}$
Punch Hole Position	F	$\frac{5.50 \pm 0.50}{(0.217 \pm 0.020)}$
Punch Hole Pitch	P	$\frac{4.00 \pm 0.10}{(0.157 \pm 0.004)}$
Sprocket Hole Pitch	P <sub>0</sub>	$\frac{4.00 \pm 0.10}{(0.157 \pm 0.004)}$
Embossment Center	P <sub>1</sub>	$\frac{2.00 \pm 0.05}{(0.079 \pm 0.002)}$
Overall Tape Thickness	T	$\frac{0.30 \pm 0.10}{(0.012 \pm 0.004)}$
Tape Width	W	$\frac{12.00 \pm 0.20}{(0.420 \pm 0.008)}$
Reel Width	W <sub>1</sub>	$\frac{18.7}{(0.736)}$ Max.
Quantity per Reel	—	7,500

**BOURNS®**

**Asia-Pacific:**

Tel: +886-2 2562-4117 • Fax: +886-2 2562-4116

**Europe:**

Tel: +41-41 768 5555 • Fax: +41-41 768 5510

**The Americas:**

Tel: +1-951 781-5500 • Fax: +1-951 781-5700

[www.bourns.com](http://www.bourns.com)