

Features

- Lead free device (RoHS Compliant*)
- Protects 8 lines
- Unidirectional & bidirectional configurations
- ESD protection

Applications

- Audio/video inputs
- RS-232, RS-422 & RS-423 data lines
- Portable electronics
- Medical sensors

CDNBS16-T03~T36C – TVS Diode Array Series

General Information

The markets of portable communications, computing and video equipment are challenging the semiconductor industry to develop increasingly smaller electronic components.

Bourns offers Transient Voltage Suppressor Array diodes for surge and ESD protection applications, in 16 Lead Narrow Body SOIC package size format. The Transient Voltage Suppressor Array series offer a choice of voltage types ranging from 3 V to 36 V in unidirectional and bidirectional configurations. Bourns® Chip Diodes conform to JEDEC standards, are easy to handle on standard pick and place equipment and their flat configuration minimizes roll away.

The Bourns® device will meet IEC 61000-4-2 (ESD), IEC 61000-4-4 (EFT) and IEC 61000-4-5 (Surge) requirements.

Thermal Characteristics (@ T_A = 25 °C Unless Otherwise Noted)

Parameter	Symbol	Max.	Unit
Operating Temperature	T _J	-55 to +150	°C
Storage Temperature	T _{STG}	-55 to +150	°C

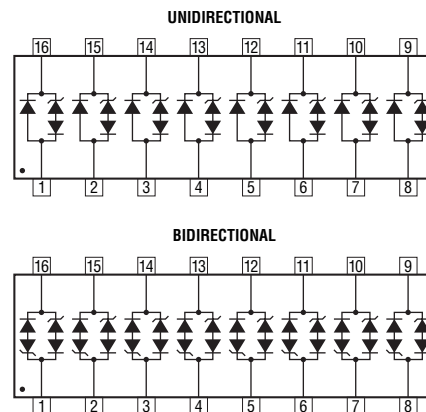

Electrical Characteristics (@ T_A = 25 °C Unless Otherwise Noted)

Parameter	Symbol	CDNBS16-														Unit
		Uni-	Bi-	Uni-	Bi-	Uni-	Bi-	Uni-	Bi-	Uni-	Bi-	Uni-	Bi-	Uni-	Bi-	
		T03	T03C	T05	T05C	T08	T08C	T12	T12C	T15	T15C	T24	T24C	T36	T36C	
Minimum Breakdown Voltage @ 1 mA	V _{BR}	4.5		6.0		8.5		13.3		16.7		26.7		40.0		V
Working Peak Voltage	V _{WM}	3.0		5.0		8.0		12.0		15.0		24.0		36.0		V
Maximum Clamping Voltage V _C @ I _p = 1 A ¹	V _C	8.0		9.8		13.4		19.0		25.5		40.0		53.0		V
Maximum Clamping Voltage @ 8/20 μs V _C @ I _{pp} ¹	V _C	23 V @ 43 A		24 V @ 42 A		26 V @ 30 A		33 V @ 21 A		39 V @ 15 A		57 V @ 10 A		72 V @ 7 A		V
Maximum Leakage Current @ V _{WM}	I _D	125		20		10		2		2		2		2		μA
Maximum Capacitance @ 0 V, 1 MHz	C _{j(SD)}	15														pF
Temperature Coefficient of V _{BR}		-3		3		9		16		17		26		36		mV/°C
Peak Pulse Power (t _p = 8/20 μs) ²	P _{PP}	500														W
Forward Voltage @ 100 mA, 300 μs – Square Wave ³	V _F	1.5														V

Notes:

1. See Pulse Wave Form.
2. See Peak Pulse Power vs. Pulse Time.
3. Only applies to unidirectional devices.
4. Part numbers with a "C" suffix are bidirectional devices, i.e., CDNBS16-T03C.

*RoHS Directive 2002/95/EC Jan 27, 2003 including Annex.

Specifications are subject to change without notice.

Customers should verify actual device performance in their specific applications.

CDNBS16-T03~T36C – TVS Diode Array Series



Performance Graphs

Peak Pulse Power vs Pulse Time

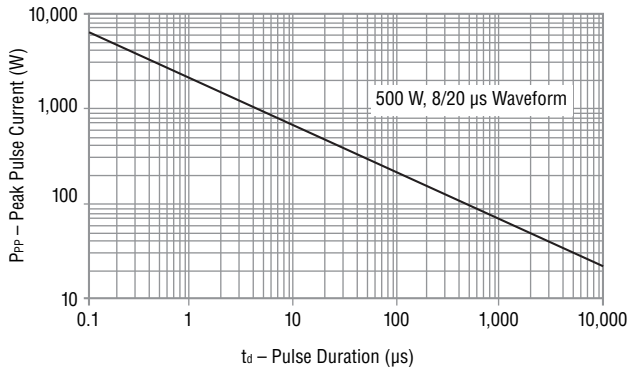

Pulse Wave Form

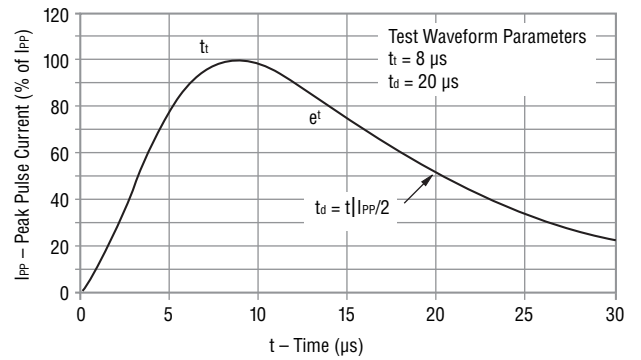

Block Diagram

The device block diagrams below include the pin names and basic electrical connections associated with each channel.

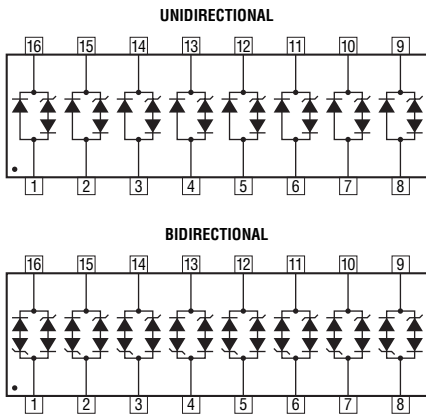

Power Derating Curve

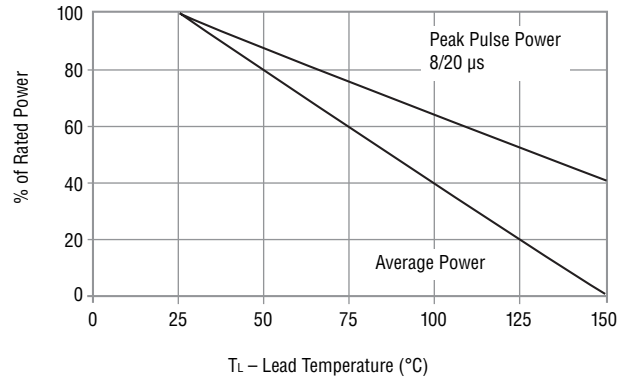

Device Pinout

Pin	Function	Pin	Function
1	GND	9	I/O 1
2	GND	10	I/O 2
3	GND	11	I/O 3
4	GND	12	I/O 4
5	GND	13	I/O 5
6	GND	14	I/O 6
7	GND	15	I/O 7
8	GND	16	I/O 8

Specifications are subject to change without notice.
Customers should verify actual device performance in their specific applications.

CDNBS16-T03~T36C – TVS Diode Array Series

BOURNS®

Packaging Specifications

The product will be dispensed in Tape and Reel format (see diagram below).

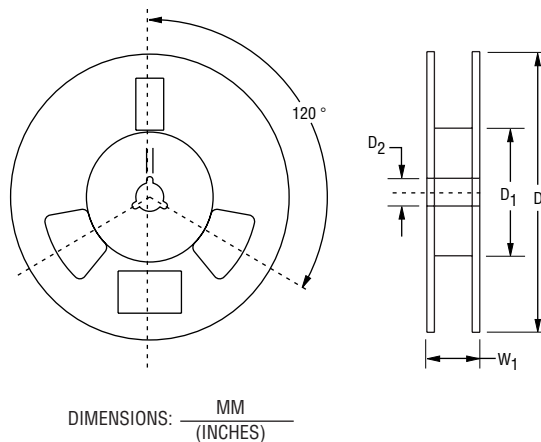
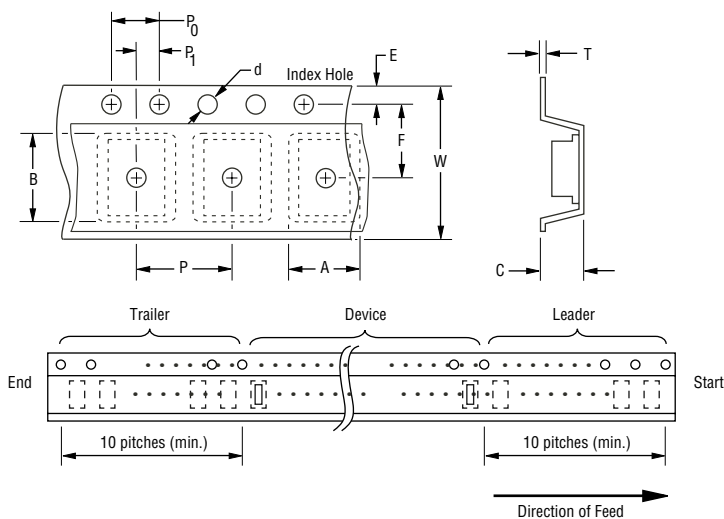

Devices are packed in accordance with EIA standard RS-481-A.

Item	Symbol	NSOIC 16L
Carrier Width	A	$\frac{6.7 \pm 0.10}{(0.264 \pm 0.004)}$
Carrier Length	B	$\frac{10.5 \pm 0.10}{0.413 \pm 0.004}$
Carrier Depth	C	$\frac{2.10 \pm 0.10}{0.083 \pm 0.004}$
Sprocket Hole	d	$\frac{1.55 \pm 0.05}{(0.061 \pm 0.002)}$
Reel Outside Diameter	D	$\frac{330}{(12.992)}$
Reel Inner Diameter	D ₁	$\frac{80.0}{(3.1500)}$ MIN.
Feed Hole Diameter	D ₂	$\frac{13.0 \pm 0.20}{(0.512 \pm 0.008)}$
Sprocket Hole Position	E	$\frac{1.75 \pm 0.10}{(0.069 \pm 0.004)}$
Punch Hole Position	F	$\frac{3.50 \pm 0.05}{(0.138 \pm 0.002)}$
Punch Hole Pitch	P	$\frac{8.00 \pm 0.10}{(0.315 \pm 0.004)}$
Sprocket Hole Pitch	P ₀	$\frac{4.00 \pm 0.10}{(0.157 \pm 0.004)}$
Embossment Center	P ₁	$\frac{2.00 \pm 0.05}{(0.079 \pm 0.002)}$
Overall Tape Thickness	T	$\frac{0.20 \pm 0.10}{(0.008 \pm 0.004)}$
Tape Width	W	$\frac{16.00 \pm 0.20}{(0.630 \pm 0.008)}$
Reel Width	W ₁	$\frac{18.4}{(0.724)}$ MAX.
Quantity per Reel	-	2500

REV. 07/11

Specifications are subject to change without notice.
Customers should verify actual device performance in their specific applications.