

7000 Series Miniature Toggle Switches

Features/Benefits

- Multi-pole and multi-position
- Wide variety of actuator and termination options
- Epoxy terminal-seal compatible with bottom wash cleaning
- RoHS complaint models available

Typical Applications

- Telecommunications
- Instrumentation
- Medical equipment



Specifications

CONTACT RATING: B contact material: 0.4 VA max. @ 20 V AC or DC max. Q contact material: 5 AMPS @ 120 V AC or 28 V DC; 2 AMPS @ 250 V AC. See page F-15 for additional ratings.

ELECTRICAL LIFE: 7X01 and UX1 models: 100,000 make-and-break cycles at full load. All other models: 40,000 cycles.

CONTACT RESISTANCE: Below 10 m Ω typ. initial @ 2-4 V DC, 100 mA, for both silver and gold plated contacts.

INSULATION RESISTANCE: 10⁹ Ω min.

DIELECTRIC STRENGTH: 1000 Vrms min. @ sea level.

OPERATING TEMPERATURE: -30°C to 85°C.

SOLDERABILITY: Per MIL-STD-202F method 208D, or EIA RS-186E method 9 (1 hour steam aging).

For materials see page F-4.

NOTE: Any models supplied with P, S, R, Q, B or G contact material are RoHS compliant and compatible.

NOTE: Specifications listed above are for switches with standard options. For information on specific and custom switches, consult Customer Service Center.

Build-A-Switch

To order, simply select desired option from each category and place in the appropriate box. Available options are shown and described on pages F-4 thru F-16. For additional options not shown in catalog, consult our Customer Service Center.

| | | | |
|--|--|---|--|
| <p>Switch Function</p> <p>7101 SP On-None-On 7103 SP On-Off-On 7105 SP Mom.-Off-Mom. 7107 SP On-Off-Mom. 7108 SP On-None-Mom. 7109 SP None-On-Mom. 7201 DP On-None-On 7203 DP On-Off-On 7205 DP Mom.-Off-Mom. 7207 DP On-Off-Mom. 7208 DP On-None-Mom. 7211 DP On-On-On 7213 DP On-On-Mom. 7215 DP Mom.-On-Mom. 7301 3P On-None-On 7303 3P On-Off-On 7305 3P Mom.-Off-Mom. 7308 3P On-None-Mom. 7401 4P On-None-On 7403 4P On-Off-On 7405 4P Mom.-Off-Mom. 7408 4P On-None-Mom. 7411 4P On-On-On 7413 4P On-On-Mom. 7415 4P Mom.-On-Mom.</p> <p><small>Note: UL models available, see pages F-4 & F-5.</small></p> | <p>Actuator</p> <p>M .200" high P3 Flatted, anti-rotation, .450" high S .420" high T .687" high, 15/32 bushing K2 Locking lever, .704" high K9 Locking lever, .704" high K12 Locking lever, .732" high K19 Locking lever, .732" high L .840" high L1 .640" high L1P Anti-rotation, .640" high L2 .550" high L2P Anti-rotation, .550" high L3 Plastic .940" inch L40 Lever handle without cap L41 .531" high lever handle with cap L42 .838" high lever handle with cap MP Anti-rotation, .200" high P1 Flatted, anti-rotation, .840" high P4 Flatted, anti-rotation, .250" high SP Anti-rotation, .420" high T1 .487" high, 15/32 bushing T1P Anti-rotation, .487" high, 15/32 bushing T2P Flatted, anti-rotation, .610" high, 15/32 bushing TP Anti-rotation, .687" high, 15/32 bushing</p> | <p>Bushing</p> <p>D .280 high, keyway H .296 high, flat Y .350 high, keyway NONE No bushing choice required CW Splashproof D8 .280" high, flat D9 .280" high, keyway H3 .315" high, keyway H4 8mm high, keyway Y1 .378" high, keyway Y3 8.9mm high, keyway Y4 .378" high, flat Y9 .350" high, keyway</p> <p>Terminations</p> <p>A Right angle, PC thru-hole AV2 Vert. right angle, PC thru-hole C PC Thru-hole V3 .460 high, V-bracket Z Solder lug A2 Right angle, PC thru-hole A3 Right angle, PC thru-hole A4 Right angle, PC thru-hole AW1 Right angle, extended, PC thru-hole AW4 Right angle, extended, PC thru-hole V2 .555" high, V-bracket V4 .630" high, V-bracket V6 .460" high, V-bracket V7 .630" high, V-bracket V8 .953" high, V-bracket V9 1.150" high, V-bracket V21 .555" high, snap-in V-bracket V31 .460" high, snap-in V-bracket V41 .630" high, snap-in V-bracket V71 .630" high, snap-in V-bracket V81 .953" high, snap-in V-bracket</p> | <p>Contact Material</p> <p>B Gold P Gold, matte-tin Q Silver S Silver, matte-tin G Gold over silver R Gold over silver, matte-tin</p> <p>Seal</p> <p>E Epoxy I Epoxy potted base</p> <p>Actuator Color/Finish</p> <p>NONE Bright chrome 2 Black 3 Red S Satin chrome</p> <p>KXX Actuator Color/Finish</p> <p>NONE Natural aluminum 2 Black anodized aluminum 3 Red anodized aluminum 7 Blue anodized aluminum</p> <p>Bushing Finish</p> <p>NONE Nickel on all bushings (except D8, satin chrome) 2 Black</p> |
|--|--|---|--|



Dimensions are shown: Inches (mm)
Specifications and dimensions subject to change



Toggle

7000 Series Miniature Toggle Switches

Materials

CASE: Glass filled nylon 6/6, flame retardant, heat stabilized, or diallyl phthalate (DAP) (UL 94V-0).

ACTUATOR: Brass, chrome plated.

BUSHING: Brass or zinc, nickel plated.

HOUSING: Stainless steel.

SWITCH SUPPORT: Brass or steel, tin plated.

END CONTACTS: B contact material: Copper alloy, with gold plate over nickel plate. Q contact material: Coin silver, silver plated. See page F-15 for additional contact materials.

CENTER CONTACTS & ALL TERMINALS: B contact material: Copper alloy, with gold plate over nickel plate. Q contact material: Copper alloy, silver plated. See above for additional contact materials.

TERMINAL SEAL: Epoxy.

HARDWARE: Nut & Locking Ring: Brass, nickel plated.

Lockwasher: Steel, nickel plated.

NOTE: Materials listed above are for switches with standard options. For information on specific and custom switches, consult Customer Service Center.

SWITCH FUNCTION

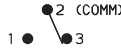
| NO. POLES | MODEL NO. | UL** MODEL NO. | SWITCH FUNCTION | | | CONNECTED TERMINALS | | | SCHEMATIC |
|-----------|-------------|----------------|------------------|------------------|------------------|---------------------|------------------|------------------|---|
| | | | POS. 1 KEYWAY | POS. 2 KEYWAY | POS. 3 KEYWAY | POS. 1 KEYWAY | POS. 2 KEYWAY | POS. 3 KEYWAY | |
| SP | 7101 | U11 | ON | NONE | ON | 2-3 | N/A | 2-1 |  |
| | 7103 | U13 | ON | OFF | ON | 2-3 | OPEN | 2-1 | |
| | 7105 | U15 | MOM. | OFF | MOM. | | | | |
| | 7107 | U17 | ON | OFF | MOM. | | | | |
| | 7108 | U18 | ON | NONE | MOM. | 2-3 | N/A | 2-1 | |
| | 7109 | U19 | NONE | ON | MOM. | N/A | 2-3 | 2-1 | |

SPDT

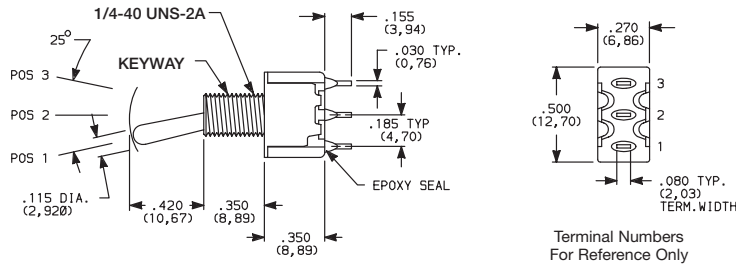

| | | | | | | | | | |
|----|--------------|--------------|------|------|------|---------|---------|---------|---|
| DP | 7201 | U21 | ON | NONE | ON | 2-3,5-6 | N/A | 2-1,5-4 |  |
| | 7203 | U23 | ON | OFF | ON | 2-3,5-6 | OPEN | 2-1,5-4 | |
| | 7205 | U25 | MOM. | OFF | MOM. | | | | |
| | 7207 | U27 | ON | OFF | MOM. | | | | |
| | 7208 | U28 | ON | NONE | MOM. | 2-3,5-6 | N/A | 2-1,5-4 | |
| | 7211* | U211* | ON | ON | ON | 2-3,5-6 | 2-3,5-4 | 2-1,5-4 | |
| | 7213* | U213* | ON | ON | MOM. | | | | |
| | 7215* | U215* | MOM. | ON | MOM. | | | | |

DPDT



MOM. = Momentary

** U11-U415 model nos.



with all options when ordered with G, R, Q or S contact material.

* Wiring for 3-way switch, see Section N.









Third Angle
Projection

Dimensions are shown: Inches (mm)
Specifications and dimensions subject to change



7000 Series Miniature Toggle Switches

SWITCH FUNCTION

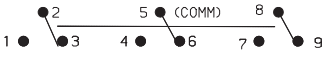
| NO. POLES | MODEL NO. | UL** MODEL NO. | SWITCH FUNCTION | | | CONNECTED TERMINALS | | | SCHEMATIC |
|-----------|-------------|----------------|---|---|---|---|---|---|---|
| | | | POS. 1 | POS. 2 | POS. 3 | POS. 1 | POS. 2 | POS. 3 | |
| | | |  |  |  |  |  |  | |
| 3P | 7301 | U31 | ON | NONE | ON | 2-3,5-6,8-9 | N/A | 2-1,5-4,8-7 |  |
| | 7303 | U33 | ON | OFF | ON | 2-3,5-6,8-9 | OPEN | 2-1,5-4,8-7 | |
| | 7305 | U35 | MOM. | OFF | MOM. | | | | |
| | 7307 | U37 | ON | OFF | MOM. | | | | |
| | 7308 | U38 | ON | NONE | MOM. | 2-3,5-6,8-9 | N/A | 2-1,5-4,8-7 | |

3PDT

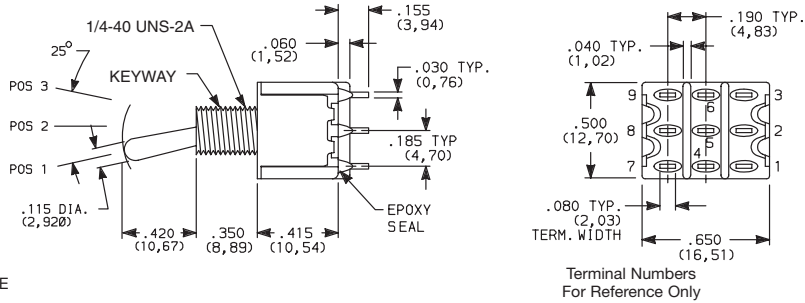

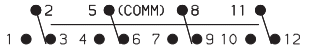
| | | | | | | | | | |
|----|--------------|--------------|------|------|------|-------------------|-------------------|-------------------|---|
| 4P | 7401 | U41 | ON | NONE | ON | 2-3,5-6,8-9,11-12 | N/A | 2-1,5-4,8-7,11-10 |  |
| | 7403 | U43 | ON | OFF | ON | 2-3,5-6,8-9,11-12 | OPEN | 2-1,5-4,8-7,11-10 | |
| | 7405 | U45 | MOM. | OFF | MOM. | | | | |
| | 7408 | U48 | ON | NONE | MOM. | 2-3,5-6,8-9,11-12 | N/A | 2-1,5-4,8-7,11-10 | |
| | 7411* | U411* | ON | ON | ON | 2-3,5-6,8-9,11-12 | 2-3,5-4,8-9,11-10 | 2-1,5-4,8-7,11-10 | |
| | 7413* | U413* | ON | ON | MOM. | | | | |
| | 7415* | U415* | MOM. | ON | MOM. | | | | |

4PDT

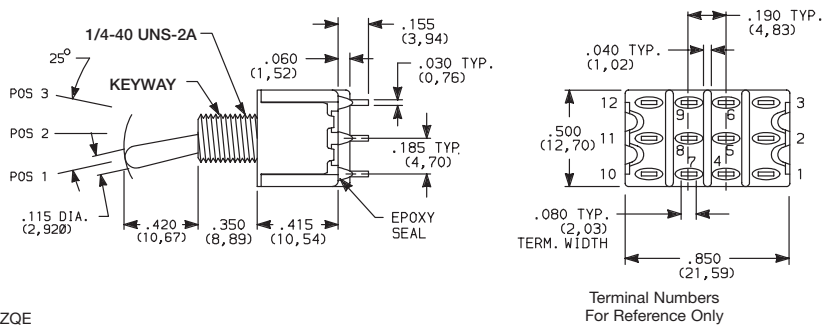

MOM. = Momentary

Wiring for 3-way switch, see Section N.

** U11-U415 model nos.  with all options when ordered with G, Q, R or S contact material.

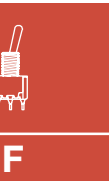

7000 Series Miniature Toggle Switches

ACTUATOR

S .420" HIGH ¹
SP ANTIROTATION, .420" HIGH ^{2,3}

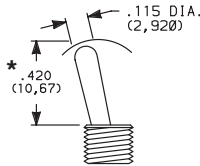

S actuator standard when ordered with C, W-W5, Z & Z3 terminations. Caps are available separately, see page F-16.

M .200" HIGH ¹
MP ANTIROTATION, .200" HIGH ^{2,3}

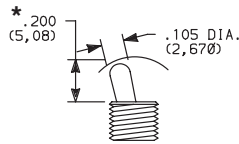

M actuator standard when ordered with all terminations except C, W-W5, Z & Z3. Caps are available separately, see page F-16.

L, L1, L2 .840", .640", .550" HIGH ¹
L1P, L2P ANTIROTATION, .840", .640", .550" HIGH ^{2,3}

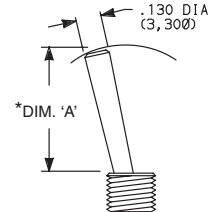

| OPTION CODE | DIM 'A' |
|-------------|--------------|
| L | .840 (21,34) |
| L1, L1P | .640 (16,26) |
| L2, L2P | .550 (13,97) |

Caps are available separately, see page F-16.

***P1** FLATTED WITH ANTIROTATION, .840" HIGH ^{2,3}



***P3** FLATTED WITH ANTIROTATION, .450" HIGH ^{2,3}



***P4** FLATTED WITH ANTIROTATION, .250" HIGH ^{2,3}

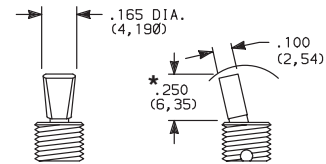

*Dress nut part number 709901201 supplied standard with threaded bushing. (Part number 709903201 with metric threaded bushings.)

T .687 (17,45) HIGH ^{1,2}
TP ANTIROTATION, .687 (17,45) HIGH, 15/32 BUSHING ^{1,2,3}



T1 .487 (12,37) HIGH ^{1,2}
T1P ANTIROTATION, .487 (12,37) HIGH, 15/32 BUSHING ^{1,2,3}



T2P FLATTED, ANTIROTATION, .610" HIGH, 15/32 BUSHING ^{1,2,3}



Bushing option code not required unless CW splashproof bushing ordered. TP & T1P actuators not available with CW splashproof bushing. All TXX actuators not available on single pole models with A-A4, AW1-AW4 terminations.

Bushing option code not required. T2P actuator not available with CW splashproof bushing or single pole models with A-A4, AW1-AW4 terminations.

Toggle F

- ¹ L, L1, L2, M, S & TXX actuators not available with Y1 bushing.
- ² L1P, L2P, MP, P1, P3, P4, SP & TXX actuators not available with D8 & H4 bushing.
- ³ Antirotation: Provides anti-'push-in' feature on actuator.
- * Add .070 (1,78) for D, D8 & D9 bushings, subtract .020 (0,51) for H3 bushing.

| OPTION CODE | ACTUATOR FINISH |
|-------------|--|
| NONE | BRIGHT CHROME-With Nickel Plated Bushing |
| 2 | BLACK |
| S | SATIN CHROME |

NOTE: Black hardware is supplied when either black actuators or bushings are specified. For additional hardware, see Section N.



Dimensions are shown: Inches (mm)
 Specifications and dimensions subject to change



7000 Series Miniature Toggle Switches

ACTUATOR



- K2** LOCKING LEVER, .704" HIGH (threaded)
K9 LOCKING LEVER, .704" HIGH (unthreaded)

- K12** LOCKING LEVER, .732" HIGH (threaded)
K19 LOCKING LEVER, .732" HIGH (unthreaded)



Replaces K, K8



Replaces K1, K18

| OPTION CODE | ACTUATOR CAP FINISH |
|-------------|---|
| NONE | NATURAL ALUMINUM—With Nickel Plated Bushing |
| 2 | BLACK ANODIZED ALUMINUM |
| 3 | RED ANODIZED ALUMINUM |
| 7 | BLUE ANODIZED ALUMINUM |

* All KXX models including KXXCW have a keyway

Locking Positions



-01 Models
2 Position lock



-03 & -11 Models
3 Position lock



-05, -09 & -15 Models
1 Position lock



-07 & -13 Models
2 Position lock



-08 Models
1 Position lock

NOTE: To prevent accidental actuation, toggle must be lifted before being actuated. When released, toggle will lock in place. Overtightening mounting nut may cause actuator to bind.

Locking levers supplied with bushing shown.

Bushing option code not required unless CW splashproof bushing ordered.

- L40** LEVER HANDLE WITHOUT CAP



No color choice required

- L41** PLASTIC LEVER HANDLE WITH ANTIROTATION AND CAP, P/N 4810



Finish: Matte (L41 & L42).

- L42** PLASTIC LEVER HANDLE WITH ANTIROTATION AND CAP, P/N 4811



- L3** PLASTIC .940" HIGH



| OPTION CODE | PLASTIC ACTUATOR COLORS |
|-------------|--------------------------------|
| NONE | No Actuator Color (L40 option) |
| 2 | BLACK |
| 3 | RED |

* Add .070 (1,78) for D, D8 & D9 bushings, subtract .020 (0,51) for H3 bushing.

NOTE: Lever handle for L41 & L42 actuators supplied, but not installed. For interchangeability, order L40 actuator option and lever handles separately, see page F-16. L4X actuators not available with H4, Y1, Y4 bushings. Antirotation: Provides anti-'push-in' feature on actuator.



Dimensions are shown: Inches (mm)
Specifications and dimensions subject to change



F

Toggle

7000 Series Miniature Toggle Switches

BUSHING

Y .350" HIGH, THREADED, KEYWAY
Y9 .350" HIGH, UNTHREADED, KEYWAY



NONE NO BUSHING
No bushing choice required with KXX, TXX actuators. (exception: Specify CW if splashproof bushing desired).

D .280" HIGH, THREADED, KEYWAY
D8 .280" HIGH, UNTHREADED, FLAT³
D9 .280" HIGH, UNTHREADED, KEYWAY



H .296" HIGH, FLAT THREADED, HIGH TORQUE^{1,2}



H3 .315" HIGH, KEYWAY THREADED, HIGH TORQUE^{1,2}



Y bushing standard with C, W-W5, Z or Z3 terminations.

D9 bushing standard with all terminations except C, W-W5, Z or Z3. Add .070 (1, 78) to all actuators lengths with D, D8 & D9 bushings.

Subtract .020 (0, 51) from all actuator lengths for H3 bushing.

H4 8mm HIGH, KEYWAY, THREADED, METRIC HIGH TORQUE^{1,2,3}



Y1 .378" HIGH, KEYWAY, THREADED, HIGH TORQUE^{1,2,4}



Y3 8.9mm HIGH, KEYWAY, THREADED, METRIC



Y4 .378" HIGH, FLAT, THREADED, HIGH TORQUE^{1,2,5}



CW THREADED, SPLASHPROOF^{1,2}
For T & T1 actuators.



IP67 Degree of protection, totally protected against dust, full-scale voltage protection, temporary immersion. Internal actuator seal standard. External bushing seal available separately from APM Hexseal, part # MFS-60064.

For actuators other than T, T1 and KXX.



IP67 Degree of protection, totally protected against dust, full-scale voltage protection, temporary immersion. Internal actuator seal and external bushing seal washer standard. IP65 degree of protection for LXP, MP, PX or SP with CW option.

| OPTION CODE | BUSHING FINISH |
|-------------|--|
| NONE | NICKEL on all bushings except 'D8' satin chrome. |
| 2 | BLACK |

- Will withstand 12 in.-lbs. of torque with no distortion.
- CW, H, H3, H4, Y1 & Y4 bushings not available on single pole models with A4 terminations.
- D8 & H4 bushings available only with L, L1, L2, M & S actuators.
- Y1 bushing available only with LXP, MP, PX & SP actuators.
- Y4 bushing not available with L4X actuators.

NOTE: Two mounting nuts, locking ring and lockwasher supplied standard with threaded bushings. Black hardware is supplied when either black bushings or actuators are specified. Optional mounting nut and locking ring styles and finishes available, see Section N.

PANEL MOUNTING



Dimensions are shown: Inches (mm)
Specifications and dimensions subject to change

Toggle
F



7000 Series Miniature Toggle Switches

TERMINATIONS

Z SOLDER LUG



SPDT thru 4PDT

Not available with P, R or S contact materials.

C PC THRU-HOLE

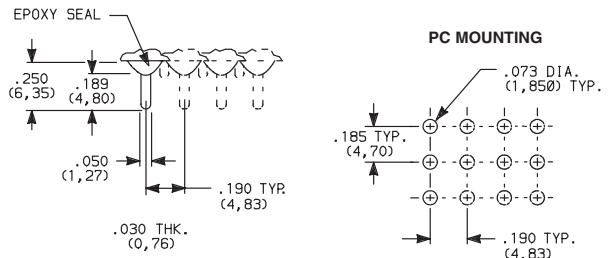

SPDT thru 4PDT

Z3 QUICK CONNECT



SPDT thru 4PDT

Not available with P, R or S contact materials.
Mating quick connector available, order part number 530100000, page F-16.

W, W1, W3, W4, W5 WIRE WRAP



| OPTION CODE | DIM 'A' |
|-------------|---------------|
| W | .750 (19,05) |
| W1 | .964 (24,48) |
| W3 | .425 (10,80) |
| W4 | 1.062 (26,97) |
| W5 | 1.305 (33,15) |

SPDT thru 4PDT

A RIGHT ANGLE, PC THRU-HOLE



7101MD9ABE
Horizontal Actuation
SPDT

SECTION A-A
Terminal Nos.
For Reference Only

Switch support with CW, H, H3, H4, Y1, Y4 bushings and KXX actuators.

Part No. Shown: 7101MHABE

A3 RIGHT ANGLE, SNAP-IN, PC THRU-HOLE

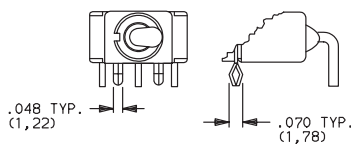

Not available with I seal option.
Terminal bend radii and lead-in manufacturing option.

AW1, AW4 RIGHT ANGLE, EXTENDED, PC THRU-HOLE

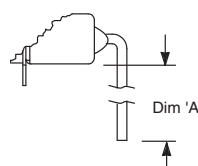

| OPTION CODE | DIM 'A' |
|-------------|------------|
| AW1 | .72 (18,3) |
| AW4 | .83 (21,1) |

PC MOUNTING

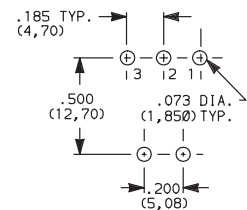

Dimensions are shown: Inches (mm)
Specifications and dimensions subject to change

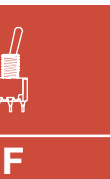

7000 Series Miniature Toggle Switches

TERMINATIONS

A RIGHT ANGLE, PC THRU-HOLE



7201MD9ABE
Horizontal Actuation
DPDT



SECTION A-A

A3 RIGHT ANGLE, SNAP-IN, PC THRU-HOLE

AW1, AW4 RIGHT ANGLE, EXTENDED, PC THRU-HOLE



| OPTION CODE | DIM 'A' |
|-------------|------------|
| AW1 | .40 (10,2) |
| AW4 | .50 (12,7) |

PC MOUNTING



Not available with I seal option.
Terminal bend radii and lead-in manufacturing option.

A RIGHT ANGLE, PC THRU-HOLE



7301MD9ABE
Horizontal Actuation
3PDT

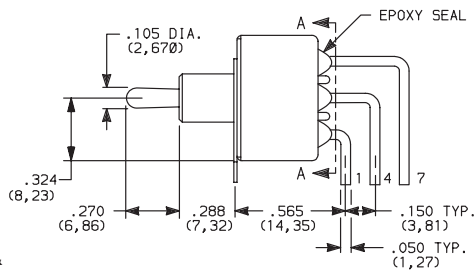

SECTION A-A

AW4 RIGHT ANGLE, EXTENDED, PC THRU-HOLE



PC MOUNTING



Not available with I seal option.
Terminal bend radii and lead-in manufacturing option.



F

Toggle



Dimensions are shown: Inches (mm)
Specifications and dimensions subject to change

7000 Series Miniature Toggle Switches

TERMINATIONS

A2 RIGHT ANGLE, PC THRU-HOLE,
.156" PITCH



Not available with TXX actuators and I seal.
Terminal bend radii and lead-in manufacturing option.



7101MHA2BE
Horizontal Actuation
SPDT

A4 RIGHT ANGLE, PC THRU-HOLE
.156" PITCH

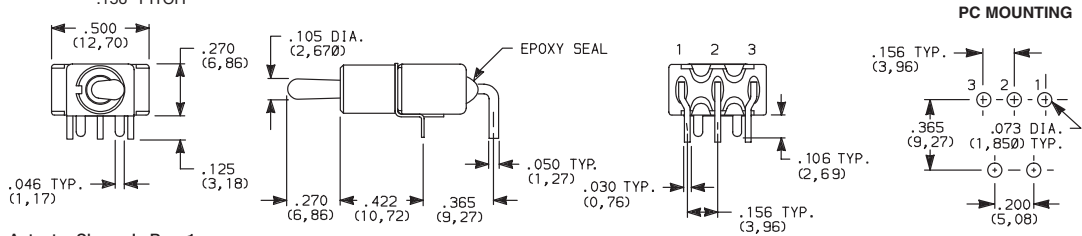

Not available with KXX & TXX actuators, CW, H, H3, H4, Y1 & Y4 bushings, and I seal. Terminal bend radii and lead-in manufacturing option.

NOTE: The A4 option is available with any contact material and can be UL recognized and CSA certified. The PC pattern must clear switch support legs.



7101MD9A4BE
Horizontal Actuation
SPDT

AV2 VERTICAL RIGHT ANGLE, PC THRU-HOLE,
.150" PITCH

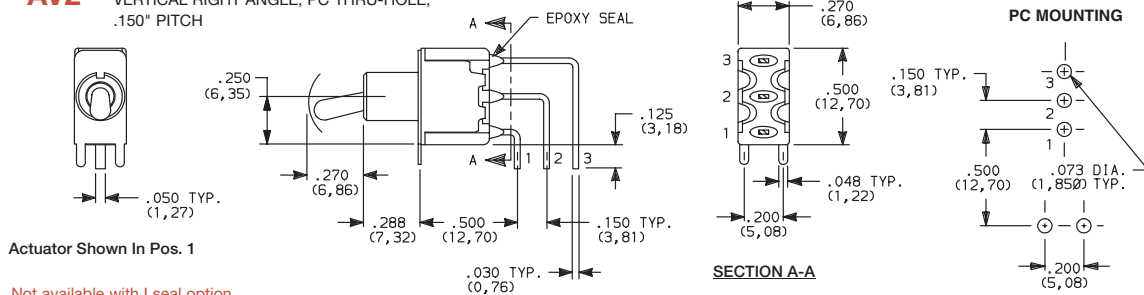

Not available with I seal option.
Terminal bend radii and lead-in manufacturing option.



7101MD9AV2BE
Horizontal Actuation
SPDT

AV2 VERTICAL RIGHT ANGLE, PC THRU-HOLE,
.150" PITCH



Not available with I seal option.
Terminal bend radii and lead-in manufacturing option.



7201MD9AV2BE
Vertical Actuation
DPDT



Dimensions are shown: Inches (mm)
Specifications and dimensions subject to change

www.ck-components.com



7000 Series Miniature Toggle Switches

TERMINATIONS

AV2 VERTICAL RIGHT ANGLE, PC THRU-HOLE,
.150" PITCH



7301MD9AV2BE
Vertical Actuation
3PDT

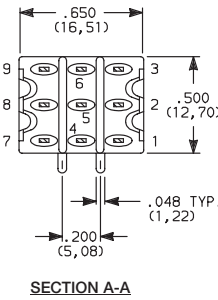

Not available with I seal option.
Terminal bend radii and lead-in manufacturing option.

AV2 VERTICAL RIGHT ANGLE, PC THRU-HOLE,
.150" PITCH



7401MD9AV2BE
Vertical Actuation
4PDT



Not available with I seal option.
Terminal bend radii and lead-in manufacturing option.

V2, V6, V7, V8 VERTICAL MOUNT, V-BRACKET

V21, V71, V81 VERTICAL MOUNT, V-BRACKET, SNAP-IN



7101MD9_BE
SPDT



| OPTION CODE | DIM 'A' |
|----------------|--------------|
| V2, V21 | .555 (14,10) |
| V6 | .460 (11,68) |
| V7, V71 | .630 (16,00) |
| V8, V81 | .953 (24,21) |

Not available with I seal option.



F

Toggle



Dimensions are shown: Inches (mm)
Specifications and dimensions subject to change

7000 Series Miniature Toggle Switches

TERMINATIONS



V2, V6, V7, V8 VERTICAL MOUNT, V-BRACKET

V21, V61, V71, V81 VERTICAL MOUNT, V-BRACKET, SNAP-IN

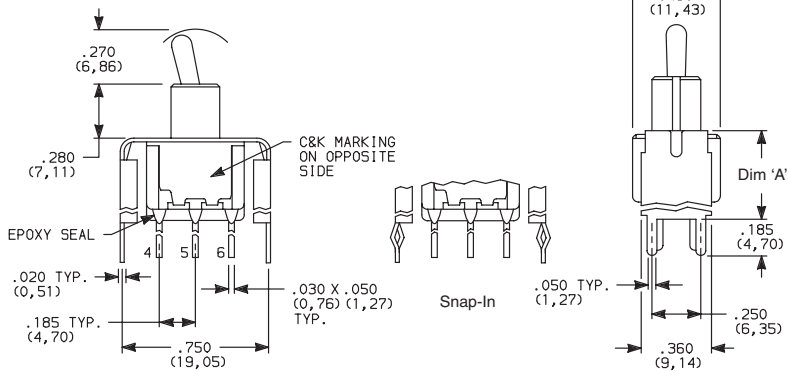

Actuator Shown In Pos. 1

Not available with I seal option.

PC MOUNTING

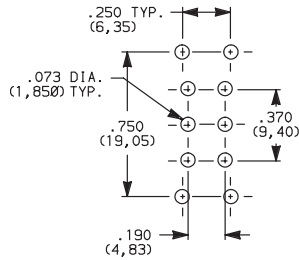

| OPTION CODE | DIM 'A' |
|----------------|--------------|
| V2, V21 | .555 (14,10) |
| V6, V61 | .460 (11,68) |
| V7, V71 | .630 (16,00) |
| V8, V81 | .953 (24,21) |



7201MD9_BE
DPDT

V2, V7, V8 VERTICAL MOUNT, V-BRACKET

V21, V71, V81 VERTICAL MOUNT, V-BRACKET, SNAP-IN

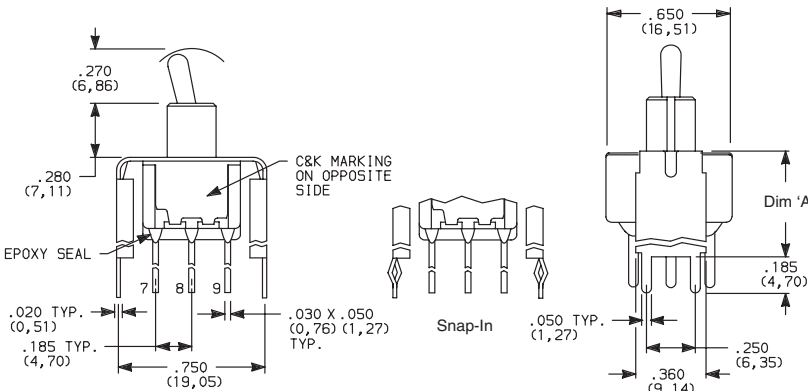

Actuator Shown In Pos. 1

Not available with I seal option.

PC MOUNTING

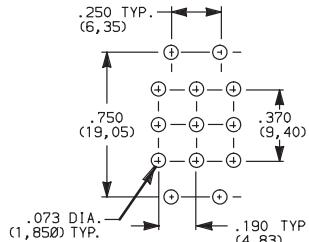

| OPTION CODE | DIM 'A' |
|----------------|--------------|
| V2, V21 | .555 (14,10) |
| V7, V71 | .630 (16,00) |
| V8, V81 | .953 (24,21) |



7301MD9_BE
3PDT

V2, V7, V8 VERTICAL MOUNT, V-BRACKET

V21, V71, V81 VERTICAL MOUNT, V-BRACKET, SNAP-IN

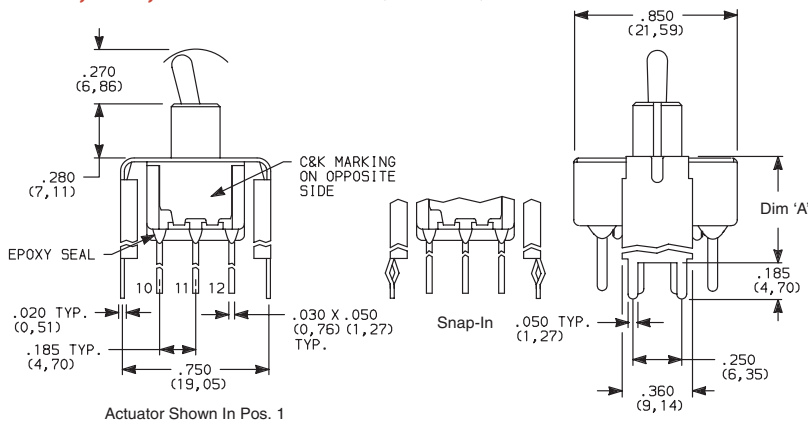

Actuator Shown In Pos. 1

Not available with I seal option.

PC MOUNTING



| OPTION CODE | DIM 'A' |
|----------------|--------------|
| V2, V21 | .555 (14,10) |
| V7, V71 | .630 (16,00) |
| V8, V81 | .953 (24,21) |



7401MD9_BE
4PDT



Third Angle
Projection

Dimensions are shown: Inches (mm)
Specifications and dimensions subject to change



Toggle

7000 Series Miniature Toggle Switches

TERMINATIONS

V3, V4, V9 VERTICAL MOUNT, V-BRACKET

V31, V41 VERTICAL MOUNT, V-BRACKET, SNAP-IN



7101MD9_BE
SPDT

PC MOUNTING

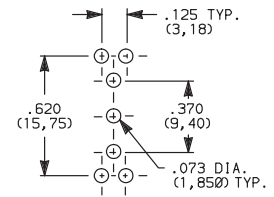

| OPTION CODE | DIM 'A' |
|----------------|---------------|
| V3, V31 | .460 (11,68) |
| V4, V41 | .630 (16,00) |
| V9 | 1.150 (29,21) |

Not available with I seal option.

V3, V4, V9 VERTICAL MOUNT, V-BRACKET

V31, V41 VERTICAL MOUNT, V-BRACKET, SNAP-IN



Actuator Shown In Pos. 1

PC MOUNTING

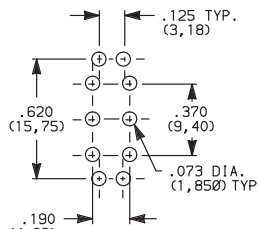

7201MD9_BE
DPDT

| OPTION CODE | DIM 'A' |
|----------------|---------------|
| V3, V31 | .460 (11,68) |
| V4, V41 | .630 (16,00) |
| V9 | 1.150 (29,21) |

Not available with I seal option.

V4, V9 VERTICAL MOUNT, V-BRACKET

V41 VERTICAL MOUNT, V-BRACKET, SNAP-IN

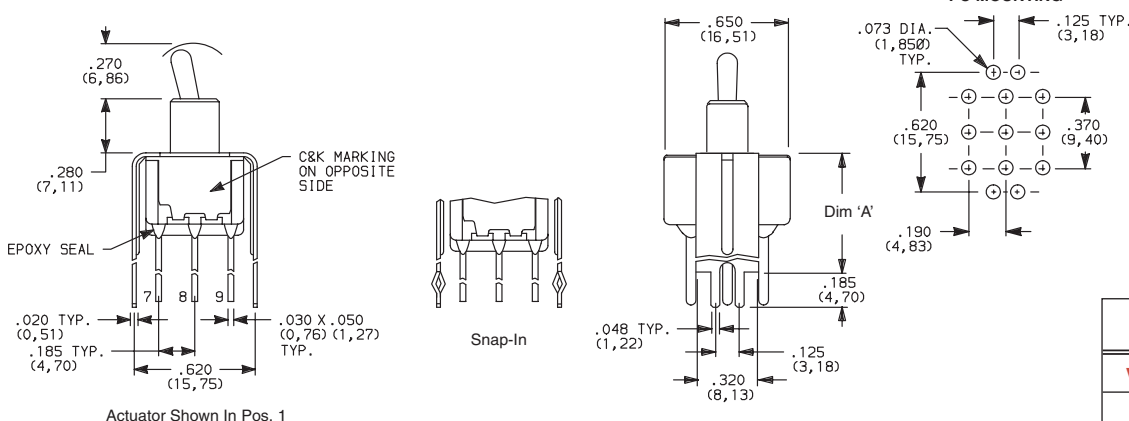

Actuator Shown In Pos. 1

PC MOUNTING

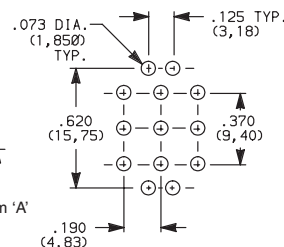

7301MD9_BE
3PDT

| OPTION CODE | DIM 'A' |
|----------------|---------------|
| V4, V41 | .630 (16,00) |
| V9 | 1.150 (29,21) |

Not available with I seal option.



Dimensions are shown: Inches (mm)
Specifications and dimensions subject to change

7000 Series Miniature Toggle Switches

TERMINATIONS

V4, V9 VERTICAL MOUNT, V-BRACKET

V41 VERTICAL MOUNT, V-BRACKET, SNAP-IN



Actuator Shown In Pos. 1

Not available with I seal option.

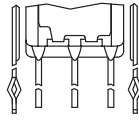

Snap-In

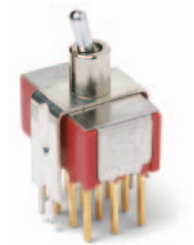
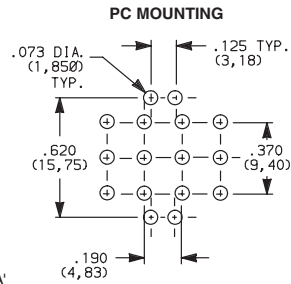
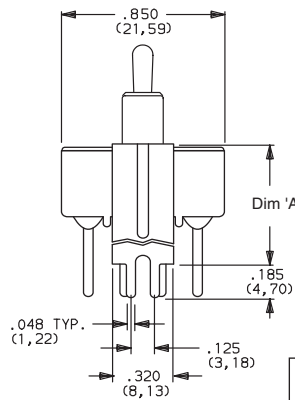

7401MD9_BE
4PDT

| OPTION CODE | DIM 'A' |
|----------------|---------------|
| V4, V41 | .630 (16,00) |
| V9 | 1.150 (29,21) |

CONTACT MATERIAL

| OPTION CODE | CONTACT MATERIAL | TERMINAL PLATING | RATINGS | |
|-------------|------------------------------------|------------------------|-----------------------------------|--|
| | | | | |
| B | GOLD ¹ | GOLD ¹ | LOW LEVEL/ DRY CIRCUIT | 0.4 VA MAX. @ 20 V AC OR DC MAX. |
| P | | MATTE-TIN ⁶ | | |
| Q | SILVER ^{4,5} | SILVER ⁵ | POWER | 5 AMPS @ 120 V AC OR 28 V DC; 2 AMPS @ 250 V AC. |
| S | | MATTE-TIN ⁶ | | |
| G | GOLD OVER SILVER ^{2,3} | GOLD ³ | LOW LEVEL/DRY CIRCUIT OR POWER | 0.4 VA MAX @ 20 V AC OR DC MAX. OR 5 AMPS @ 120 V AC OR 28 V DC; 2 AMPS @ 250 V AC. |
| R | | MATTE-TIN ⁶ | | |

* Note: See Technical Data section of this catalog for RoHS compliant and compatible definitions and specifications.

¹ CONTACTS & TERMINALS: Copper alloy, with gold plate over nickel plate.

² END CONTACTS: Coin silver, with gold plate over nickel plate.

³ CENTER CONTACTS & ALL TERMINALS: Copper alloy, with gold plate over nickel plate.

⁴ END CONTACTS: Coin silver, silver plated.

⁵ CENTER CONTACT & ALL TERMINALS: Copper alloy, silver plated.

⁶ TERMINALS: Copper alloy, with matte tin alloy nickel plate.

NOTE: Any models supplied with P, S, R, Q, B or G contact material are RoHS compliant.

U11-U415 model numbers  with all options when ordered with G, S, R, or Q contact material.

B contact material standard with all terminations except C, Z & Z3.

Q contact material standard with C, Z & Z3 terminations.

P, S & R contact materials not available with Z & Z3 terminations.

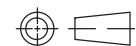

Third Angle
Projection

Dimensions are shown: Inches (mm)
Specifications and dimensions subject to change



F

Toggle

