

# 7000 Series Miniature Toggle Switches

## Features/Benefits

- Multi-pole and multi-position
- Wide variety of actuator and termination options
- Epoxy terminal-seal compatible with bottom wash cleaning
- RoHS complaint models available

## Typical Applications

- Telecommunications
- Instrumentation
- Medical equipment



## Specifications

CONTACT RATING: B contact material: 0.4 VA max. @ 20 V AC or DC max. Q contact material: 5 AMPS @ 120 V AC or 28 V DC; 2 AMPS @ 250 V AC. See page F-15 for additional ratings.

ELECTRICAL LIFE: 7X01 and UX1 models: 100,000 make-and-break cycles at full load. All other models: 40,000 cycles.

CONTACT RESISTANCE: Below 10 m Ω typ. initial @ 2-4 V DC, 100 mA, for both silver and gold plated contacts.

INSULATION RESISTANCE: 10<sup>9</sup> Ω min.

DIELECTRIC STRENGTH: 1000 Vrms min. @ sea level.

OPERATING TEMPERATURE: -30°C to 85°C.

SOLDERABILITY: Per MIL-STD-202F method 208D, or EIA RS-186E method 9 (1 hour steam aging).

For materials see page F-4.

**NOTE:** Any models supplied with P, S, R, Q, B or G contact material are RoHS compliant and compatible.

**NOTE:** Specifications listed above are for switches with standard options. For information on specific and custom switches, consult Customer Service Center.

## Build-A-Switch

To order, simply select desired option from each category and place in the appropriate box. Available options are shown and described on pages F-4 thru F-16. For additional options not shown in catalog, consult our Customer Service Center.

|  |  |   |  |
|--|--|---|--|
| <p><b>Switch Function</b></p> <p><b>7101</b> SP On-None-On<br/> <b>7103</b> SP On-Off-On<br/> <b>7105</b> SP Mom.-Off-Mom.<br/> <b>7107</b> SP On-Off-Mom.<br/> <b>7108</b> SP On-None-Mom.<br/> <b>7109</b> SP None-On-Mom.<br/> <b>7201</b> DP On-None-On<br/> <b>7203</b> DP On-Off-On<br/> <b>7205</b> DP Mom.-Off-Mom.<br/> <b>7207</b> DP On-Off-Mom.<br/> <b>7208</b> DP On-None-Mom.<br/> <b>7211</b> DP On-On-On<br/> <b>7213</b> DP On-On-Mom.<br/> <b>7215</b> DP Mom.-On-Mom.<br/> <b>7301</b> 3P On-None-On<br/> <b>7303</b> 3P On-Off-On<br/> <b>7305</b> 3P Mom.-Off-Mom.<br/> <b>7308</b> 3P On-None-Mom.<br/> <b>7401</b> 4P On-None-On<br/> <b>7403</b> 4P On-Off-On<br/> <b>7405</b> 4P Mom.-Off-Mom.<br/> <b>7408</b> 4P On-None-Mom.<br/> <b>7411</b> 4P On-On-On<br/> <b>7413</b> 4P On-On-Mom.<br/> <b>7415</b> 4P Mom.-On-Mom.</p> <p><small>Note: UL models available, see pages F-4 &amp; F-5.</small></p> | <p><b>Actuator</b></p> <p><b>M</b> .200" high<br/> <b>P3</b> Flatted, anti-rotation, .450" high<br/> <b>S</b> .420" high<br/> <b>T</b> .687" high, 15/32 bushing<br/> <b>K2</b> Locking lever, .704" high<br/> <b>K9</b> Locking lever, .704" high<br/> <b>K12</b> Locking lever, .732" high<br/> <b>K19</b> Locking lever, .732" high<br/> <b>L</b> .840" high<br/> <b>L1</b> .640" high<br/> <b>L1P</b> Anti-rotation, .640" high<br/> <b>L2</b> .550" high<br/> <b>L2P</b> Anti-rotation, .550" high<br/> <b>L3</b> Plastic .940" inch<br/> <b>L40</b> Lever handle without cap<br/> <b>L41</b> .531" high lever handle with cap<br/> <b>L42</b> .838" high lever handle with cap<br/> <b>MP</b> Anti-rotation, .200" high<br/> <b>P1</b> Flatted, anti-rotation, .840" high<br/> <b>P4</b> Flatted, anti-rotation, .250" high<br/> <b>SP</b> Anti-rotation, .420" high<br/> <b>T1</b> .487" high, 15/32 bushing<br/> <b>T1P</b> Anti-rotation, .487" high, 15/32 bushing<br/> <b>T2P</b> Flatted, anti-rotation, .610" high, 15/32 bushing<br/> <b>TP</b> Anti-rotation, .687" high, 15/32 bushing</p> | <p><b>Bushing</b></p> <p><b>D</b> .280 high, keyway<br/> <b>H</b> .296 high, flat<br/> <b>Y</b> .350 high, keyway<br/> <b>NONE</b> No bushing choice required<br/> <b>CW</b> Splashproof<br/> <b>D8</b> .280" high, flat<br/> <b>D9</b> .280" high, keyway<br/> <b>H3</b> .315" high, keyway<br/> <b>H4</b> 8mm high, keyway<br/> <b>Y1</b> .378" high, keyway<br/> <b>Y3</b> 8.9mm high, keyway<br/> <b>Y4</b> .378" high, flat<br/> <b>Y9</b> .350" high, keyway</p> <p><b>Terminations</b></p> <p><b>A</b> Right angle, PC thru-hole<br/> <b>AV2</b> Vert. right angle, PC thru-hole<br/> <b>C</b> PC Thru-hole<br/> <b>V3</b> .460 high, V-bracket<br/> <b>Z</b> Solder lug<br/> <b>A2</b> Right angle, PC thru-hole<br/> <b>A3</b> Right angle, PC thru-hole<br/> <b>A4</b> Right angle, PC thru-hole<br/> <b>AW1</b> Right angle, extended, PC thru-hole<br/> <b>AW4</b> Right angle, extended, PC thru-hole<br/> <b>V2</b> .555" high, V-bracket<br/> <b>V4</b> .630" high, V-bracket<br/> <b>V6</b> .460" high, V-bracket<br/> <b>V7</b> .630" high, V-bracket<br/> <b>V8</b> .953" high, V-bracket<br/> <b>V9</b> 1.150" high, V-bracket<br/> <b>V21</b> .555" high, snap-in V-bracket<br/> <b>V31</b> .460" high, snap-in V-bracket<br/> <b>V41</b> .630" high, snap-in V-bracket<br/> <b>V71</b> .630" high, snap-in V-bracket<br/> <b>V81</b> .953" high, snap-in V-bracket</p> | <p><b>Contact Material</b></p> <p><b>B</b> Gold<br/> <b>P</b> Gold, matte-tin<br/> <b>Q</b> Silver<br/> <b>S</b> Silver, matte-tin<br/> <b>G</b> Gold over silver<br/> <b>R</b> Gold over silver, matte-tin</p> <p><b>Seal</b></p> <p><b>E</b> Epoxy<br/> <b>I</b> Epoxy potted base</p> <p><b>Actuator Color/Finish</b></p> <p><b>NONE</b> Bright chrome<br/> <b>2</b> Black<br/> <b>3</b> Red<br/> <b>S</b> Satin chrome</p> <p><b>KXX Actuator Color/Finish</b></p> <p><b>NONE</b> Natural aluminum<br/> <b>2</b> Black anodized aluminum<br/> <b>3</b> Red anodized aluminum<br/> <b>7</b> Blue anodized aluminum</p> <p><b>Bushing Finish</b></p> <p><b>NONE</b> Nickel on all bushings (except D8, satin chrome)<br/> <b>2</b> Black</p> |
|--|--|---|--|



Dimensions are shown: Inches (mm)  
Specifications and dimensions subject to change



Toggle

# 7000 Series Miniature Toggle Switches

## Materials

CASE: Glass filled nylon 6/6, flame retardant, heat stabilized, or diallyl phthalate (DAP) (UL 94V-0).

ACTUATOR: Brass, chrome plated.

BUSHING: Brass or zinc, nickel plated.

HOUSING: Stainless steel.

SWITCH SUPPORT: Brass or steel, tin plated.

END CONTACTS: B contact material: Copper alloy, with gold plate over nickel plate. Q contact material: Coin silver, silver plated. See page F-15 for additional contact materials.

CENTER CONTACTS & ALL TERMINALS: B contact material: Copper alloy, with gold plate over nickel plate. Q contact material: Copper alloy, silver plated. See above for additional contact materials.

TERMINAL SEAL: Epoxy.

HARDWARE: Nut & Locking Ring: Brass, nickel plated.  
Lockwasher: Steel, nickel plated.

**NOTE:** Materials listed above are for switches with standard options. For information on specific and custom switches, consult Customer Service Center.

## SWITCH FUNCTION

| NO. POLES | MODEL NO. | UL** MODEL NO. | SWITCH FUNCTION  |                  |                  | CONNECTED TERMINALS |                  |                  | SCHEMATIC |
|-----------|-----------|----------------|------------------|------------------|------------------|---------------------|------------------|------------------|-----------|
|           |           |                | POS. 1<br>KEYWAY | POS. 2<br>KEYWAY | POS. 3<br>KEYWAY | POS. 1<br>KEYWAY    | POS. 2<br>KEYWAY | POS. 3<br>KEYWAY |           |
| SP        | 7101      | U11            | ON               | NONE             | ON               | 2-3                 | N/A              | 2-1              |           |
|           | 7103      | U13            | ON               | OFF              | ON               | 2-3                 | OPEN             | 2-1              |           |
|           | 7105      | U15            | MOM.             | OFF              | MOM.             |                     |                  |                  |           |
|           | 7107      | U17            | ON               | OFF              | MOM.             |                     |                  |                  |           |
|           | 7108      | U18            | ON               | NONE             | MOM.             | 2-3                 | N/A              | 2-1              |           |
|           | 7109      | U19            | NONE             | ON               | MOM.             | N/A                 | 2-3              | 2-1              |           |

### SPDT



|    |       |       |      |      |      |         |         |         |  |
|----|-------|-------|------|------|------|---------|---------|---------|--|
| DP | 7201  | U21   | ON   | NONE | ON   | 2-3,5-6 | N/A     | 2-1,5-4 |  |
|    | 7203  | U23   | ON   | OFF  | ON   | 2-3,5-6 | OPEN    | 2-1,5-4 |  |
|    | 7205  | U25   | MOM. | OFF  | MOM. |         |         |         |  |
|    | 7207  | U27   | ON   | OFF  | MOM. |         |         |         |  |
|    | 7208  | U28   | ON   | NONE | MOM. | 2-3,5-6 | N/A     | 2-1,5-4 |  |
|    | 7211* | U211* | ON   | ON   | ON   | 2-3,5-6 | 2-3,5-4 | 2-1,5-4 |  |
|    | 7213* | U213* | ON   | ON   | MOM. |         |         |         |  |
|    | 7215* | U215* | MOM. | ON   | MOM. |         |         |         |  |

### DPDT



MOM. = Momentary

\*\* U11-U415 model nos.



with all options when ordered with G, R, Q or S contact material.

\* Wiring for 3-way switch, see Section N.



Third Angle  
Projection

Dimensions are shown: Inches (mm)  
Specifications and dimensions subject to change



# 7000 Series Miniature Toggle Switches

## SWITCH FUNCTION

| NO. POLES | MODEL NO.   | UL** MODEL NO. | SWITCH FUNCTION |        |        | CONNECTED TERMINALS |        |             | SCHEMATIC |
|-----------|-------------|----------------|-----------------|--------|--------|---------------------|--------|-------------|-----------|
|           |             |                | POS. 1          | POS. 2 | POS. 3 | POS. 1              | POS. 2 | POS. 3      |           |
|           |             |                | KEYWAY          | KEYWAY | KEYWAY | KEYWAY              | KEYWAY | KEYWAY      |           |
| 3P        | <b>7301</b> | <b>U31</b>     | ON              | NONE   | ON     | 2-3,5-6,8-9         | N/A    | 2-1,5-4,8-7 |           |
|           | <b>7303</b> | <b>U33</b>     | ON              | OFF    | ON     | 2-3,5-6,8-9         | OPEN   | 2-1,5-4,8-7 |           |
|           | <b>7305</b> | <b>U35</b>     | MOM.            | OFF    | MOM.   |                     |        |             |           |
|           | <b>7307</b> | <b>U37</b>     | ON              | OFF    | MOM.   |                     |        |             |           |
|           | <b>7308</b> | <b>U38</b>     | ON              | NONE   | MOM.   |                     |        |             |           |

### 3PDT



|              |              |              |      |      |                   |                   |                   |                   |  |
|--------------|--------------|--------------|------|------|-------------------|-------------------|-------------------|-------------------|--|
| 4P           | <b>7401</b>  | <b>U41</b>   | ON   | NONE | ON                | 2-3,5-6,8-9,11-12 | N/A               | 2-1,5-4,8-7,11-10 |  |
|              | <b>7403</b>  | <b>U43</b>   | ON   | OFF  | ON                | 2-3,5-6,8-9,11-12 | OPEN              | 2-1,5-4,8-7,11-10 |  |
|              | <b>7405</b>  | <b>U45</b>   | MOM. | OFF  | MOM.              |                   |                   |                   |  |
|              | <b>7408</b>  | <b>U48</b>   | ON   | NONE | MOM.              |                   |                   |                   |  |
|              | <b>7411*</b> | <b>U411*</b> | ON   | ON   | ON                |                   |                   |                   |  |
|              | <b>7413*</b> | <b>U413*</b> | ON   | ON   | MOM.              |                   |                   |                   |  |
| <b>7415*</b> | <b>U415*</b> | MOM.         | ON   | MOM. | 2-3,5-6,8-9,11-12 | 2-3,5-4,8-9,11-10 | 2-1,5-4,8-7,11-10 |                   |  |

### 4PDT



MOM. = Momentary

Wiring for 3-way switch, see Section N.

\*\* U11-U415 model nos. with all options when ordered with G, Q, R or S contact material.



Dimensions are shown: Inches (mm)  
Specifications and dimensions subject to change



Toggle

# 7000 Series Miniature Toggle Switches

## ACTUATOR

**S** .420" HIGH <sup>1</sup>  
**SP** ANTIROTATION, .420" HIGH <sup>2,3</sup>



S actuator standard when ordered with C, W-W5, Z & Z3 terminations. Caps are available separately, see page F-16.

**M** .200" HIGH <sup>1</sup>  
**MP** ANTIROTATION, .200" HIGH <sup>2,3</sup>



M actuator standard when ordered with all terminations except C, W-W5, Z & Z3. Caps are available separately, see page F-16.

**L, L1, L2** .840", .640", .550" HIGH <sup>1</sup>  
**L1P, L2P** ANTIROTATION, .840", .640", .550" HIGH <sup>2,3</sup>



| OPTION CODE | DIM 'A'      |
|-------------|--------------|
| L           | .840 (21,34) |
| L1, L1P     | .640 (16,26) |
| L2, L2P     | .550 (13,97) |

Caps are available separately, see page F-16.

**\*P1** FLATTED WITH ANTIROTATION, .840" HIGH <sup>2,3</sup>



**\*P3** FLATTED WITH ANTIROTATION, .450" HIGH <sup>2,3</sup>



**\*P4** FLATTED WITH ANTIROTATION, .250" HIGH <sup>2,3</sup>



\*Dress nut part number 709901201 supplied standard with threaded bushing. (Part number 709903201 with metric threaded bushings.)

**T** .687 (17,45) HIGH <sup>1,2</sup>  
**TP** ANTIROTATION, .687 (17,45) HIGH, 15/32 BUSHING <sup>1,2,3</sup>



**T1** .487 (12,37) HIGH <sup>1,2</sup>  
**T1P** ANTIROTATION, .487 (12,37) HIGH, 15/32 BUSHING <sup>1,2,3</sup>



**T2P** FLATTED, ANTIROTATION, .610" HIGH, 15/32 BUSHING <sup>1,2,3</sup>



Bushing option code not required unless CW splashproof bushing ordered. TP & T1P actuators not available with CW splashproof bushing. All TXX actuators not available on single pole models with A-A4, AW1-AW4 terminations.

Bushing option code not required. T2P actuator not available with CW splashproof bushing or single pole models with A-A4, AW1-AW4 terminations.



**F**  
Toggle

- <sup>1</sup> L, L1, L2, M, S & TXX actuators not available with Y1 bushing.
- <sup>2</sup> L1P, L2P, MP, P1, P3, P4, SP & TXX actuators not available with D8 & H4 bushing.
- <sup>3</sup> Antirotation: Provides anti-'push-in' feature on actuator.
- \* Add .070 (1,78) for D, D8 & D9 bushings, subtract .020 (0,51) for H3 bushing.

| OPTION CODE | ACTUATOR FINISH                          |
|-------------|--|
| <b>NONE</b> | BRIGHT CHROME-With Nickel Plated Bushing |
| <b>2</b>    | BLACK                                    |
| <b>S</b>    | SATIN CHROME                             |

**NOTE:** Black hardware is supplied when either black actuators or bushings are specified. For additional hardware, see Section N.



Dimensions are shown: Inches (mm)  
Specifications and dimensions subject to change



# 7000 Series Miniature Toggle Switches

## ACTUATOR



- K2** LOCKING LEVER, .704" HIGH (threaded)
- K9** LOCKING LEVER, .704" HIGH (unthreaded)

- K12** LOCKING LEVER, .732" HIGH (threaded)
- K19** LOCKING LEVER, .732" HIGH (unthreaded)



Replaces K, K8

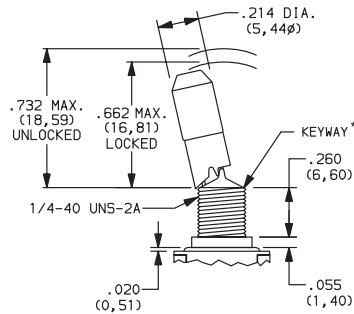

Replaces K1, K18

| OPTION CODE | ACTUATOR CAP FINISH                         |
|-------------|---|
| <b>NONE</b> | NATURAL ALUMINUM—With Nickel Plated Bushing |
| <b>2</b>    | BLACK ANODIZED ALUMINUM                     |
| <b>3</b>    | RED ANODIZED ALUMINUM                       |
| <b>7</b>    | BLUE ANODIZED ALUMINUM                      |

\* All KXX models including KXXCW have a keyway

### Locking Positions



-01 Models  
2 Position lock



-03 & -11 Models  
3 Position lock



-05, -09 & -15 Models  
1 Position lock



-07 & -13 Models  
2 Position lock



-08 Models  
1 Position lock

**NOTE:** To prevent accidental actuation, toggle must be lifted before being actuated. When released, toggle will lock in place. Overtightening mounting nut may cause actuator to bind.

Locking levers supplied with bushing shown.

Bushing option code not required unless CW splashproof bushing ordered.

### L40 LEVER HANDLE WITHOUT CAP



No color choice required

### L41 PLASTIC LEVER HANDLE WITH ANTIROTATION AND CAP, P/N 4810



Finish: Matte (L41 & L42).

### L42 PLASTIC LEVER HANDLE WITH ANTIROTATION AND CAP, P/N 4811



### L3 PLASTIC .940" HIGH



| OPTION CODE | PLASTIC ACTUATOR COLORS        |
|-------------|--------------------------------|
| <b>NONE</b> | No Actuator Color (L40 option) |
| <b>2</b>    | BLACK                          |
| <b>3</b>    | RED                            |

\* Add .070 (1,78) for D, D8 & D9 bushings, subtract .020 (0,51) for H3 bushing.

**NOTE:** Lever handle for L41 & L42 actuators supplied, but not installed. For interchangeability, order L40 actuator option and lever handles separately, see page F-16. L4X actuators not available with H4, Y1, Y4 bushings. Antirotation: Provides anti-'push-in' feature on actuator.



Dimensions are shown: Inches (mm)  
Specifications and dimensions subject to change



F

Toggle

# 7000 Series Miniature Toggle Switches

## BUSHING

**Y** .350" HIGH, THREADED, KEYWAY  
**Y9** .350" HIGH, UNTHREADED, KEYWAY



**NONE** NO BUSHING  
No bushing choice required with KXX, TXX actuators. (exception: Specify CW if splashproof bushing desired).

**D** .280" HIGH, THREADED, KEYWAY  
**D8** .280" HIGH, UNTHREADED, FLAT<sup>3</sup>  
**D9** .280" HIGH, UNTHREADED, KEYWAY



**H** .296" HIGH, FLAT THREADED, HIGH TORQUE<sup>1,2</sup>



**H3** .315" HIGH, KEYWAY THREADED, HIGH TORQUE<sup>1,2</sup>



Y bushing standard with C, W-W5, Z or Z3 terminations.

D9 bushing standard with all terminations except C, W-W5, Z or Z3. Add .070 (1, 78) to all actuators lengths with D, D8 & D9 bushings.

Subtract .020 (0, 51) from all actuator lengths for H3 bushing.

**H4** 8mm HIGH, KEYWAY, THREADED, METRIC HIGH TORQUE<sup>1,2,3</sup>



**Y1** .378" HIGH, KEYWAY, THREADED, HIGH TORQUE<sup>1,2,4</sup>



**Y3** 8.9mm HIGH, KEYWAY, THREADED, METRIC



**Y4** .378" HIGH, FLAT, THREADED, HIGH TORQUE<sup>1,2,5</sup>



**CW** THREADED, SPLASHPROOF<sup>1,2</sup>  
For T & T1 actuators.



IP67 Degree of protection, totally protected against dust, full-scale voltage protection, temporary immersion. Internal actuator seal standard. External bushing seal available separately from APM Hexseal, part # MFS-60064.

For actuators other than T, T1 and KXX.



IP67 Degree of protection, totally protected against dust, full-scale voltage protection, temporary immersion. Internal actuator seal and external bushing seal washer standard. IP65 degree of protection for LXP, MP, PX or SP with CW option.

| OPTION CODE | BUSHING FINISH                                   |
|-------------|--|
| NONE        | NICKEL on all bushings except 'D8' satin chrome. |
| 2           | BLACK  |

- Will withstand 12 in.-lbs. of torque with no distortion.
- CW, H, H3, H4, Y1 & Y4 bushings not available on single pole models with A4 terminations.
- D8 & H4 bushings available only with L, L1, L2, M & S actuators.
- Y1 bushing available only with LXP, MP, PX & SP actuators.
- Y4 bushing not available with L4X actuators.

**NOTE:** Two mounting nuts, locking ring and lockwasher supplied standard with threaded bushings. Black hardware is supplied when either black bushings or actuators are specified. Optional mounting nut and locking ring styles and finishes available, see Section N.

### PANEL MOUNTING



Dimensions are shown: Inches (mm)  
Specifications and dimensions subject to change

Toggle F



# 7000 Series Miniature Toggle Switches

## TERMINATIONS

### Z SOLDER LUG



SPDT thru 4PDT Not available with P, R or S contact materials.

### C PC THRU-HOLE

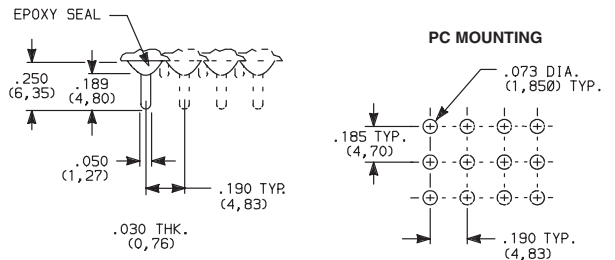

SPDT thru 4PDT

### Z3 QUICK CONNECT

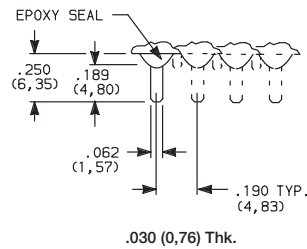

SPDT thru 4PDT Not available with P, R or S contact materials.  
Mating quick connector available, order part number 530100000, page F-16.

### W, W1, W3, W4, W5 WIRE WRAP

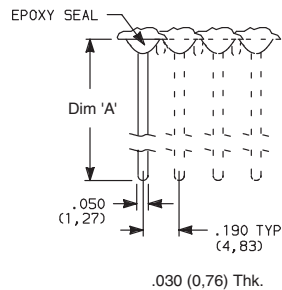

| OPTION CODE | DIM 'A'       |
|-------------|---------------|
| <b>W</b>    | .750 (19,05)  |
| <b>W1</b>   | .964 (24,48)  |
| <b>W3</b>   | .425 (10,80)  |
| <b>W4</b>   | 1.062 (26,97) |
| <b>W5</b>   | 1.305 (33,15) |

SPDT thru 4PDT

### A RIGHT ANGLE, PC THRU-HOLE

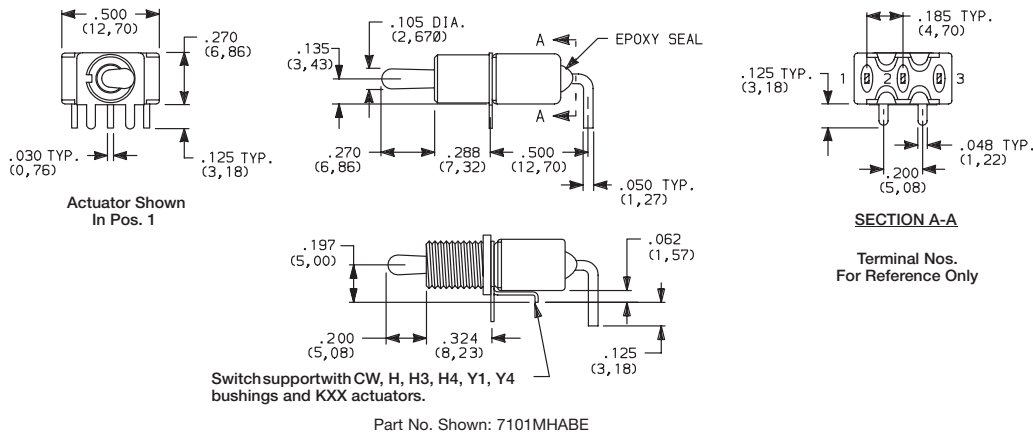

7101MD9ABE  
Horizontal Actuation  
SPDT

### A3 RIGHT ANGLE, SNAP-IN, PC THRU-HOLE

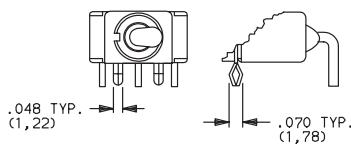

Not available with I seal option.  
Terminal bend radii and lead-in manufacturing option.

### AW1, AW4 RIGHT ANGLE, EXTENDED, PC THRU-HOLE

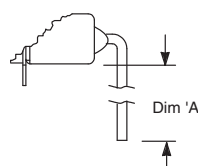

| OPTION CODE | DIM 'A'    |
|-------------|------------|
| <b>AW1</b>  | .72 (18,3) |
| <b>AW4</b>  | .83 (21,1) |

### PC MOUNTING

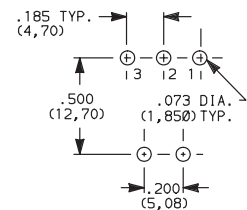

Dimensions are shown: Inches (mm)  
Specifications and dimensions subject to change

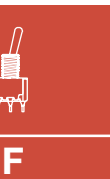

# 7000 Series Miniature Toggle Switches

## TERMINATIONS

**A** RIGHT ANGLE, PC THRU-HOLE



**7201MD9ABE**  
Horizontal Actuation  
**DPDT**



**A3** RIGHT ANGLE, SNAP-IN, PC THRU-HOLE

**AW1, AW4** RIGHT ANGLE, EXTENDED, PC THRU-HOLE



| OPTION CODE | DIM 'A'    |
|-------------|------------|
| <b>AW1</b>  | .40 (10,2) |
| <b>AW4</b>  | .50 (12,7) |

**PC MOUNTING**



Not available with I seal option.  
Terminal bend radii and lead-in manufacturing option.

**A** RIGHT ANGLE, PC THRU-HOLE



**7301MD9ABE**  
Horizontal Actuation  
**3PDT**



**AW4** RIGHT ANGLE, EXTENDED, PC THRU-HOLE



**PC MOUNTING**



Not available with I seal option.  
Terminal bend radii and lead-in manufacturing option.



**F**

**Toggle**



Dimensions are shown: Inches (mm)  
Specifications and dimensions subject to change



# 7000 Series Miniature Toggle Switches

## TERMINATIONS

**A2** RIGHT ANGLE, PC THRU-HOLE,  
.156" PITCH



Not available with TXX actuators and I seal.  
Terminal bend radii and lead-in manufacturing option.



7101MHA2BE  
Horizontal Actuation  
SPDT

**A4** RIGHT ANGLE, PC THRU-HOLE  
.156" PITCH



Not available with KXX & TXX actuators, CW, H, H3, H4, Y1 & Y4 bushings, and I seal. Terminal bend radii and lead-in manufacturing option.

**NOTE:** The A4 option is available with any contact material and can be UL recognized and CSA certified. The PC pattern must clear switch support legs.



7101MD9A4BE  
Horizontal Actuation  
SPDT

**AV2** VERTICAL RIGHT ANGLE, PC THRU-HOLE,  
.150" PITCH

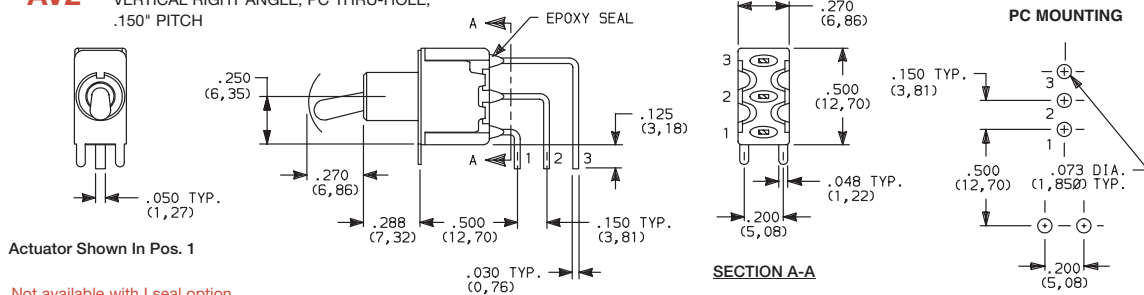

Not available with I seal option.  
Terminal bend radii and lead-in manufacturing option.



7101MD9AV2BE  
Horizontal Actuation  
SPDT

**AV2** VERTICAL RIGHT ANGLE, PC THRU-HOLE,  
.150" PITCH



Not available with I seal option.  
Terminal bend radii and lead-in manufacturing option.



7201MD9AV2BE  
Vertical Actuation  
DPDT



Dimensions are shown: Inches (mm)  
Specifications and dimensions subject to change

www.ck-components.com

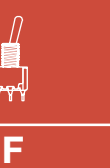

F

Toggle

# 7000 Series Miniature Toggle Switches

## TERMINATIONS

**AV2** VERTICAL RIGHT ANGLE, PC THRU-HOLE,  
.150" PITCH



**7301MD9AV2BE**  
Vertical Actuation  
**3PDT**



Not available with I seal option.  
Terminal bend radii and lead-in manufacturing option.

**AV2** VERTICAL RIGHT ANGLE, PC THRU-HOLE,  
.150" PITCH



**7401MD9AV2BE**  
Vertical Actuation  
**4PDT**



Not available with I seal option.  
Terminal bend radii and lead-in manufacturing option.

**V2, V6, V7, V8** VERTICAL MOUNT, V-BRACKET

**V21, V71, V81** VERTICAL MOUNT, V-BRACKET, SNAP-IN



**7101MD9\_BE**  
**SPDT**



| OPTION CODE    | DIM 'A'      |
|----------------|--------------|
| <b>V2, V21</b> | .555 (14,10) |
| <b>V6</b>      | .460 (11,68) |
| <b>V7, V71</b> | .630 (16,00) |
| <b>V8, V81</b> | .953 (24,21) |

Not available with I seal option.



**F**

**Toggle**



Dimensions are shown: Inches (mm)  
Specifications and dimensions subject to change

# 7000 Series Miniature Toggle Switches

## TERMINATIONS



**V2, V6, V7, V8** VERTICAL MOUNT, V-BRACKET

**V21, V61, V71, V81** VERTICAL MOUNT, V-BRACKET, SNAP-IN



PC MOUNTING



| OPTION CODE    | DIM 'A'      |
|----------------|--------------|
| <b>V2, V21</b> | .555 (14,10) |
| <b>V6, V61</b> | .460 (11,68) |
| <b>V7, V71</b> | .630 (16,00) |
| <b>V8, V81</b> | .953 (24,21) |



7201MD9\_BE  
DPDT

**V2, V7, V8** VERTICAL MOUNT, V-BRACKET

**V21, V71, V81** VERTICAL MOUNT, V-BRACKET, SNAP-IN



PC MOUNTING



| OPTION CODE    | DIM 'A'      |
|----------------|--------------|
| <b>V2, V21</b> | .555 (14,10) |
| <b>V7, V71</b> | .630 (16,00) |
| <b>V8, V81</b> | .953 (24,21) |



7301MD9\_BE  
3PDT

**V2, V7, V8** VERTICAL MOUNT, V-BRACKET

**V21, V71, V81** VERTICAL MOUNT, V-BRACKET, SNAP-IN



PC MOUNTING



| OPTION CODE    | DIM 'A'      |
|----------------|--------------|
| <b>V2, V21</b> | .555 (14,10) |
| <b>V7, V71</b> | .630 (16,00) |
| <b>V8, V81</b> | .953 (24,21) |



7401MD9\_BE  
4PDT

Not available with I seal option.



Dimensions are shown: Inches (mm)  
Specifications and dimensions subject to change



# 7000 Series Miniature Toggle Switches

## TERMINATIONS

**V3, V4, V9** VERTICAL MOUNT, V-BRACKET

**V31, V41** VERTICAL MOUNT, V-BRACKET, SNAP-IN



PC MOUNTING



| OPTION CODE | DIM 'A'       |
|-------------|---------------|
| V3, V31     | .460 (11,68)  |
| V4, V41     | .630 (16,00)  |
| V9          | 1.150 (29,21) |

Not available with I seal option.

**V3, V4, V9** VERTICAL MOUNT, V-BRACKET

**V31, V41** VERTICAL MOUNT, V-BRACKET, SNAP-IN



7201MD9\_BE  
DPDT

| OPTION CODE | DIM 'A'       |
|-------------|---------------|
| V3, V31     | .460 (11,68)  |
| V4, V41     | .630 (16,00)  |
| V9          | 1.150 (29,21) |

Not available with I seal option.

**V4, V9** VERTICAL MOUNT, V-BRACKET

**V41** VERTICAL MOUNT, V-BRACKET, SNAP-IN



7301MD9\_BE  
3PDT

| OPTION CODE | DIM 'A'       |
|-------------|---------------|
| V4, V41     | .630 (16,00)  |
| V9          | 1.150 (29,21) |

Not available with I seal option.



Dimensions are shown: Inches (mm)  
Specifications and dimensions subject to change

www.ck-components.com



F

Toggle



# 7000 Series Miniature Toggle Switches

## TERMINATIONS

**V4, V9** VERTICAL MOUNT, V-BRACKET

**V41** VERTICAL MOUNT, V-BRACKET, SNAP-IN



Actuator Shown In Pos. 1

Not available with I seal option.



7401MD9\_BE  
4PDT

| OPTION CODE    | DIM 'A'       |
|----------------|---------------|
| <b>V4, V41</b> | .630 (16,00)  |
| <b>V9</b>      | 1.150 (29,21) |

## CONTACT MATERIAL

| OPTION CODE | CONTACT MATERIAL                   | TERMINAL PLATING       | RATINGS                           |  |
|-------------|------------------------------------|------------------------|-----------------------------------|--|
|             |                                    |                        |                                   |  |
| <b>B</b>    | GOLD <sup>1</sup>                  | GOLD <sup>1</sup>      | LOW LEVEL/<br>DRY CIRCUIT         | 0.4 VA MAX. @ 20 V AC OR DC MAX.   |
| <b>P</b>    |                                    | MATTE-TIN <sup>6</sup> |                                   |  |
| <b>Q</b>    | SILVER <sup>4,5</sup>              | SILVER <sup>5</sup>    | POWER                             | 5 AMPS @ 120 V AC OR 28 V DC; 2 AMPS @ 250 V AC.                                       |
| <b>S</b>    |                                    | MATTE-TIN <sup>6</sup> |                                   |  |
| <b>G</b>    | GOLD OVER<br>SILVER <sup>2,3</sup> | GOLD <sup>3</sup>      | LOW LEVEL/DRY<br>CIRCUIT OR POWER | 0.4 VA MAX @ 20 V AC OR DC MAX. OR 5 AMPS @ 120 V AC<br>OR 28 V DC; 2 AMPS @ 250 V AC. |
| <b>R</b>    |                                    | MATTE-TIN <sup>6</sup> |                                   |  |

\* Note: See Technical Data section of this catalog for RoHS compliant and compatible definitions and specifications.

<sup>1</sup> CONTACTS & TERMINALS: Copper alloy, with gold plate over nickel plate.

<sup>2</sup> END CONTACTS: Coin silver, with gold plate over nickel plate.

<sup>3</sup> CENTER CONTACTS & ALL TERMINALS: Copper alloy, with gold plate over nickel plate.

<sup>4</sup> END CONTACTS: Coin silver, silver plated.

<sup>5</sup> CENTER CONTACT & ALL TERMINALS: Copper alloy, silver plated.

<sup>6</sup> TERMINALS: Copper alloy, with matte tin alloy nickel plate.

**NOTE:** Any models supplied with P, S, R, Q, B or G contact material are RoHS compliant.

U11-U415 model numbers  with all options when ordered with G, S, R, or Q contact material.

B contact material standard with all terminations except C, Z & Z3.

Q contact material standard with C, Z & Z3 terminations.

P, S & R contact materials not available with Z & Z3 terminations.



Third Angle  
Projection

Dimensions are shown: Inches (mm)  
Specifications and dimensions subject to change



F

Toggle

# 7000 Series Miniature Toggle Switches

## SEAL

### E EPOXY SEAL

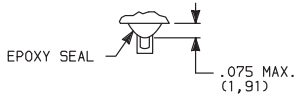

Compatible with "bottom-wash" PC board cleaning methods.

### I EPOXY POTTED BASE

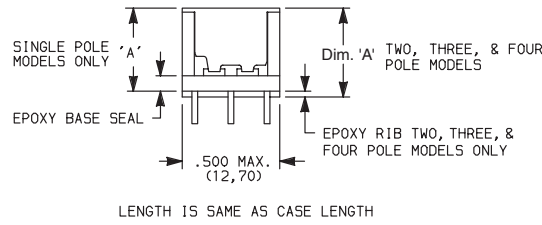

| NO. POLES | DIM 'A'      |
|-----------|--------------|
| SP        | .410 (10,41) |
| DP        | .440 (11,18) |
| 3P        | .505 (12,83) |
| 4P        | .505 (12,83) |

Available with C, W-W5, Z & Z3 terminations only.

## AVAILABLE HARDWARE

### Cap



**PART NO.**  
**896801000** WHITE  
**896802000** BLACK  
**896803000** RED

Material: Polyethylene  
 Finish: Matte

### Cap



**PART NO.**  
**763701000** WHITE  
**763702000** BLACK  
**763703000** RED

Material: Vinyl  
 Finish: Matte

### Cap



**PART NO.**  
**706201000** WHITE  
**706202000** BLACK  
**706203000** RED

Material: Vinyl  
 Finish: Matte

### L41 Lever handle



**PART NO.**  
**481001000** WHITE  
**481002263** BLACK  
**481003000** RED

Material: Nylon  
 Finish: Matte

### L42 Lever handle

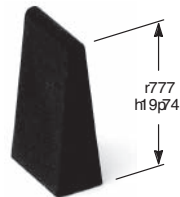

**PART NO.**  
**481101000** WHITE  
**481102263** BLACK  
**481103000** RED

Material: Nylon  
 Finish: Matte

### Fits Z3 Termination female connector



**PART NO.**  
**530100000**

Available in loose pieces.

**NOTE:** Additional nuts, locking rings and lockwashers available separately, see Section N.

Other colors available, consult Customer Service Center.

### 759D02000 Sealing Boot

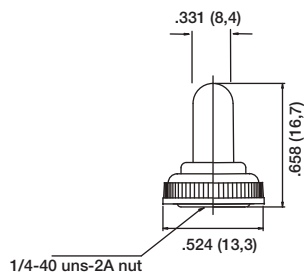

**NOTE:** For use with S actuator style when combined with D, H, H3, Y, and Y4 bushings

### 703D02000 Sealing Boot

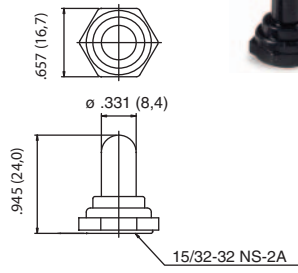

**NOTE:** For use with T and TP style actuators. **Can not be used for Switch Functions: 7103, 7203, 7303, 7403, 7107, 7207, 7307, 7407.**

### 704D02000 Sealing Boot

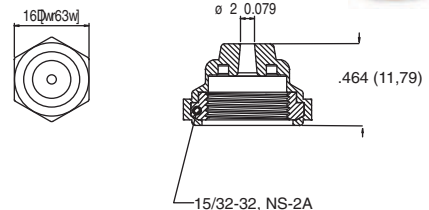

**NOTE:** For use with T, TP and T2P style actuators. Can not be used for Switch Functions: 7103, 7203, 7303, 7403, 7107, 7207, 7307, and 7407.



Dimensions are shown: Inches (mm)  
 Specifications and dimensions subject to change