

C Series Power Rocker Switches



Features/Benefits

- Positive detent
- Attractive design
- Snap-in mounting

Typical Applications

- Floor care products
- Power outlet strips
- Small appliances
- RoHS compliant



Specifications

CONTACT RATING: All Models: 15 AMPS @ 125 V AC; 10 AMPS @ 250 V AC. . Models also available with see rating section.

ELECTRICAL LIFE: 10,000 make-and-break cycles at full load.

INSULATION RESISTANCE: $10^9 \Omega$ min.

DIELECTRIC STRENGTH: 2,500 Vrms min. @ sea level.

NOTE: Specifications and materials listed above are for switches with standard options. For information on specific and custom switches, consult Customer Service center.

Materials

HOUSING & ACTUATOR: 6/6 nylon (UL 94V-2), black (standard).

MOVABLE CONTACTS: Copper, silver plated.

STATIONARY CONTACT & TERMINALS:

C121, C122 models with 'QA' rating: Copper, silver plated.

C221, C222 models with 'QA' rating: Copper.

All models with 'QF' rating: Copper, silver plated.

CONTACT SPRING: Music wire or stainless steel.

OPERATING TEMPERATURE: -30°C to +65°C

Build-A-Switch

To order, simply select desired option from each category and place in the appropriate box. Available options are shown and described on pages G-103 and G-104. For additional options not shown in catalog, consult Customer Service Center.

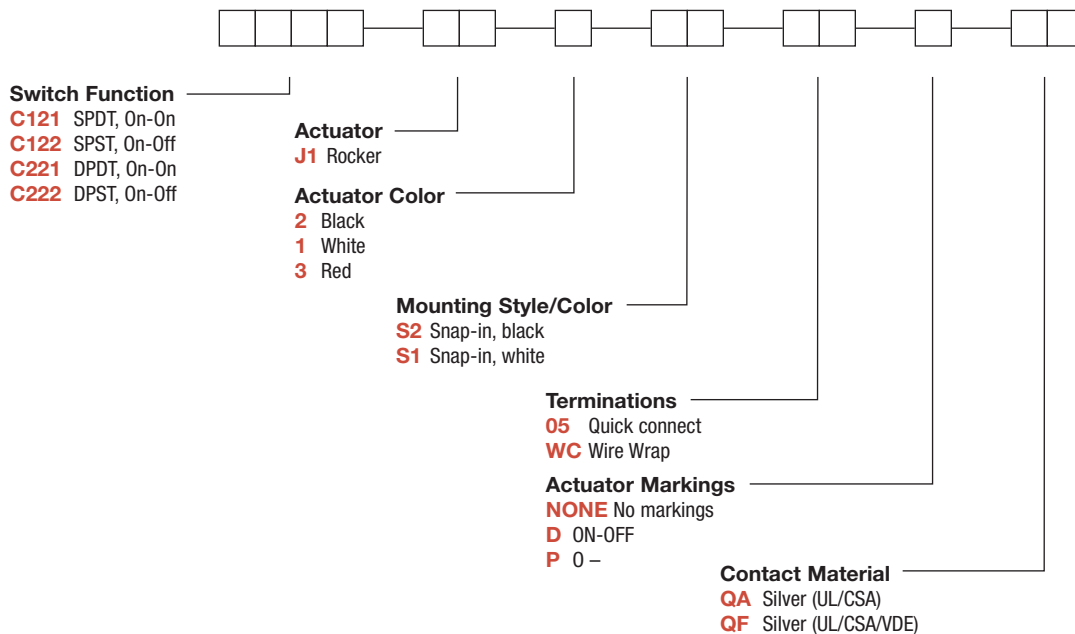

Rocker



G

C&K

Dimensions are shown: Inches (mm)
Specifications and dimensions subject to change

C Series Power Rocker Switches

SWITCH FUNCTION



NO. POLES	MODEL NO.	SWITCH FUNCTION		CONNECTED TERMINALS		SCHEMATIC	
		POS. 1	POS. 2	POS. 1	POS. 2		
SP	C121	ON	ON	2-1 1-1A	2-3 1-1B		
	C122	ON	OFF	2-1 1-1A	OPEN		
DP	C221	ON	ON	1-1A, 2-2A	1-1B, 2-2B		
	C222	ON	OFF	1-1A, 2-2A	OPEN		

SPDT

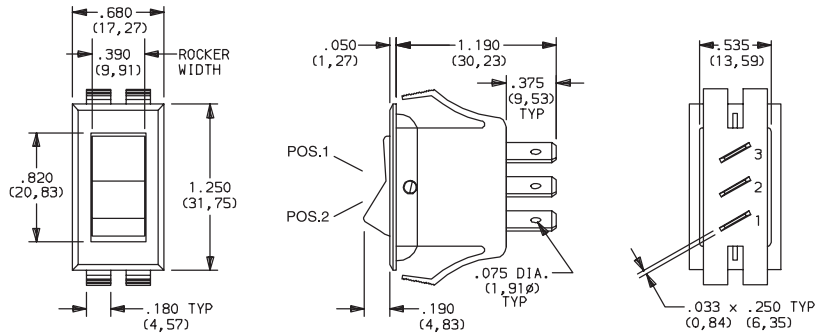

Part number shown: C121J12S205QF

All models with all options.

Only models with 'QF' rating meet international dimensional and electrical requirements .

Contacts make on side opposite actuator thrown.

ACTUATOR

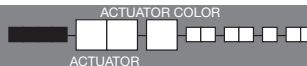

J1

ROCKER

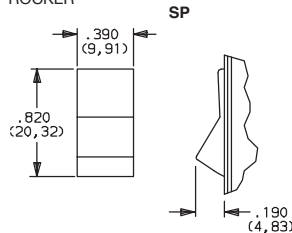

DP

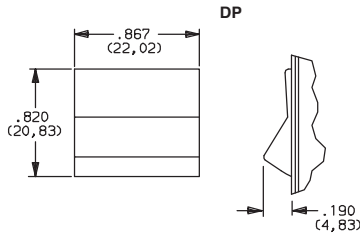

OPTION CODE	ACTUATOR COLOR
2	BLACK
1	WHITE
3	RED

NOTE: Actuator finish: gloss (standard). Other colors available, consult Customer Service Center.

MOUNTING STYLE/COLOR



S1, S2

SNAP-IN

OPTION CODE	HOUSING COLOR
S2	BLACK
S1	WHITE

NOTE: Frame finish on housing: gloss (standard). Other colors available, consult Customer Service Center.

SP

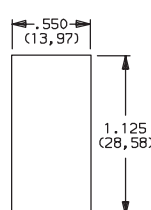

PANEL MOUNTING

DP

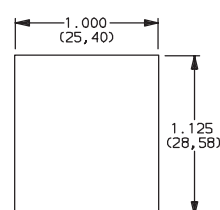

PANEL THICKNESS:
.020 (0,51) TO .200 (5,08)



Dimensions are shown: Inches (mm)

Specifications and dimensions subject to change



C Series Power Rocker Switches

TERMINATIONS

05 QUICK CONNECT

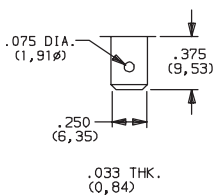

WC WIRE WRAP

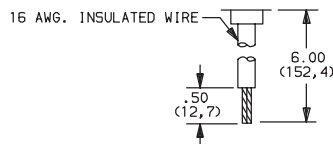

Available with 'QA' contact material only,
(UL only) SP models only.
Black wire standard, other colors and lengths available, consult Customer Service Center. UL style 1015.

ACTUATOR MARKINGS

NONE NO MARKING



D ON-OFF



P O -

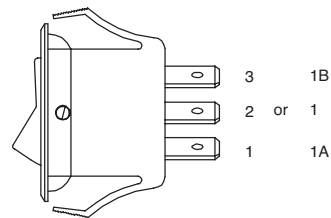
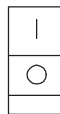

NOTE: Orientation of actuator markings and terminals.

'D, H, K & P' marking options: marking color white, standard for all actuator colors except white. Black, standard for white actuators. Consult Customer Service Center for other available markings and colors.

Shown in Pos. 1

CONTACT MATERIAL

OPTION CODE	CONTACT AND TERMINAL MATERIAL	RATINGS	
		QA	SILVER ^{1,2}
QF	15 AMPS @ 125 V AC; 10 AMPS @ 250 V AC (UL/CSA/VDE).		

* Note: See Technical Data section of this catalog for RoHS compliant and compatible definitions and specifications.

¹ STATIONARY CONTACT & TERMINALS:

All models with 'QA' rating: Copper, silver plated.
All models with 'QF' rating: Copper, silver top lay.

² MOVABLE CONTACTS: Copper, silver plated.

All models .

Only models with 'QF' rating meet international dimensional and electrical requirements .

NOTE: 'QF' rating available with '05' terminations only.

Rocker



G

C&K



Third Angle Projection

Dimensions are shown: Inches (mm)
Specifications and dimensions subject to change