



Pushbutton
A

ELUM™ Series Right Angle Illuminated Latching Pushbutton

**LEAD FREE
COMPATIBLE OPTION**

Features/Benefits

- SPDT (N.O. & N.C.)
- Low height above PCB
- Reliable self-cleaning contact
- Surface-mount or thru-hole PCB
- Standard or custom actuator
- Central LED illumination
- Latching or Momentary
- Long travel. Smooth feel
- RoHS compliant and compatible

Typical Applications

- Telecom network equipment
- Automotive electronics
- Consumer electronics
- Computer, server, modem, data storage
- Professional instrumentation, medical

Patent Numbers
6,974,924 B2 US
EP1583118B1 Europe

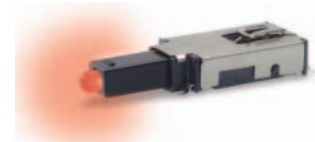

Materials

FIXED CONTACTS: Stainless steel, silver plated with gold flash
 TERMINALS: Stainless steel, silver plated
 MOVABLE CONTACTS: Copper alloy, silver plated with gold flash
 BASE: Glass filled LCP (UL94V-0)
 ACTUATOR: Glass filled nylon 4/6 (UL94V-0)
 COVER: Stainless steel

Electrical

MAXIMUM POWER: 3.5 VA
 MIN./MAX. VOLTAGE: 20 mV – 50 VDC
 MIN./MAX. CURRENT: 0.01 mA – 250 mA
 DIELECTRIC STRENGTH: ≥ 250 Vrms
 CONTACT RESISTANCE: ≤ 50 mΩ
 INSULATION RESISTANCE: ≥ 10⁹ Ω
 BOUNCE TIME: ≤ 1 ms
 LED SPECIFICATIONS: See page A-5

Mechanical

OPERATING FORCE: 2.5 N at Full Travel
 SWITCHING TRAVEL: .067" (1.7 mm)
 LATCH TRAVEL: .131" (3.6 mm)
 FULL TRAVEL: .200" (5.1 mm)

Operating Environment

OPERATING TEMPERATURE: -40°C TO 80°C.
 STORAGE TEMPERATURE: -40°C TO 80°C.
 RELATIVE HUMIDITY: 90% R.H. @ 80°C.
 OPERATING LIFE: 30,000 Cycles.
 VIBRATION: Per EIA 186-E Method
 MECHANICAL SHOCK: Per EIA 186-E Method 12.
 OVERLOAD: Withstands 40 N for 1 minute without damage

Process Environment

SOLDERABILITY: According to Mil STD 202F Method 208D or EIA RS-186E Method 9.
 LEAD FREE PROCESS COMPATIBLE: 260°C peak, 10 seconds Max. above 250° C.
 WASHING PROCESS: No clean process compatible (SMT)
 Bottom wash compatible (Thru-hole)
 SHEAR TEST (SWITCH/PCB): > 40 N

Packaging

"SA" Terminal Style SMT: Tape and reel per EIA 481-2 (450/reel)
 "TH" Terminal Style PC: Tray (60/tray)

NOTE: Any models supplied with Q, contact material are RoHS compliant.

NOTE: Specifications and materials listed above are for switches with standard options. For information on specific and custom switches, please contact Customer Service.

Build-A-Switch

To order, simply select desired option from each category and place in the appropriate box.

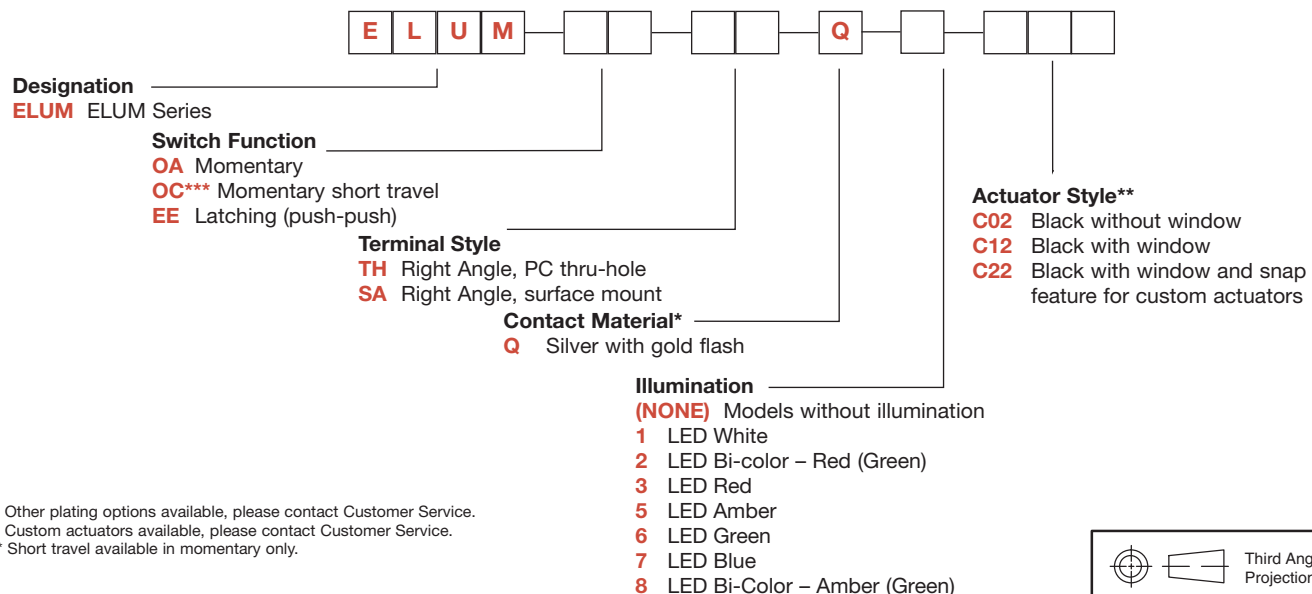

* Other plating options available, please contact Customer Service.
 ** Custom actuators available, please contact Customer Service.
 *** Short travel available in momentary only.

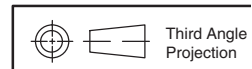

Dimensions are shown: Inches (mm)
Specifications and dimensions subject to change

ELUM™ Series Right Angle Illuminated Latching Pushbutton



A

Pushbutton

STANDARD OPTIONS

ELUMEESAQ7C12

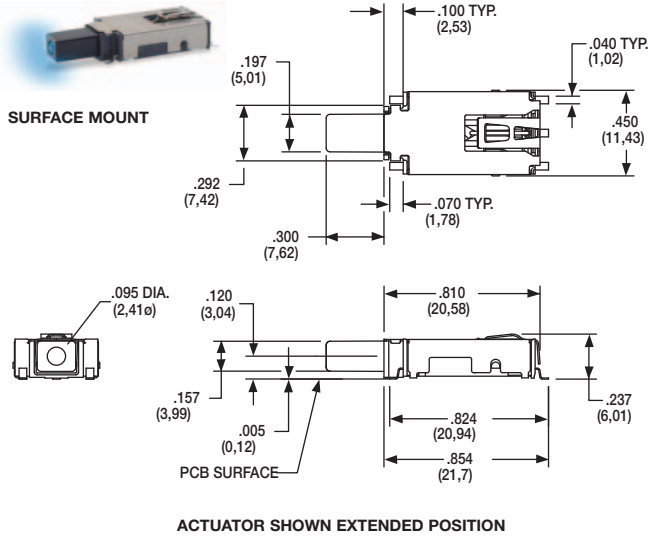

ELUMOATHQ6C12

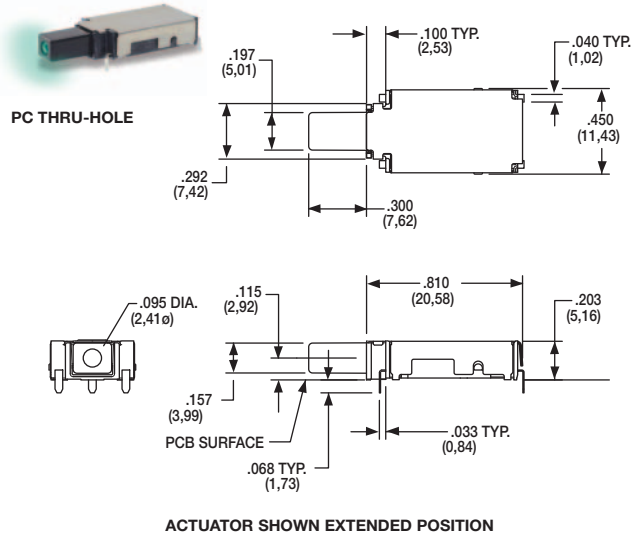

ELUMEESAQ3C22

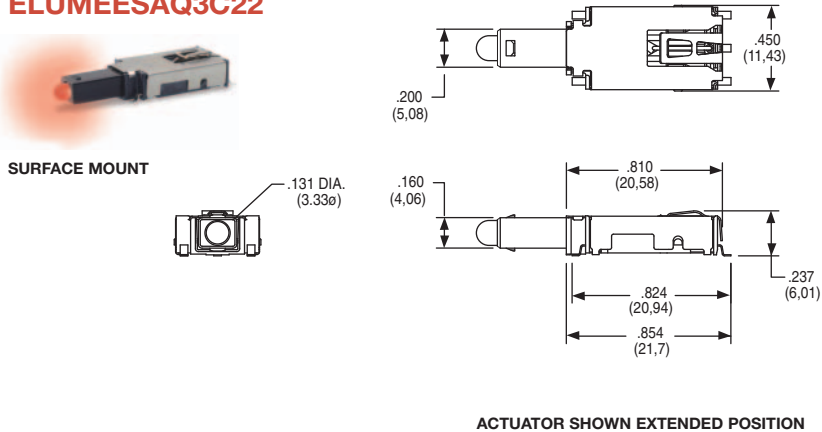

DESIGNATION

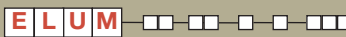

ELUM ELUM SERIES, Illuminated Latching Pushbutton

SWITCH FUNCTION



OPTION CODE	NO. OF POLES	POSITION 1	CONNECTED TERMINALS	POSITION 2	CONNECTED TERMINALS	SCHEMATIC
		ON		ON (Mom.)		
OA / OC	SP Momentary	ON	3 - 4	ON (Mom.)	3 - 2	
EE	SP Latching (Push-Push)	ON	3 - 4	ON	3 - 2	

For SPST N.O. function, only terminals 3 & 2 are used.
For SPST N.C. function, only terminals 3 & 4 are used.
Circuit: Make before break

LED pins 1 & 5 are independent of switch function.

NOTE:

For bi-color LED's the polarity must be reversed to alternate the color

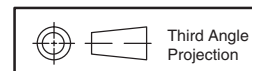
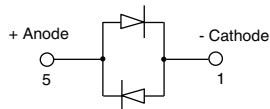

Dimensions are shown: Inches (mm)
Specifications and dimensions subject to change

www.ck-components.com



ELUM™ Series Right Angle Illuminated Latching Pushbutton

Pushbutton
A

TERMINAL STYLE



SA RIGHT ANGLE, SURFACE MOUNT

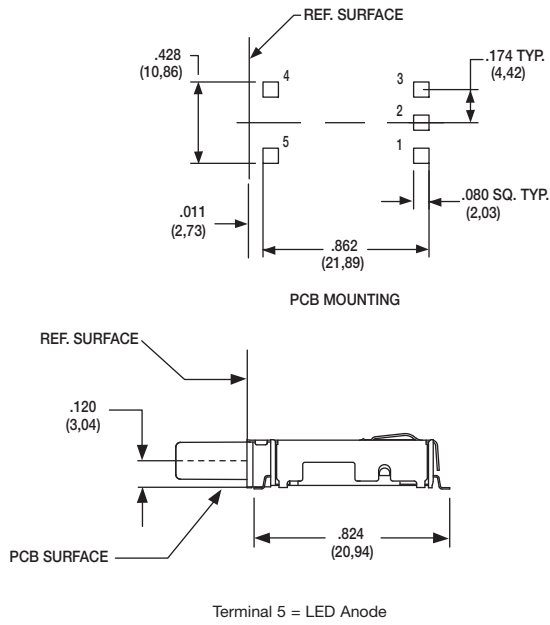

TH RIGHT ANGLE, PC THRU-HOLE

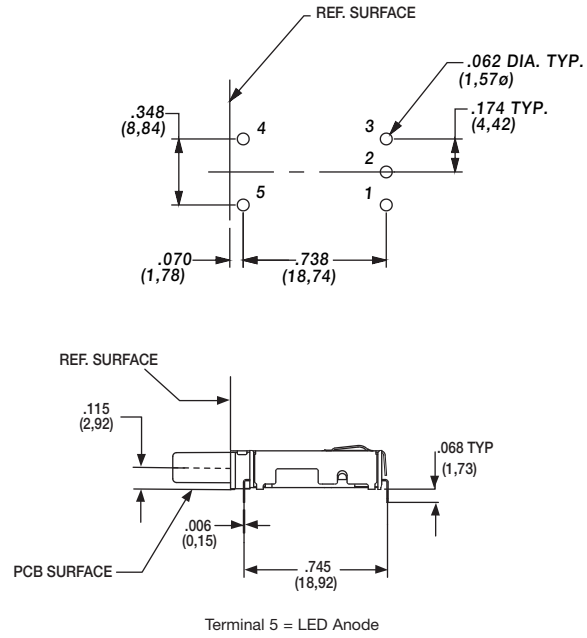

CONTACT MATERIAL



OPTION CODE	CONTACT MATERIAL	TERMINAL PLATING	RATINGS
Q	SILVER WITH GOLD FLASH	SILVER	250 mA

* Note: See Technical Data section of this catalog for RoHS compliant and compatible definitions and specifications.

FIXED CONTACTS AND TERMINALS: Stainless steel, silver plated with gold flash

MOVABLE CONTACTS: Copper alloy, silver plated with gold flash

NOTE: Any models supplied with Q, contact material are RoHS compliant.

ILLUMINATION



OPTION CODE	ILLUMINATION TYPE	TYPICAL INTENSITY* MIN	TYPICAL INTENSITY* MAX	PEAK WAVELENGTH	Vf Forward Voltage
		(mcd)		(nm)	
0	Model without illumination	N/A		N/A	
1	LED Super White	4,000	5,000	N/A	3.5
2	LED Bi-Color – Red (Green)	10	20	635/565	2.0
3	LED Red	4	8	700	2.0
5	LED Amber	35	50	610	2.0
6	LED Green	35	50	565	2.0
7	LED Super Blue	800	1,500	470	3.8
8	LED Bi-Color – Amber (Green)	10	10	585/565	2.0

*LED FORWARD CURRENT: 20 mA

LED FORWARD VOLTAGE: see chart above

LED REVERSE VOLTAGE: 5.0 V MAX

* For information on specific and custom LED, please contact Customer Service.

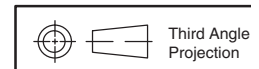

Dimensions are shown: Inches (mm)
Specifications and dimensions subject to change

ELUM™ Series Right Angle Illuminated Latching Pushbutton



A

Pushbutton

ACTUATOR STYLE*



C02 BLACK WITHOUT WINDOW

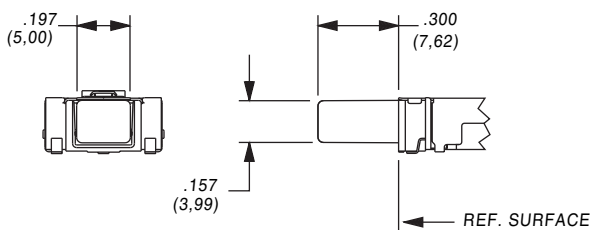

C12 BLACK WITH WINDOW

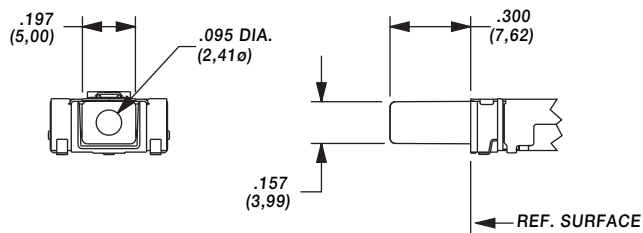

C22 BLACK WITH WINDOW AND SNAP FEATURE TO ACCEPT CUSTOM CAP

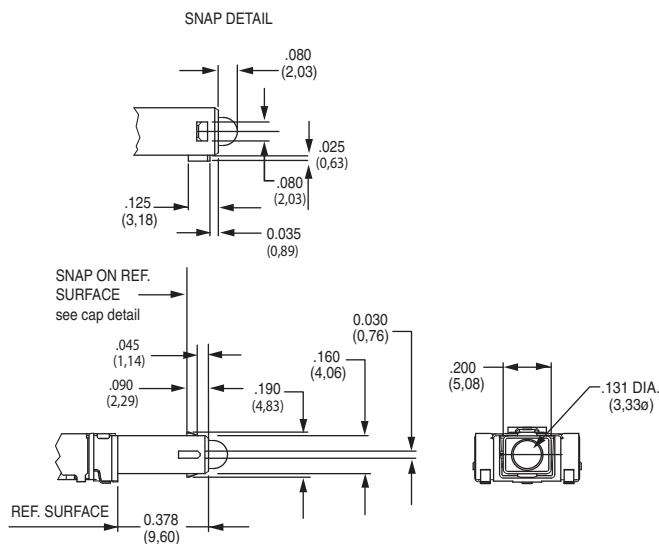

* Custom actuators available, please contact Customer Service.

FORCE TRAVEL DIAGRAM

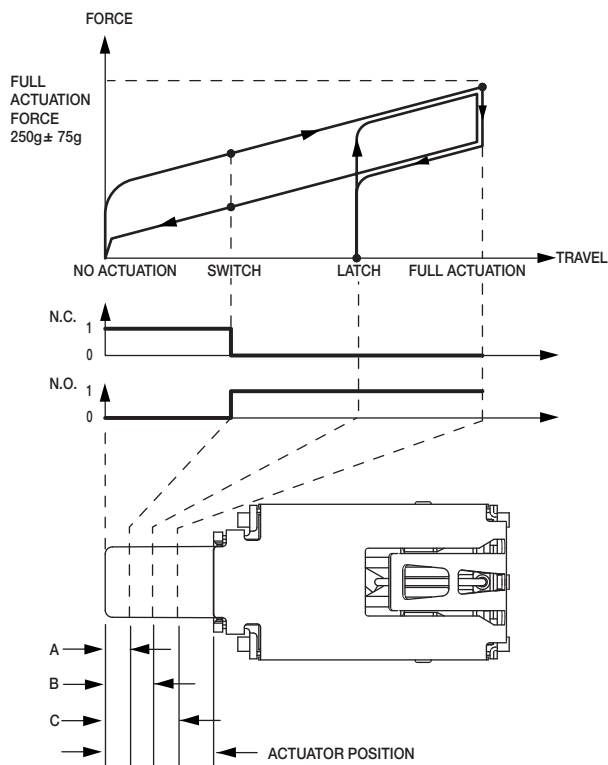

OA, EE ACTUATOR POSITION			
A	SWITCH POINT	.067 ± .020	1,7 ± 0.5mm
B	LATCH	.131 ± .020	3,3 ± 0.5mm
C	FULL ACTUATION	.200 ± .020	5,1 ± 0.5mm
OC ACTUATOR POSITION			
A	SWITCH POINT	.067 ± .020	1,7 ± 0.5mm
C	FULL ACTUATION	.098 ± .020	2,5 ± 0.5mm

TAPE & REEL

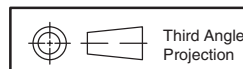
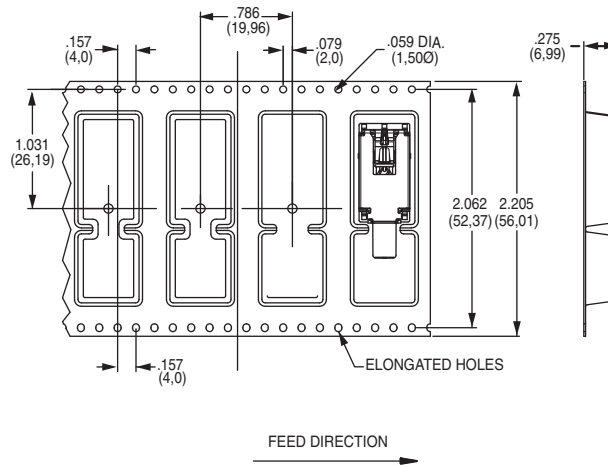

Third Angle
Projection



Dimensions are shown: Inches (mm)
Specifications and dimensions subject to change

www.ck-components.com



ELUM™ Series Right Angle Illuminated Latching Pushbutton

AVAILABLE HARDWARE

Pushbutton
A

Cap



PART NO.

957C00000 High temperature black cap with universal standby symbol

956C02000 High temperature black cap with no symbol

Material: 4/6 Nylon SMT compatible

Cap



PART NO.

181D01000 Paint and Laser Etched with black paint and universal standby symbol

Material: Clear polycarbonate

Cap



PART NO.

181D00000 Paint and laser etched with white paint underlay and black paint with universal standby symbol.

Material: Clear polycarbonate

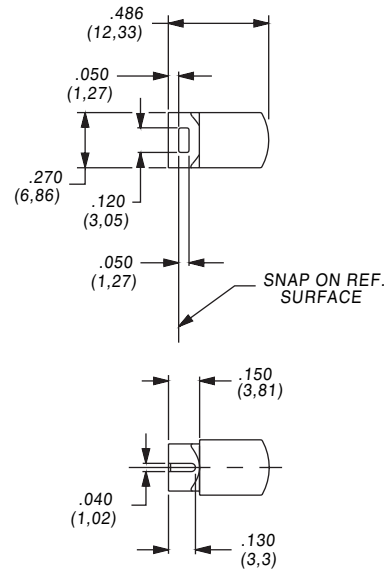

NOTE: Caps are for use with the C22 actuator style. Other colors and symbols available, consult Customer Service Center.

CAP INSTALLATION

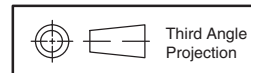
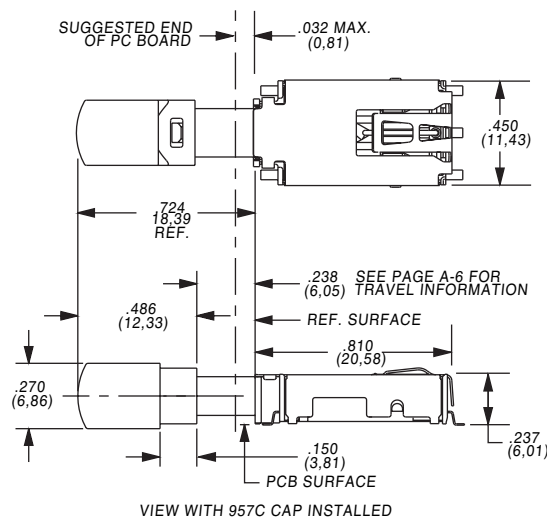

Dimensions are shown: Inches (mm)
Specifications and dimensions subject to change

www.ck-components.com