

# LCS Series Subminiature Sealed Snap-acting Switches



## Features/Benefits

- Compact design
- Long life and high electrical capacity
- Quick connect, solder terminals, PC terminals, wire leads
- Wide variety of actuator styles
- RoHS compatible, RoHS compliant
- IP67

## Typical Applications

- Motorized equipment
- Sump pump
- Thermostatic controls
- Computers
- Air conditioners

UL61058-1



## Specifications

CONTACT RATING: from low level to 5 Amp  
 ELECTRICAL LIFE: 10,000 cycles  
 INSULATION RESISTANCE: 100 M ohm min.  
 DIELECTRIC STRENGTH: 1,000 VAC  
 OPERATING TEMPERATURE:  
 -40°C to +120°C (without wire)  
 -40°C to +85°C (with UL1007 wire)  
 -40°C to +105°C (with UL1015 wire)  
 -40°C to +105°C (with UL1430 wire)  
 -40°C to +80°C (with UL1061 wire)  
 -40°C to +120°C (with UL1330 wire)  
 OPERATING FORCE: (see ACTUATOR'S option sections).  
 MOUNTING: 2-56 screws, torque 2.3 in/lbs max.

**NOTE:** Specifications and materials listed above are for switches with standard options.  
 For information on specific and custom switches, consult Customer Service center.

## Materials

SWITCH HOUSING: Thermoplastic polyester or high temperature thermoplastic (PTS) (UL 94V-0).  
 ACTUATOR BUTTON: Thermoplastic polyester.  
 SPRING: Copper alloy.  
 PIVOT: Copper alloy.  
 MOVABLE CONTACTS: Option "01" Gold plating over silver alloy Option "05" Silver alloy  
 STATIONARY CONTACTS: Option "01" Gold plating over silver alloy Option "05" Silver alloy  
 TERMINALS: Copper alloy.  
 ACTUATOR LEVEL: Stainless steel.

Snap-acting

## Build-A-Switch

To order, simply select desired option from each category and place in the appropriate box. Available options are shown and described on pages J-27 thru J-29. For additional options not shown in catalog, consult Customer Service Center.

<div style="display: flex; justify-content: space-around; align-items: center;"> <div style="border: 1px solid black; padding: 2px;">L</div> <div style="border: 1px solid black; padding: 2px;">C</div> <div style="border: 1px solid black; padding: 2px;">S</div> <div style="border: 1px solid black; width: 15px; height: 15px;"></div> <div style="border: 1px solid black; width: 15px; height: 15px;"></div> <div style="border: 1px solid black; width: 15px; height: 15px;"></div> <div style="border: 1px solid black; width: 15px; height: 15px;"></div> <div style="border: 1px solid black; width: 15px; height: 15px;"></div> <div style="border: 1px solid black; width: 15px; height: 15px;"></div> <div style="border: 1px solid black; width: 15px; height: 15px;"></div> <div style="border: 1px solid black; width: 15px; height: 15px;"></div> <div style="border: 1px solid black; width: 15px; height: 15px;"></div> <div style="border: 1px solid black; width: 15px; height: 15px;"></div> </div>											
<p><b>Series</b> LCS</p>											
<p><b>Electrical Rating</b></p> <table border="1" style="width: 100%;"> <tr> <th>Option Code</th> <th>UL cUL<sup>®</sup> US 61058-1</th> <th></th> </tr> <tr> <td>01</td> <td>0.1 A 125/250 V AC</td> <td>NA</td> </tr> <tr> <td>05</td> <td>5 A 125/250 V AC</td> <td>6 A 250 V AC</td> </tr> </table>			Option Code	UL cUL <sup>®</sup> US 61058-1		01	0.1 A 125/250 V AC	NA	05	5 A 125/250 V AC	6 A 250 V AC
Option Code	UL cUL <sup>®</sup> US 61058-1										
01	0.1 A 125/250 V AC	NA									
05	5 A 125/250 V AC	6 A 250 V AC									
<p><b>Operating Force</b> 2 203 grams</p>											
<p><b>Actuator</b>                  P00 Pin plunger                  T00 11.9 mm short lever                  T05 17.4 mm short lever                  T07 19.4 mm short lever                  T13 25.5 mm lever                  T19 33.3 mm lever                  T28 40.7 mm lever                  T43 55.9 mm lever                  S26 18.6 mm simulated lever                  A05 17.2 mm lever roller</p>											
<p><b>Terminations</b>                  S Solder                  Q 0.110 Quick Connect                  P PC Thru Hole                  W Wire leads potted                  Z Wire leads non-potted</p>											
<p><b>Wire Type AWG</b>                  20 20 AWG                  22 22 AWG                  24 24 AWG                  26 26 AWG</p>		<p><b>Wire UL # (when required)</b>                  A UL1007                  B UL1015                  C UL1430                  D UL1061</p>									
<p><b>Circuitry</b>                  C SPDT                  W SPST N.C.                  Y SPST N.O.</p>											
<p><b>Wire Side (when required)</b>                  A Wire out the bottom                  B Wire out the right side                  C Wire out the left side                  D None</p>											



Dimensions are shown: mm  
 Specifications and dimensions subject to change

# LCS Series Subminiature Sealed Snap-acting Switches

## SERIES

### LCS

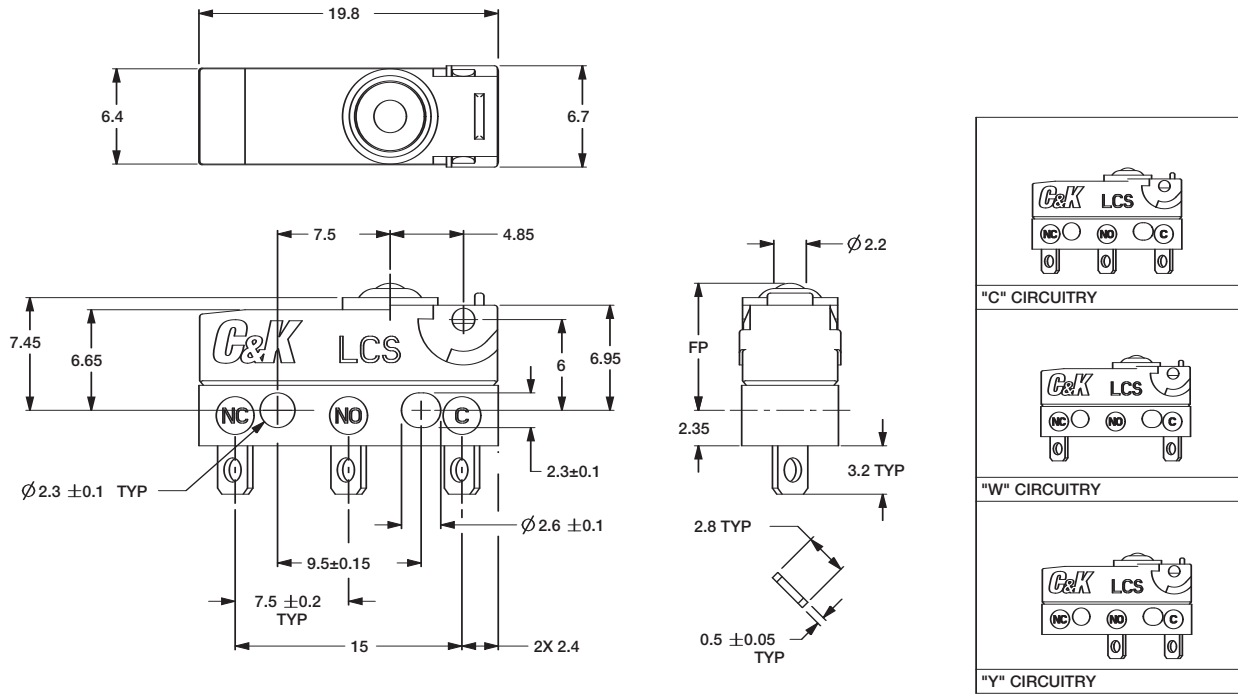

## ELECTRICAL RATING

RoHS COMPLIANT *	RoHS COMPATIBLE *	OPTION CODE	ELECTRICAL RATING
YES	YES	<b>05</b>	5 AMP, 125/250 V AC
YES	YES	<b>01</b>	0.1 AMP, 125/250 V AC

## OPERATING FORCE

OPTION CODE	OPERATING FORCES (grams)
<b>2</b>	203 g. max.



Dimensions are shown: mm  
Specifications and dimensions subject to change



Snap-acting

# LCS Series Subminiature Sealed Snap-acting Switches

ACTUATOR

P00

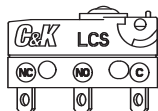

T19

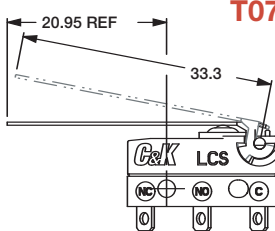

T07

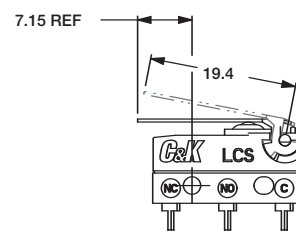

A05

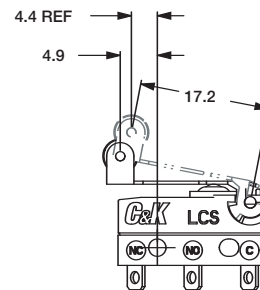

T00

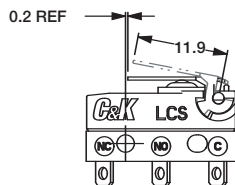

T28

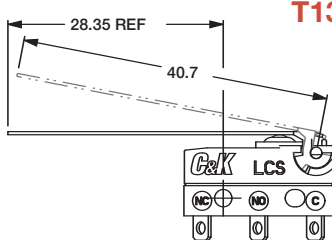

T13

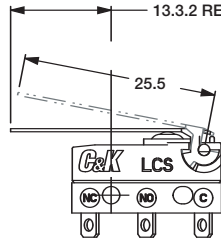

S26

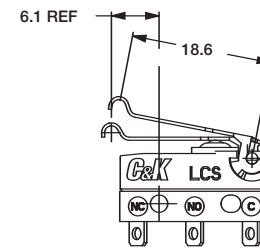

T05

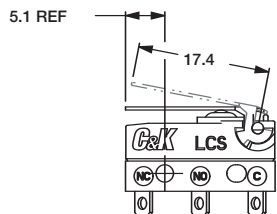

T43

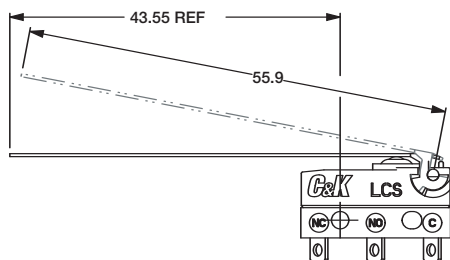

Snap-acting

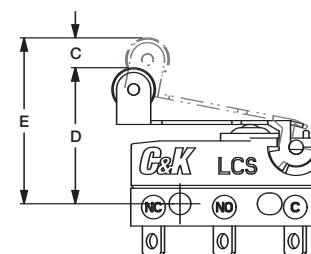
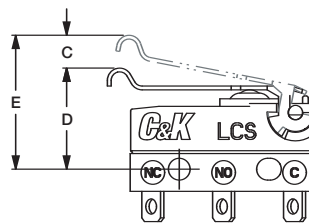
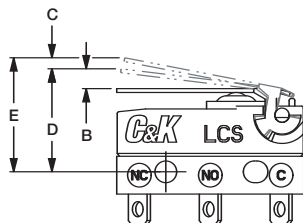
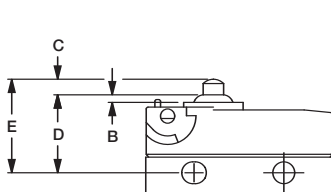

ACTUATOR OPTION CODE	A LENGTH OF LEVER	B OVER TRAVEL (MIN)	C PRE TRAVEL (MAX)	D OPERATING POSITION	E FREE POSITION (MAX)	DIFFERENTIAL MOTION (MAX)		OPERATING FORCE (MAX)		RELEASE FORCE (MIN)	
						150	203	150	203	150	203
P00	N/A	0.6	1.2	8.4 ± 3	9.9	0.2	0.2	150	203	30	50
T00	11.9	0.6	3.2	8.8 ± 9	11.1	0.5	0.5	66	98	10	21
T05	17.40	0.9	4.3	8.8 ± 1.1	12	0.6	0.6	73	82	14	16
T07	19.40	1	4.8	8.8 ± 1.2	12.4	0.7	0.7	55	66	11	13
T13	25.5	1.6	6.3	8.8 ± 1.6	13.5	0.9	0.9	29	54	6	11
T19	33.3	1.95	8	8.8 ± 2.0	15	1.75	1.75	32	40	2	5
T28	40.7	2.1	10.1	8.8 ± 2.6	16.3	2.3	2.3	33	39	1	8
T43	55.9	2.9	13.8	8.8 ± 3.5	19.1	3.6	3.6	23	33	1	7
S26	18.6	1	4.6	10.7 ± 1.2	14.1	0.65	0.65	42	68	7	14
A05	17.20	0.9	4.3	14.5 ± 1.1	17.7	0.6	0.6	54	72	4	15



Third Angle  
Projection

Dimensions are shown: mm  
Specifications and dimensions subject to change



# LCS Series Subminiature Sealed Snap-acting Switches

## TERMINATIONS

### S SOLDER

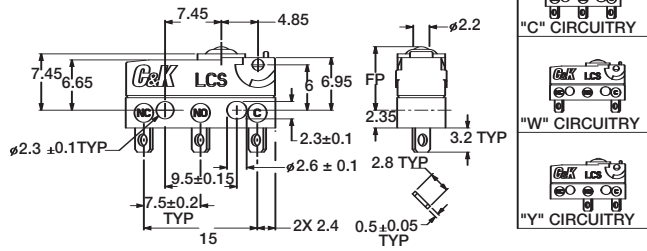

### Q QUICK CONNECT 2.8mm / 0.110"

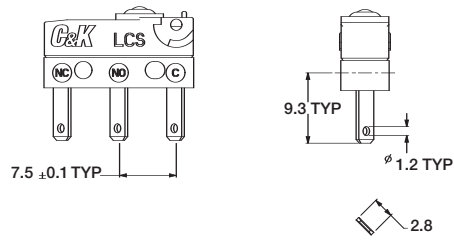

### P PC THRU HOLE

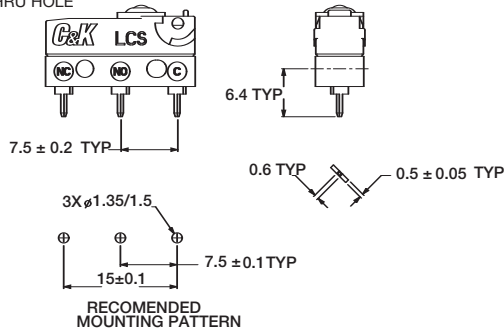

### Z or W "A" WIRE ORIENTATION

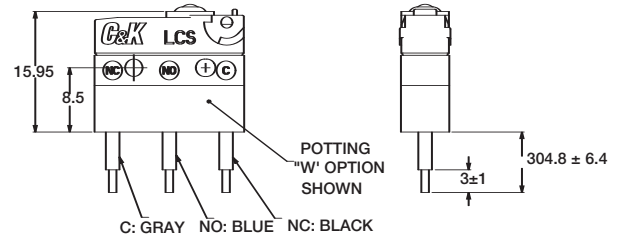

### Z or W "B" WIRE ORIENTATION "Y" OR "W" CIRCUITRY

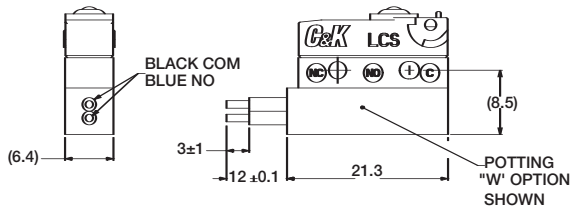

### Z or W "C" WIRE ORIENTATION "Y" OR "W" CIRCUITRY

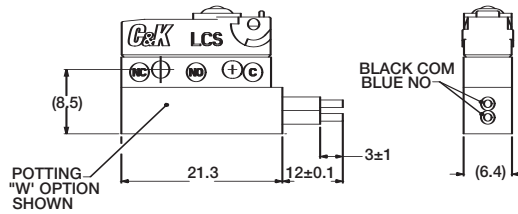

### Z or W "B" WIRE ORIENTATION "C" CIRCUITRY

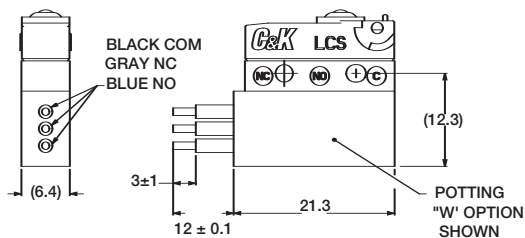

### Z or W "C" WIRE ORIENTATION "C" CIRCUITRY

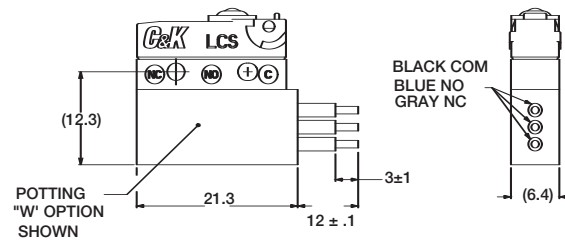

Snap-acting

## CIRCUITRY

- C** SPDT (Single Pole, Double Throw)
- W** SPST N.C. (Single Pole, Single Throw, Normally Closed)
- Y** SPST N.O. (Single Pole, Single Throw, Normally Open)

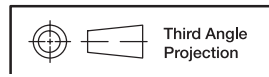

Dimensions are shown: mm  
Specifications and dimensions subject to change

