

# RTA Series

## 1-4 Poles Coded Rotary Switches



### Features/Benefits

- PCB or hand soldering versions
- Bushing mounting
- Multiple poles
- Decimal and hexadecimal codes
- Screwdriver slot or extended actuator
- RoHS Compliant

### Typical Applications

- Appliances
- Electronic alarm systems
- Medical
- Building automation
- HVAC air conditioning

### Electrical Data

	Silver	Gold
SWITCHING MODE:	BBM	BBM
MAX. SWITCHING POWER	5 VA	0.5 VA
MAX. SWITCHING CURRENT:	150 mA	20 mA
MAX. CARRYING CURRENT:	5 A	1 A
NOMINAL VOLTAGE AT 50 Hz	60 V	25 V
CONTACT RESISTANCE:	< 150 mΩ	< 150 mΩ
DIELECTRIC STRENGTH AT 50 Hz BETWEEN CONTACTS AND GROUND TERMINALS:	500 V r	500 V r
INSULATION RESISTANCE BETWEEN CONTACTS OR CONTACTS AND FRAME (500 V ⇒):	10 <sup>9</sup> Ω	10 <sup>9</sup> Ω
NO. OF OPERATIONS:	10,000	10,000
BOUNCE:	< 5 ms	< 5 ms

### Mechanical Data

MAX. NO. OF BANKS: 1.  
 OPERATING TORQUE: 5 Ncm±20%.  
 END STOP TORQUE: < 60 Ncm.  
 STOP: With/without or adjustable  
 MOUNTING: By fixed index 9.5 mm (0.374) of center, for bushing mount only

### Materials

BUSHING/HOUSING: PETP Thermoplastic  
 STATIONARY CONTACTS & TERMINALS: Nickel Plated Brass with additional plating of Gold or Silver.  
 ROTOR: Gold or Silver plated Brass or PCB.  
 CODING PLATE: PA thermoplastic  
 ACTUATOR: Polysulfon thermoplastic  
 HARDWARE: Stop pin: Aluminum. Ball & Spring: Stainless steel. Washer: PA. Nut: Brass.

### Environmental Data

OPERATING TEMPERATURE: -20°C to + 70°C    -20°C to + 70°C  
 STORAGE TEMPERATURE: -40°C to + 85°C    -40°C to + 85°C

**NOTE:** Specifications and materials listed above are for switches with standard options. For information on specific and custom switches, consult Customer Service Center.

### Build-A-Switch

To order, simply select desired option from each category and place in the appropriate box. Available options are shown and described on pages K-9 thru K-12. For additional options not shown in catalog, consult Customer Service Center.



#### Designation

**RTA**

#### Termination

- P** With PC Thru-hole
- C** With Solder Lugs
- H** Horizontal with PC Thru-hole

#### Switch Function

- 1W12** SP, 30° Index, 12 pos. no stop
- 1W10** SP, 36° Index, 10 pos. no stop
- 1S02** SP, 30° /36° Index, 2 pos.
- 1S03** SP, 30° /36° Index, 3 pos.
- 1S04** SP, 30° /36° Index, 4 pos.
- 1S05** SP, 30° /36° Index, 5 pos.
- 1S06** SP, 30° /36° Index, 6 pos.
- 1S07** SP, 30° /36° Index, 7 pos.
- 1S08** SP, 30° /36° Index, 8 pos.
- 1S09** SP, 30° /36° Index, 9 pos.
- 1S10** SP, 30° /36° Index, 10 pos.
- 1S11** SP, 30° Index, 11 pos.
- 1S12** SP, 30° Index, 12 pos.
- 2S02** DP, 30° /36° Index, 2 pos.
- 2S03** DP, 30° /36° Index, 3 pos.
- 2S04** DP, 30° /36° Index, 4 pos.
- 2S05** DP, 30° /36° Index, 5 pos.
- 2S06** DP, 30° Index, 6 pos.
- 3S02** 3P, 30° /36° Index, 2 pos.

#### Indexing

- 2** 22.5 index (coded only)
- 3** 30° index (12 positions max.)
- 4** 36° index (10 positions max.)

- 3S03** 3P, 30° /36° Index, 3 pos.
- 4S02** 4P, 30° /36° Index, 2 pos.
- EW10** Direct + complement, 36° Index, no stop
- EW12** Direct + complement, 30° Index, no stop
- DW16** Direct, 22.5° Index, no stop
- ES\_\_** Direct + complement, 30°/36° Index, with stop (specify stop position)
- DS\_\_** Direct, 22.5° Index, with stop (specify stop position)

#### Mounting Style

- W** Without bushing
- R** 3/8-32 Threaded Bushing
- M** M10x.75 Metric Threaded Bushing
- A** 3/8-32 Threaded Bushing with Offset Bracket
- B** M10x.75 Metric Threaded Bushing with Offset Bracket

#### Contact Material

- S** Silver plated, matte-tin terminal
- P** Gold plated, matte-tin terminal

#### Actuator (max.)

- 25N** .984 (25,0) with screwdriver slot
- 50N** 1.97 (50,0) with screwdriver slot
- FLS** Flush shaft with screwdriver slot and position indicator
- 25F** .984 (25,0) Shaft with flat
- 06F** .236 (6,0) Shaft with flat

- C** 3/8-32 Threaded Bushing with Straight Bracket
- D** M10x.75 Metric Threaded Bushing with Straight Bracket



Dimensions are shown: Inch (mm)  
 Specifications and dimensions subject to change

# RTA Series 1-4 Poles Coded Rotary Switches

## DESIGNATION

### RTA

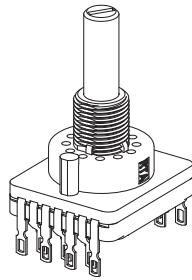

## TERMINATION

### P WITH PC PINS

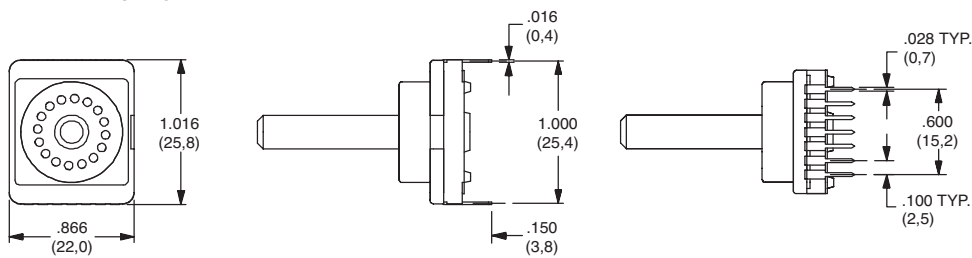

### C WITH SOLDER LUGS

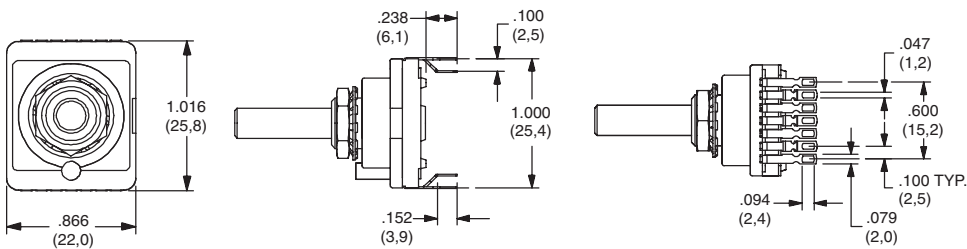

### H Horizontal with PC Thru-hole

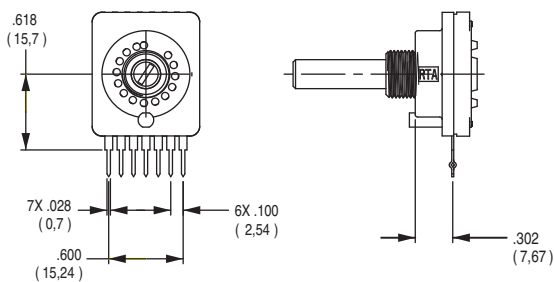

Note: "H" termination only available with the following options:

1. With A or B mounting styles
2. 36° degree indexing
3. Up to 5 positions max

## INDEXING

**2** 22.5 index, 16 positions max.

**3** 30 index, 12 positions max.

**4** 36 index, 10 positions max.

Both commons must be connected by user to ground.



Dimensions are shown: Inch (mm)  
Specifications and dimensions subject to change



K

Rotary

# RTA Series 1-4 Poles Coded Rotary Switches

## SWITCH FUNCTION

NO. POLES	MODEL NO.	SWITCH FUNCTION	INDEX
SP	1W12	12 Positions No Stop	30°
	1W10	10 Positions No Stop	36°
	1S02	2 Positions	30°/36°
	1S03	3 Positions	30°/36°
	1S05	5 Positions	30°/36°
	1S06	6 Positions	30°/36°
	1S08	8 Positions	30°/36°
	1S09	9 Positions	30°/36°
	1S10	10 Positions	30°/36°
	1S11	11 Positions	30°
1S12	12 Positions	30°	

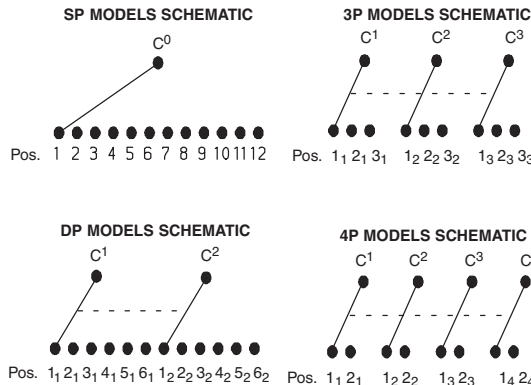

NO. POLES	MODEL NO.	SWITCH FUNCTION	INDEX
DP	2W05	5 Positions No Stop	30°/36°
	2W06	6 Positions No Stop	30°
	2S02	2 Positions	30°/36°
	2S03	3 Positions	30°/36°
	2S04	4 Positions	30°/36°
	2S05	5 Positions	30°/36°
3P	3S02	2 Positions	30°/36°
	3S03	3 Positions	30°/36°
4P	4S02	2 Positions	30°/36°

MODEL NO.	SWITCH FUNCTION	INDEX
EW10	Direct + complement, No stop	36°
EW12	Direct + complement, No stop	30°
DW16	Direct, No stop	22.5°
ES__	Direct + complement, with stop (specify stop position)	30° & 36°
DS__	Direct, with stop (specify stop position)	22.5°

22.5°	30°	36°		Pos.	1	2	3	4	5	6	7	8	9	10	11	12	13	14	15	16
E,J	M,N	L,N	C		•	•	•	•	•	•	•	•	•	•	•	•	•	•	•	•
F,I	H	D	1			•		•			•			•					•	
D,K	D	B	2				•	•				•			•					•
A,N	A	I	4						•	•	•	•						•	•	•
B	J	J	8										•	•	•	•	•	•	•	•
-	C	K	1		•					•		•			•			•		•
-	K	H	2		•	•				•	•			•	•			•	•	
-	B	A	4		•	•		•						•	•			•	•	
-	I	C	8		•	•	•	•	•	•	•	•								

### Indexing Option Code 2, 22.5 INDEXING ANGLE PCB LAYOUT

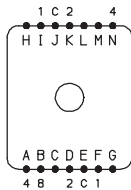

### Indexing Option Code 3, 30 INDEXING ANGLE PCB LAYOUT

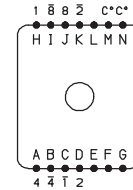
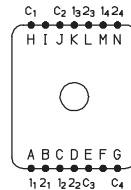
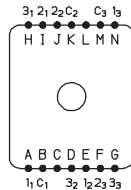
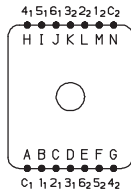
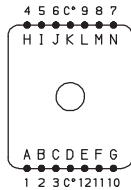

### Indexing Option Code 4, 36 INDEXING ANGLE PCB LAYOUT

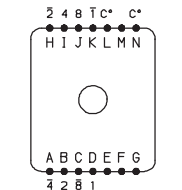
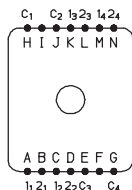
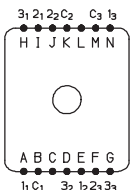
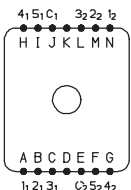
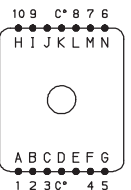

**NOTE:** Layout view from component side.

Common terminals that are in locations A-G are not connected to common terminals that are in locations H-N. For 7-12 position output customer must tie these commons together.



Dimensions are shown: Inch (mm)

Specifications and dimensions subject to change



# RTA Series 1-4 Poles Coded Rotary Switches

## MOUNTING STYLE

### W WITHOUT BUSHING



Note: W mounting style not available with H termination.

### M M10 x .75 METRIC THREADED BUSHING

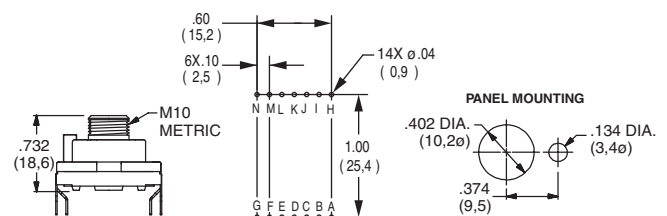

Note: M mounting style not available with H termination.

### R 3/8-32 THREADED BUSHING

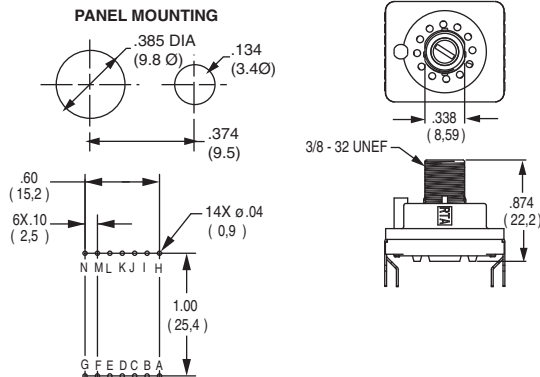

Note: R mounting style not available with H termination.

### A 3/8-32 THREADED BUSHING WITH BRACKET

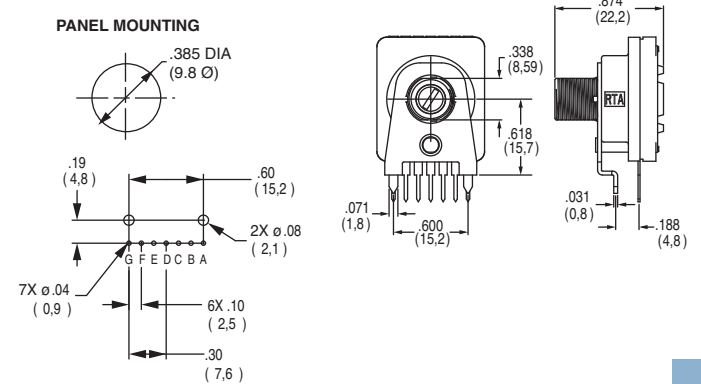

Note: A mounting style only available with H termination.

### B M10 x .75 METRIC THREADED BUSHING WITH BRACKET

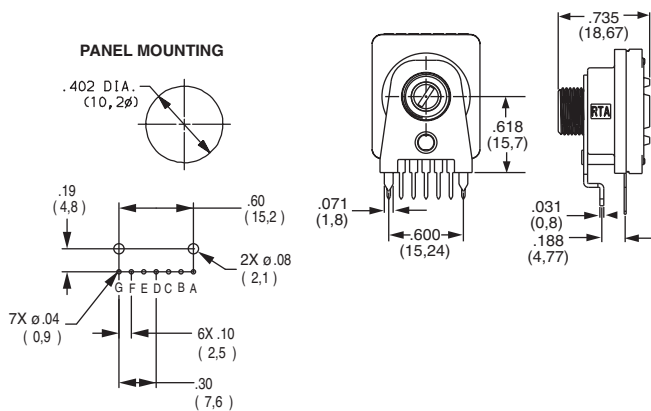

Note: B mounting style only available with H termination.

### C 3/8-32 THREADED BUSHING WITH STRAIGHT BRACKET

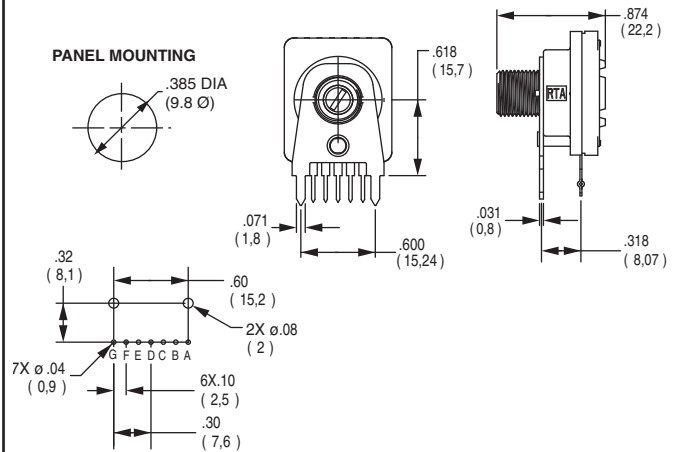

### D M10 x .75 METRIC THREADED BUSHING WITH STRAIGHT BRACKET

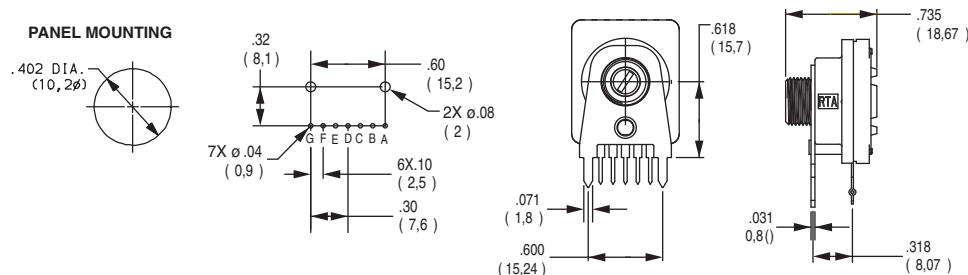

Third Angle Projection

Dimensions are shown: Inch (mm)  
Specifications and dimensions subject to change



K

Rotary

# RTA Series 1-4 Poles Coded Rotary Switches

## ACTUATOR

**25N** .984 (25,0) WITH SCREWDRIVER SLOT

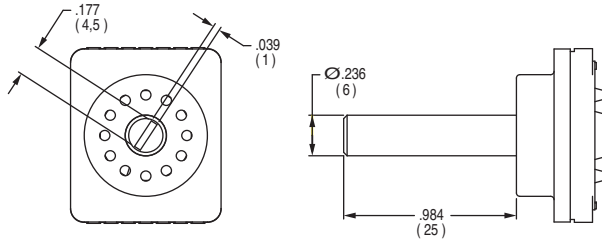

**50N** 1.97 (50,0) WITH SCREWDRIVER SLOT

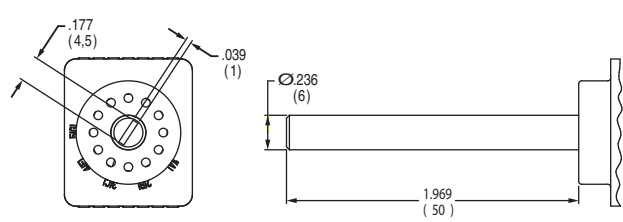

**FLS** FLUSH SHAFT WITH SCREWDRIVER SLOT AND POSITION INDICATOR

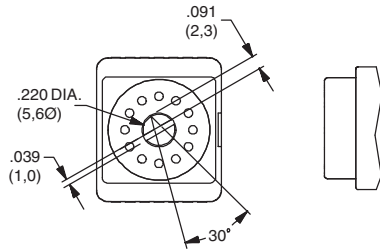

Note: only available with "W" Mounting Style

**25F** .984 (25,0) SHAFT WITH FLAT

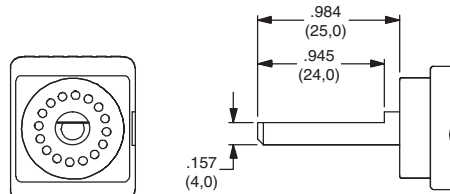

Note: only available with "W" Mounting Style

**06F** .236 (6,0) SHAFT WITH FLAT

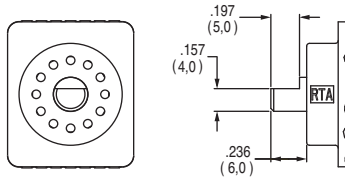

Note: only available with "W" Mounting Style

## CONTACT MATERIAL

OPTION CODE	CONTACT AND TERMINAL MATERIAL	RATING	
<b>S</b>	SILVER	LOW LEVEL/DRY CIRCUIT	SWITCH: 150 mA MAXIMUM, 60 V NOMINAL. POWER: 5 VA MAXIMUM. CARRY-5 AMPS MAXIMUM.
<b>P</b>	GOLD	LOW LEVEL/DRY CIRCUIT OR POWER	SWITCH: 20 mA MAXIMUM, 25 V NOMINAL. POWER: 0.5 VA MAXIMUM. CARRY: 1 AMP MAXIMUM.

\* Note: See Technical Data section of this catalog for RoHS compliant and compatible definition and specifications.

## AVAILABLE HARDWARE

### Mounting Nuts

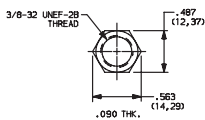

PART NO.  
**472706201**  
Standard

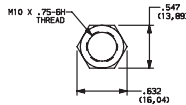

PART NO.  
**495100201**  
Metric

### Stop pins



PART NO.  
**Y200300200P**

### Lockwasher

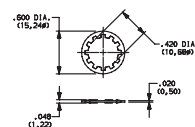

PART NO.  
**472800202**

NOTE: Additional nuts and lockwashers available separately, see section "Technical Data and Additional Hardware".



Third Angle  
Projection



Dimensions are shown: Inch (mm)  
Specifications and dimensions subject to change



K

Rotary