

4



PCB KEY SWITCHES

MICON 5 Tactile switches	4 - 3
MICON 5 - Tactile switches	4 - 5
MICON 5 - Plungers round, not illuminable	4 - 10
- NEW - MICON 5 - Plungers round, ring illumination	4 - 14
MICON 5 - Plungers square, illuminable	4 - 17
- NEW - MICON 5 - Plungers square, spot-illumination	4 - 22
MICON 5 - Plungers for signal indicator	4 - 26
RACON Tactile switches	4 - 31
RACON 8 - Tactile switches	4 - 33
RACON 12 - Tactile switches	4 - 39
RACON 12 V - Tactile switches with vertical adapter	4 - 45
RACON 12 i - Tactile switches	4 - 47
RACON 8/12 - Special accessories	4 - 49
RK 90 II, Key cap system for RACON 12	4 - 52
RF Tactile switches	4 - 55
RF 15 - Tactile switches	4 - 58
RF 15 N - Tactile switches	4 - 62
RF 15 R low - Tactile switches	4 - 67
RF 15 H - Tactile switches	4 - 73
RF 15 - Signal indicators	4 - 78
RF 19 - Tactile switches	4 - 81
RF 19 H - Tactile switches	4 - 86
RF 19 - Signal indicators	4 - 91
RF 15/19 - Special accessories	4 - 95
KN 19 Short-travel main switch	4 - 101
KN 19 - Short-travel main switches	4 - 103
RK 90 Keycaps	4 - 105
RK 90 - Keycaps, plastic, 9 x 9 mm	4 - 109
RK 90 - Keycaps, plastic 14 mm	4 - 111
RK 90 - Keycaps, aluminium, 14 mm	4 - 115
RK 90 - Special accessories	4 - 118
RG 85 III Short-travel system	4 - 121
RG 85 III - Pushbuttons/keys	4 - 125
RG 85 III - Keylock switches	4 - 128
RG 85 III - Signal indicator, without lens	4 - 131
RG 85 III - Special accessories	4 - 133
RS 76 Full-travel key switches	4 - 143
RS 76 M - Full-travel key switches, non-illuminated	4 - 150
RS 76 M - Full-travel key switches, illuminated	4 - 153
RS 76 C - Full-travel key switches, non-illuminated	4 - 156
RS 76 C - Full-travel key switches, illuminated	4 - 158
RS 76 - Keycaps, non-illuminated	4 - 161
RS 76 - Keycaps, illuminated	4 - 163
RS 76 - Keycaps, with legend, two-shot molded/keycap sets	4 - 166
RS 76 - Special accessories	4 - 168
Keylock / rotary switches for PCB	4 - 171
MICROMEK - Keylock switches IP 54	4 - 173
EUROLOCKS - Keylock switches IP 54	4 - 177
Priority keylock switches IP 54	4 - 179
Rotary switches IP40	4 - 181

PCB KEY SWITCHES

MICON 5 - TACTILE SWITCHES



MICON 5

Tactile switches

Tactile switch range MICON 5, with clear key click and extremely reliable switching. Use under overlay or under keycaps RK 90. THT and SMT versions which can be mounted automatically. All products are RoHS compliant.

4

MICON

PCB KEY SWITCHES

MICON 5 - TACTILE SWITCHES

Content

MICON 5 - Tactile switches	4 - 5
MICON 5 - Tactile switch, SMT Standard	4 - 8
MICON 5 - Tactile switch, SMT low	4 - 8
MICON 5 - Tactile switch, THT Standard	4 - 9
MICON 5 - Plungers round, not illuminable	4 - 10
MICON 5 - Plunger opaque, round, not illuminable	4 - 12
MICON 5 - Plungers round, ring illumination	4 - 14
MICON 5 - Plunger round, ring illumination	4 - 16
MICON 5 - Plungers square, illuminable	4 - 17
MICON 5 - Plunger square, illuminable, 11 x 11 mm	4 - 19
MICON 5 - Plunger square, illuminable, 14.5 x 14.5 mm	4 - 19
MICON 5 - Plunger square, illuminable, 18 x 18 mm	4 - 20
MICON 5 - Plungers square, spot-illumination	4 - 22
MICON 5 - Plunger square, spot-illumination, plunger 14.5 x 14.5 mm	4 - 24
MICON 5 - Plunger square, spot-illumination, plunger 18 x 18 mm	4 - 24
MICON 5 - Plungers for signal indicator	4 - 26
MICON 5 - Plunger for signal indicator, 1-module	4 - 28
MICON 5 - Plunger for signal indicator, 2-module	4 - 28

MICON 5 Tactile switches

→ MICON 5 tactile switches offer an extremely high switching reliability while needing very little space. They can be arranged as single keys, in rows or key blocks.

When arranged under an overlay, MICON key switches should be combined with plungers.

The features at a glance:

- Suitable for the most common soldering methods
 - Wave soldering bath for THT versions
 - Reflow soldering for SMT version
 - Vapour phase soldering for SMT versions
 - Manual soldering
- SMT version suitable for processing with an automatic SMT assembly machines
- IMDS listed

You can download actual product information from our internet site www.rafi.de / Catalogues and Downloads

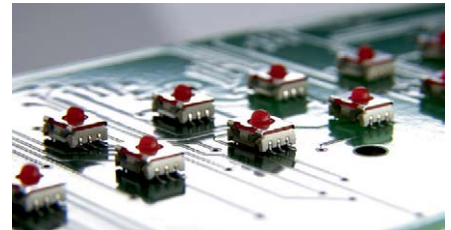
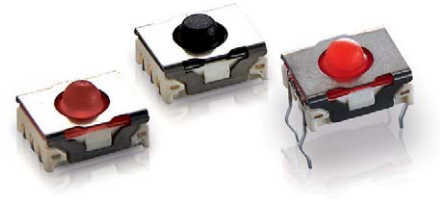

Technical Data

→ Dimensions

Length of housing	6.4 mm
Width of housing	5.1 mm
Overall height	see order block

→ Mechanical design

Mounting	soldering
Terminals	see order block
Contact system	snap-action contact
Contact arrangement	1 NO
Contact materials	Au
Illumination	no

→ Mechanical characteristics

Operating force F1 (±20%)	see order block
Switching travel S2 (±0.15 mm)	see order block

→ Electrical characteristics

Rated voltage min.	0.02 V
Rated voltage max.	35 V
Rated current min.	0.01 mA
Rated current max.	100 mA
Rated power max. (ohmic load)	1 W
Contact resistance when new	≤ 100 mΩ
Rated voltage resistance AC	250 V
Insulation resistance	10 ⁹ Ω

→ Other specifications

Ambient temp. operating min.	-40 °C
Ambient temp. operating max.	+90 °C
Resistance to environment	IEC 60068-2 -14,-30,-33, -78
Operating life (test force)	see order block
Solder heat resistance / Solderability	see order block
Flammability of materials	UL 94 V1
Packing	see order block
Produkt type	see order block
ROHS compliant	yes
REACH compliant	yes

PCB KEY SWITCHES

MICON 5 - TACTILE SWITCHES

MICON 5 Circuit diagram acc. to IEC 617

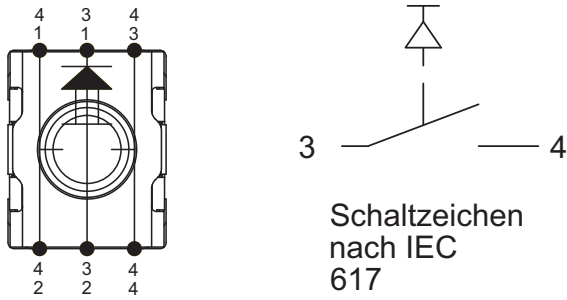

The two outer contacts must be connected.

MICON 5 Force-travel diagram

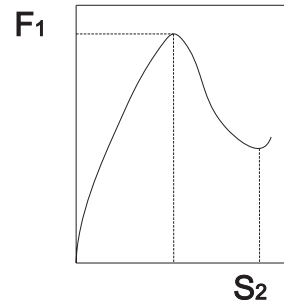

Operating force F1 and switching travel S2 see order block.

MICON 5 Product code acc. to DIN EN ISO 9001 (EN ISO 8402)

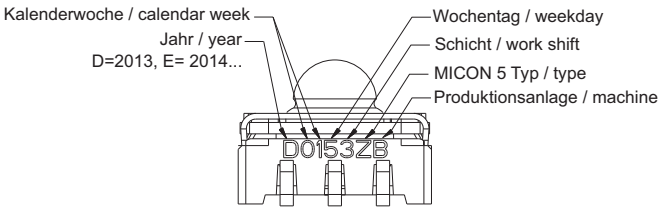

A 7-digit code is printed on the housing of the key switch. This code informs about production date, type and production shift.

Solder pad

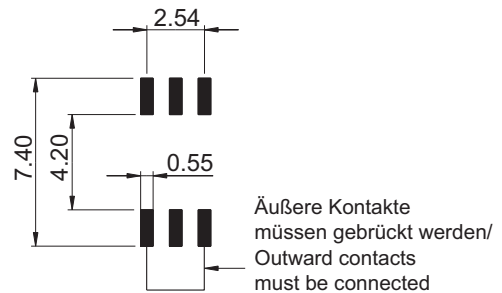

4

MICON 5 SMT version, tape and reel

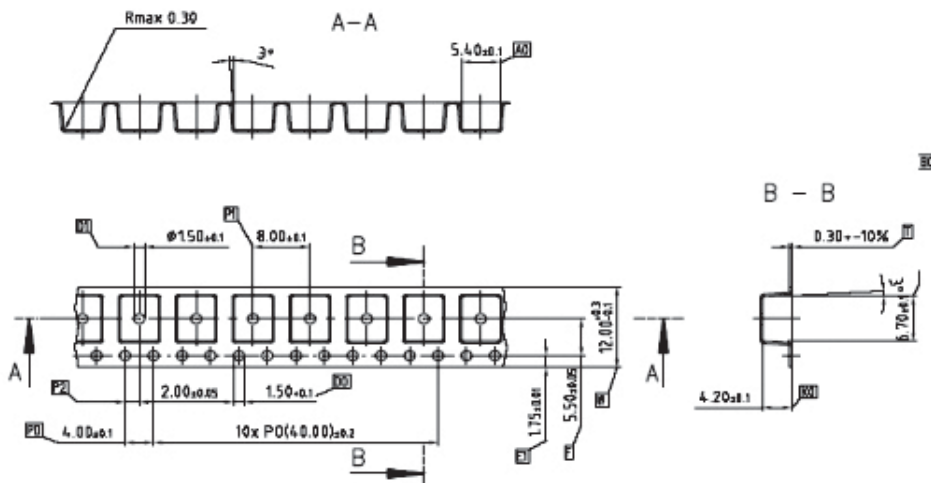

PCB KEY SWITCHES

MICON 5 - TACTILE SWITCHES

PCB pattern, smallest grid (without plungers)

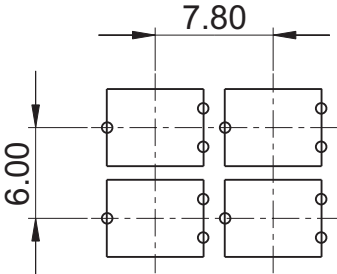

MICON 5 THT

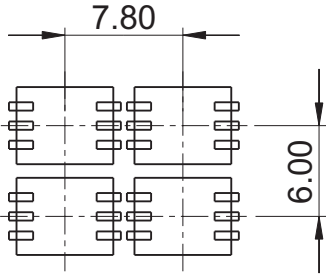

MICON 5 SMT

PCB KEY SWITCHES

MICON 5 - TACTILE SWITCHES

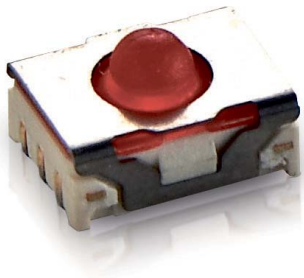

MICON 5 Tactile switch, SMT Standard

Technical data see page 4 - 5

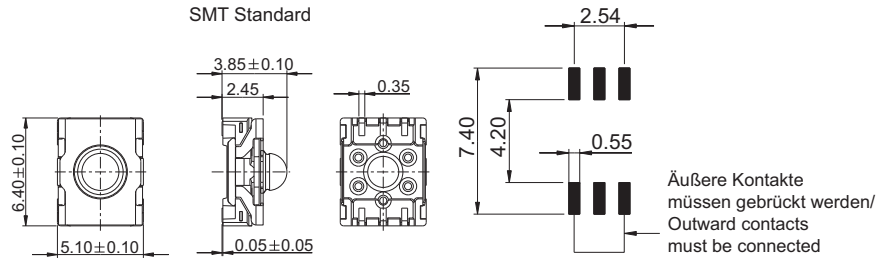

→ Produkt type	Terminals	Solder heat resistance / Solderability	Operating force F1 (±20%)	Switching travel S2 (±0.15 mm)	Operating life (test force)	Order no.
X	SMT	DIN EN 60068-2-58	3.0 N	0.7 mm	1,000,000 (4 N)	1.14.002.101/0000
Z	SMT	DIN EN 60068-2-58	3.6 N	0.8 mm	250,000 (6 N)	1.14.002.001/0000
W	SMT	DIN EN 60068-2-58	5.5 N	0.9 mm	1,000,000 (8 N)	1.14.002.111/0000
Y	SMT	DIN EN 60068-2-58	8.0 N	1.1 mm	250,000 (12 N)	1.14.002.011/0000
J	SMT	DIN EN 60068-2-58	1.5 N	0.5 mm	1,000,000 (4 N)	1.14.002.201/0000

Packing: in tape, reel with 2100 pieces
Keycaps see RK 90

Mounting hints:

Special pipette (Siemens Siplace order no.: 348514-02), mounting with collect and place head
Recommendation for screen printing: 150 µm stencil with 10% reduction of the pad size.

The key switch **1.14.002.201/0000** does not provide tactile and audible feedback. It is therefore generally used only as a **redundant auxiliary switch** to other MICON standard switches, if this is required for safety reasons.

4

MICON



MICON 5 Tactile switch, SMT low

Technical data see page 4 - 5

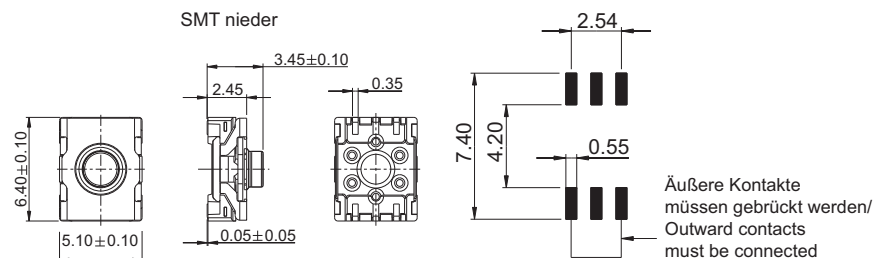

→ Produkt type	Terminals	Solder heat resistance / Solderability	Operating force F1 (±20%)	Switching travel S2 (±0.15 mm)	Operating life (test force)	Order no.
S	SMT	DIN EN 60068-2-58	3.0 N	0.6 mm	1,000,000 (4 N)	1.14.002.103/0000
T	SMT	DIN EN 60068-2-58	3.6 N	0.7 mm	250,000 (6 N)	1.14.002.003/0000

– Table (continued) –
MICON 5 - Tactile switch, SMT low

→ Produkt type	Terminals	Solder heat resistance / Solderability	Operating force F1 (±20%)	Switching travel S2 (±0.15 mm)	Operating life (test force)	Order no.
L	SMT	DIN EN 60068-2-58	5.5 N	0.7 mm	1,000,000 (8 N)	1.14.002.113/0000

Packing: in tape, reel with 2100 pieces
Keycaps see RK 90

Mounting hints:

Special pipette (Siemens Siplace order no.: 348514-02), mounting with collect and place head
Recommendation for screen printing: 150 µm stencil with 10% reduction of the pad size.

MICON 5 Tactile switch, THT Standard

Technical data see page 4 - 5

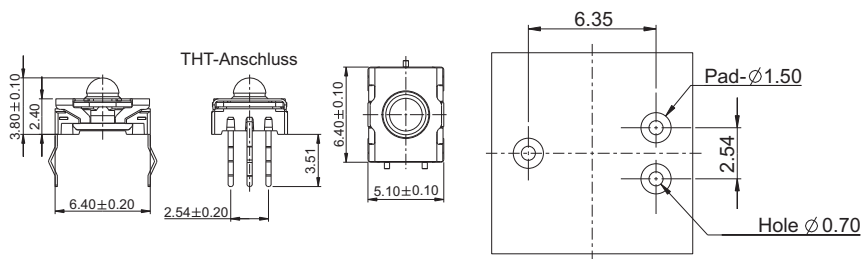

→ Produkt type	Terminals	Solder heat resistance / Solderability	Operating force F1 (±20%)	Switching travel S2 (±0.15 mm)	Operating life (test force)	Order no.
O	THT	DIN EN 60068-2-20	3.0 N	0.7 mm	1,000,000 (4 N)	1.14.002.106/0000
Q	THT	DIN EN 60068-2-20	3.6 N	0.8 mm	250,000 (6 N)	1.14.002.006/0000
N	THT	DIN EN 60068-2-20	5.5 N	0.9 mm	1,000,000 (8 N)	1.14.002.116/0000
P	THT	DIN EN 60068-2-20	8.0 N	1.1 mm	250,000 (12 N)	1.14.002.016/0000

Packing: in tubes with 102 pieces
Keycaps see RK 90

PCB KEY SWITCHES

MICON 5 - PLUNGER ROUND, NOT ILLUMINABLE

MICON 5 Plungers round, not illuminable

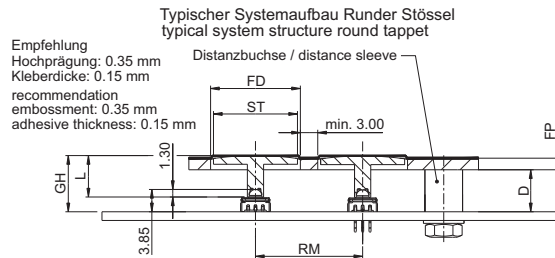

→ Description

A - Height of key switch: SMT type: 3.85 mm, THT type: 3.80 mm

D - Length of spacer $D = GH - KP - FP$

FD - Front panel cut-out $FD = ST + 1$ mm

FP - Front panel thickness

GH - Overall height: $GH = A + L1 + 0.05$ (SMT type), $GH = A + L1$ (THT type)

L - Overall length of plunger

RM - Key grid

ST - Diameter of plunger

The plungers can only be combined with MICON 5 version Standard (red bubble).

Technical Data

→ General information

Plunger diameter/size ST	see order block
Length of plunger L	see order block
Overall height GH with embossing	see order block
9.2 mm compatible	see order block

→ Other specifications

ROHS compliant	yes
REACH compliant	yes

4

MICON

Typical system design under overlay, round plungers, opaque, non-illuminable

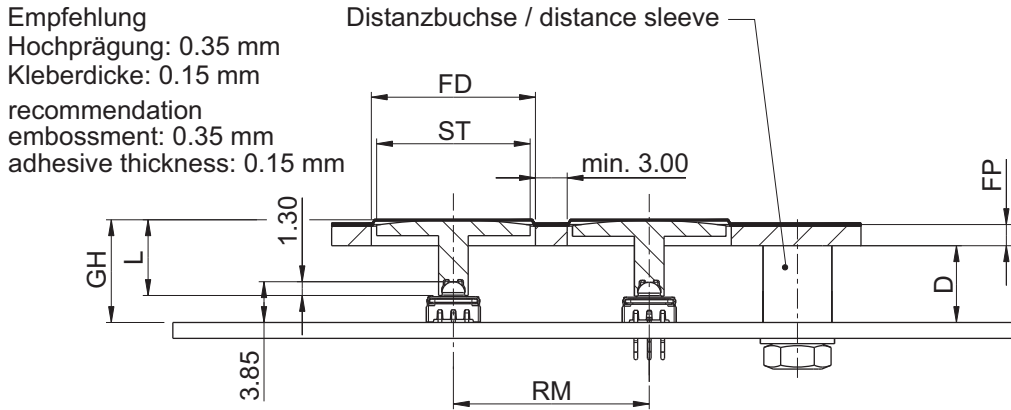

RAFI standard system design, 9.70 mm height, round plunger, opaque, non-illuminable

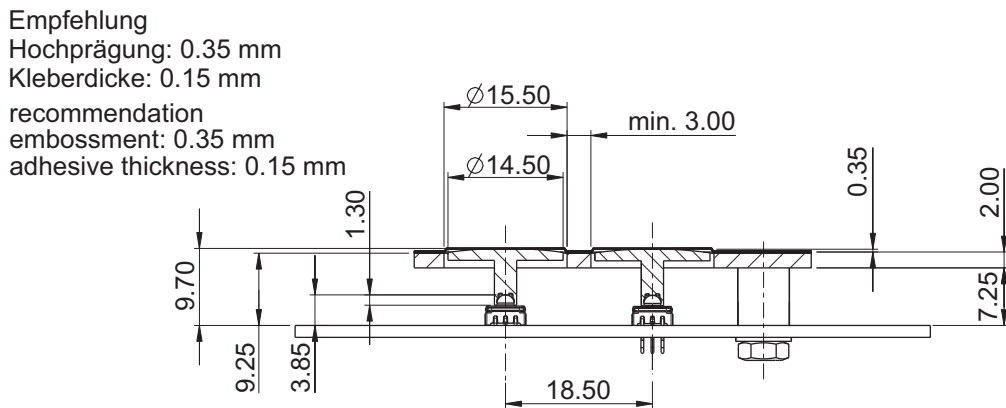

Lowest system design, 5.55 mm height, round plunger, opaque, non-illuminable

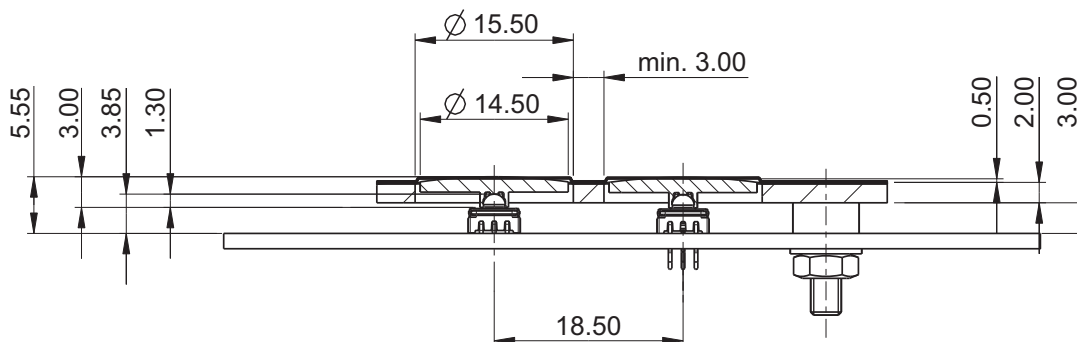

PCB KEY SWITCHES

MICON 5 - PLUNGER ROUND, NOT ILLUMINABLE



MICON 5 Plunger opaque, round, not illuminable

Technical data see page 4 - 10

→ Plunger diameter/size ST	Length of plunger L	Overall height GH with embossing	9.2 mm compatible	Order no.
6.0 mm	3.00 mm	5.55 mm	-	5.46.001.103/0200
6.0 mm	3.45 mm	6.0 mm	-	5.46.001.104/0200
6.0 mm	3.95 mm	6.5 mm	-	5.46.001.105/0200
6.0 mm	4.45 mm	7.0 mm	-	5.46.001.106/0200
6.0 mm	7.15 mm	9,7 mm	yes	5.46.001.107/0200
6.0 mm	9.95 mm	12,5 mm	-	5.46.001.108/0200
8.0 mm	3.00 mm	5.55 mm	-	5.46.001.123/0200
8.0 mm	3.45 mm	6.0 mm	-	5.46.001.124/0200
8.0 mm	3.95 mm	6.5 mm	-	5.46.001.125/0200
8.0 mm	4.45 mm	7.0 mm	-	5.46.001.126/0200
8.0 mm	5.50 mm	8.5 mm	-	5.46.001.121/0200
8.0 mm	7.15 mm	9,7 mm	yes	5.46.001.127/0200
8.0 mm	9.95 mm	12,5 mm	-	5.46.001.128/0200
8.0 mm	10.30 mm	12.85 mm	-	5.46.001.122/0200
11.5 mm	3.00 mm	5.55 mm	-	5.46.001.143/0200
11.5 mm	3.45 mm	6.0 mm	-	5.46.001.144/0200
11.5 mm	3.95 mm	6.5 mm	-	5.46.001.145/0200
11.5 mm	4.45 mm	7.0 mm	-	5.46.001.146/0200
11.5 mm	5.50 mm	8.5 mm	-	5.46.001.141/0200
11.5 mm	7.15 mm	9,7 mm	yes	5.46.001.147/0200
11.5 mm	9.95 mm	12,5 mm	-	5.46.001.148/0200
11.5 mm	10.30 mm	12.85 mm	-	5.46.001.142/0200
14.5 mm	3.00 mm	5.55 mm	-	5.46.001.163/0200
14.5 mm	3.45 mm	6.0 mm	-	5.46.001.164/0200
14.5 mm	3.95 mm	6.5 mm	-	5.46.001.165/0200
14.5 mm	4.45 mm	7.0 mm	-	5.46.001.166/0200
14.5 mm	7.15 mm	9,7 mm	yes	5.46.001.167/0200
14.5 mm	9.95 mm	12,5 mm	-	5.46.001.168/0200
19.0 mm	3.00 mm	5.55 mm	-	5.46.001.183/0200

PCB KEY SWITCHES

MICON 5 - PLUNGER ROUND, NOT ILLUMINABLE

– Table (continued) –
MICON 5 - Plunger opaque, round, not illuminable

→ Plunger diameter/size ST	Length of plunger L	Overall height GH with embossing	9.2 mm compatible	Order no.
19.0 mm	3.45 mm	6.0 mm	-	5.46.001.184/0200
19.0 mm	3.95 mm	6.5 mm	-	5.46.001.185/0200
19.0 mm	4.45 mm	7.0 mm	-	5.46.001.186/0200
19.0 mm	7.15 mm	9,7 mm	yes	5.46.001.187/0200
19.0 mm	9.95 mm	12,5 mm	-	5.46.001.188/0200

Can only be combined with MICON 5 version Standard (red bubble)

PCB KEY SWITCHES

MICON 5 - PLUNGER ROUND, RING ILLUMINATION



MICON 5 Plungers round, ring illumination



→ A MICON system design with ring illumination is only possible with the type height 9.70 mm. We recommend back printing the ring illumination area with a diffusing ink. For the actuating area, back printing with an opaque ink is recommended.

Typical system design with 9.70 mm height, round plunger, opaque, ring illumination

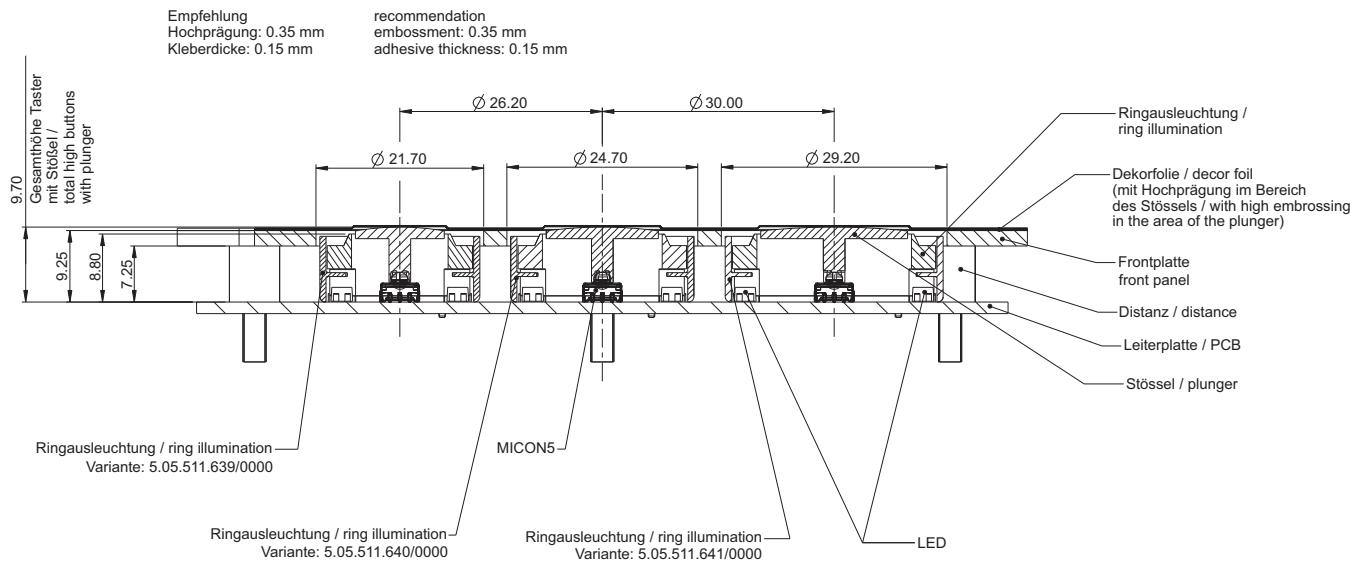

Hole pattern of PCB

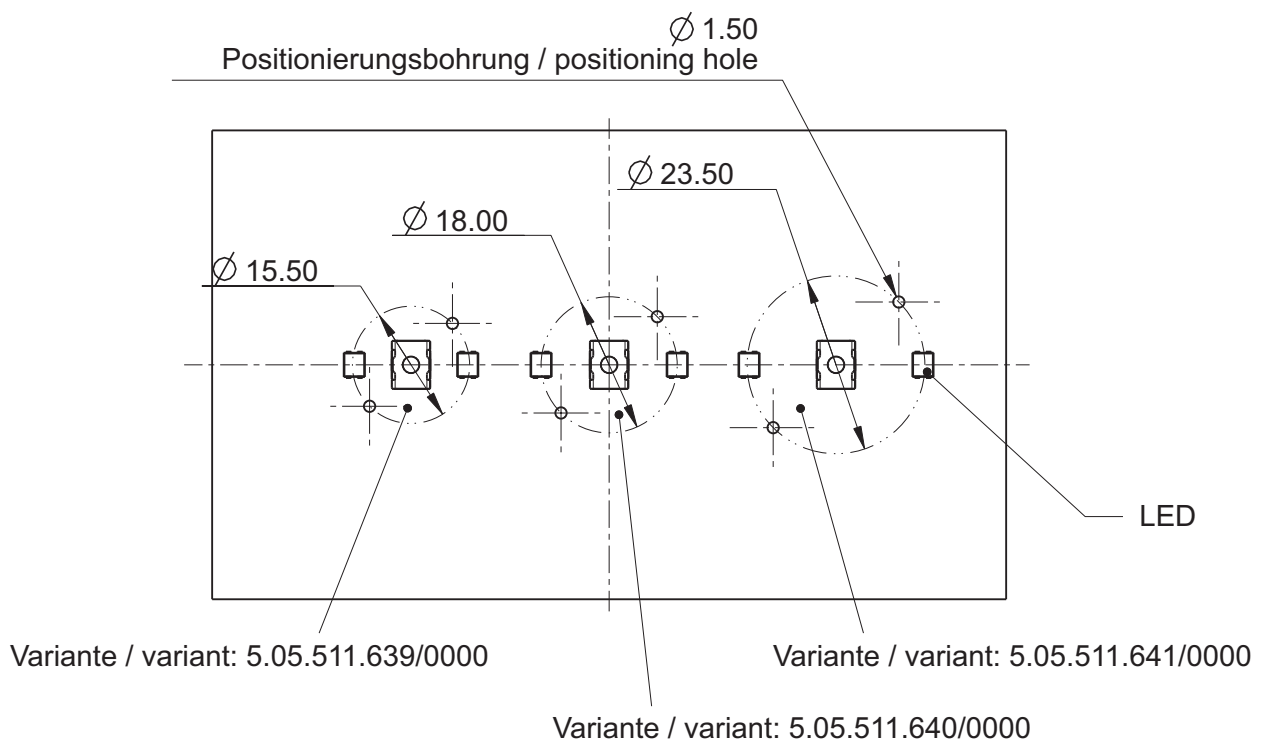

PCB KEY SWITCHES

MICON 5 - PLUNGER ROUND, RING ILLUMINATION



MICON 5 Plunger round, ring illumination



→ Plunger diameter non-illuminated	Diameter ring illumination RA	9.2 mm compatible	Overall height GH with embossing	Order no.
11.50 mm	20.70	yes	9.70 mm	5.05.511.641/0000
14.50 mm	23.70	yes	9.70 mm	5.05.511.640/0000
19.00 mm	28.20	yes	9.70 mm	5.05.511.639/0000

Plunger round, not illuminable is included in delivery.

MICON 5 Plungers square, illuminable

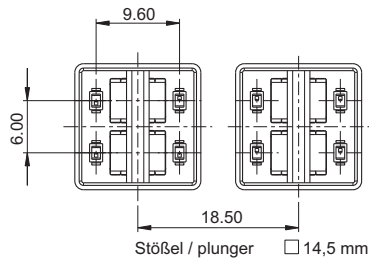

Pic. with 4 LED OSRAM LO M676-Q1R1-24

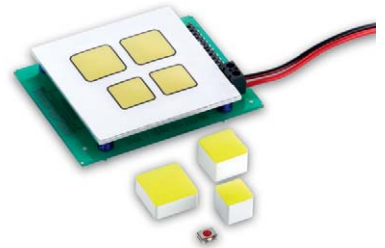

→ Description

- A - Height of key switch: SMT = 3.85 mm, THT = 3.80 mm
 - B - Width of plunger (11 x 11 mm, 14,5 x 14,5 mm or 18 x 18 mm)
 - D - GH - FP - 0.5 mm (= embossing height 0.35 mm + glue height 0.15 mm)
 - FD - Front panel cut-out: B + 1 mm
 - FP - Thickness of front plate
 - GH - Overall height: A + 5.75 mm
 - KS - Glue strip min. 3 mm
 - R - Grid size: FD + KS
- The plungers can only be combined with MICON 5 version Standard (red bubble).

Technical Data

→ General information

Overall height GH	see order block
Color of lens	see order block

→ Other specifications

ROHS compliant	yes
REACH compliant	yes

PCB KEY SWITCHES

MICON 5 - PLUNGER SQUARE, ILLUMINABLE

Typical system design under overlay, square plungers, illuminable

Aufbau:
Hochprägung 0.35 mm
Klebedicke 0.15 mm
assembly:
embossment: 0.35 mm
adhesive thickness: 0.15 mm

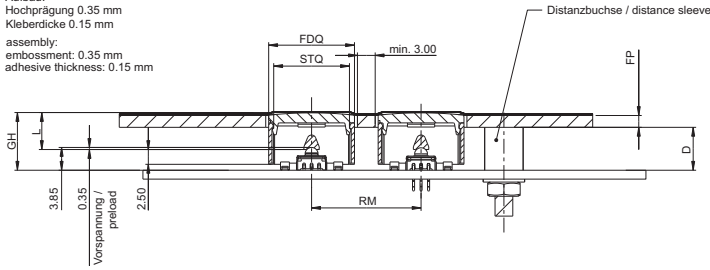

D - Distanzlänge / distance length $D = GH - FP - 0.5$
(Prägehöhe / embossing height
+ Klebedicke / adhesive thickness)

L - Stößellänge / tappet length

STQ - Breite quadratischer Stößel / width square tappet

FDQ - Quadratischer Frontplattendurchbruch /
square front panel breakthrough $FDQ = STQ + 1\text{ mm}$

FP - Frontplattenstärke / Panel thickness

RM - Rastermaß / grid dimensions $RM = FDQ + \text{min. } 3\text{ mm}$

RAFI standard system design, 9.70 mm height, square plunger, illuminable

Aufbau:
Hochprägung 0.35 mm
Klebedicke 0.15 mm
assembly:
embossment: 0.35 mm
adhesive thickness: 0.15 mm

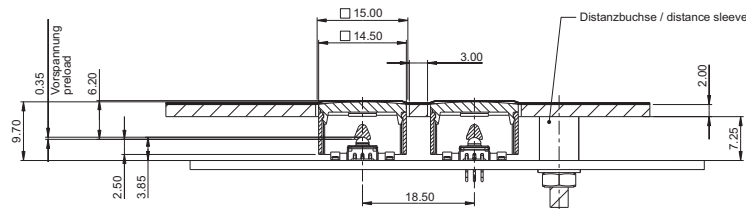

Possible arrangement of LEDs with square plunger, illuminable

View without frontpanel, overlay and lens

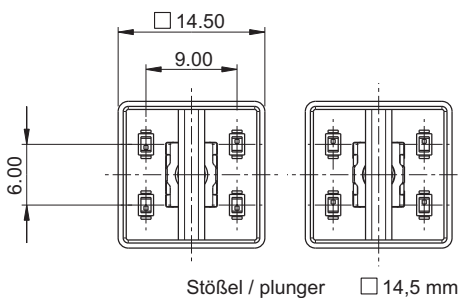
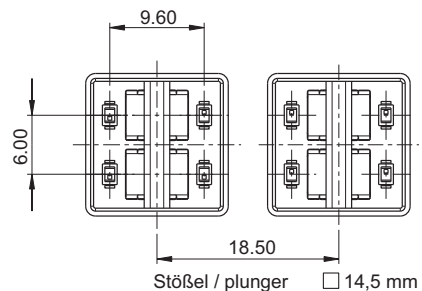
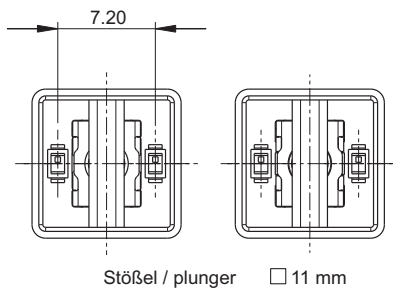

4

MICON

MICON 5 Plunger square, illuminable, 11 x 11 mm

Technical data see page 4 - 17



Platzierungsmöglichkeiten der LED's
(Ansicht ohne Frontplatte, Folie und Blende)
placement options of the LEDs
(view without front panel, foil and lens)

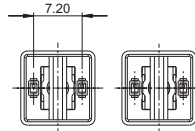

Stößel / plunger □ 11 mm

Pic. with 2 LED OSRAM LO M676-Q1R1-24

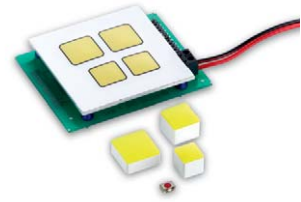

→ Overall height GH	Color of lens	Order no.
9.70 mm	red	5.05.511.470/2300
12.50 mm	red	5.05.511.471/2300
9.70 mm	yellow	5.05.511.470/2400
12.50 mm	yellow	5.05.511.471/2400
9.70 mm	green	5.05.511.470/2500
12.50 mm	green	5.05.511.471/2500
9.70 mm	blue	5.05.511.470/2600
12.50 mm	blue	5.05.511.471/2600
9.70 mm	white	5.05.511.470/2200
12.50 mm	white	5.05.511.471/2200

Can only be combined with MICON 5 version Standard (red bubble)

MICON 5 Plunger square, illuminable, 14.5 x 14.5 mm

Technical data see page 4 - 17

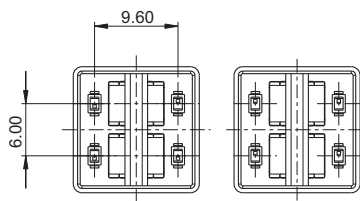

Stößel / plunger □ 14,5 mm

Pic. with 4 LED OSRAM LO M676-Q1R1-24

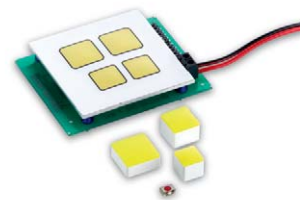

PCB KEY SWITCHES

MICON 5 - PLUNGER SQUARE, ILLUMINABLE

– Table (continued) –

MICON 5 - Plunger square, illuminable, 14.5 x 14.5 mm

→ Overall height GH	Color of lens	Order no.
9.70 mm	red	5.05.511.475/2300
12.50 mm	red	5.05.511.476/2300
9.70 mm	yellow	5.05.511.475/2400
12.50 mm	yellow	5.05.511.476/2400
9.70 mm	green	5.05.511.475/2500
12.50 mm	green	5.05.511.476/2500
9.70 mm	blue	5.05.511.475/2600
12.50 mm	blue	5.05.511.476/2600
9.70 mm	white	5.05.511.475/2200
12.50 mm	white	5.05.511.476/2200

Can only be combined with MICON 5 version Standard (red bubble)

MICON 5 Plunger square, illuminable, 18 x 18 mm

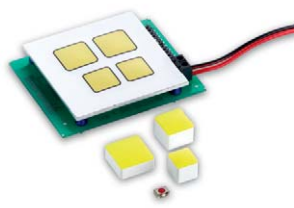

Technical data see page 4 - 17



Platzierungsmöglichkeiten der LED's
(Ansicht ohne Frontplatte, Folie und Blende)
placement options of the LEDs
(view without front panel, foil and lens)

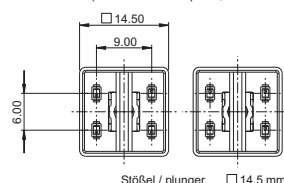

→ Overall height GH	Color of lens	Order no.
9.70 mm	red	5.05.511.480/2300
12.50 mm	red	5.05.511.481/2300
9.70 mm	yellow	5.05.511.480/2400
12.50 mm	yellow	5.05.511.481/2400
9.70 mm	green	5.05.511.480/2500
12.50 mm	green	5.05.511.481/2500
9.70 mm	blue	5.05.511.480/2600
12.50 mm	blue	5.05.511.481/2600
9.70 mm	white	5.05.511.480/2200
12.50 mm	white	5.05.511.481/2200

4

MICON

PCB KEY SWITCHES

MICON 5 - PLUNGER SQUARE, ILLUMINABLE

– Table (continued) –

MICON 5 - Plunger square, illuminable, 18 x 18 mm

Can only be combined with MICON 5 version Standard (red bubble)

PCB KEY SWITCHES

MICON 5 - SQUARE PLUNGERS, SPOT-ILLUMINATION



MICON 5 Plungers square, spot-illumination



Technical Data

→ General information

Overall height GH with embossing	9.70 mm
Color of lens	white
Dimensions	see order block

→ Other specifications

ROHS compliant	yes
REACH compliant	yes

RAFI standard system design, 9.70 mm height, square plunger, spot-illumination

Aufbau:
 Hochprägung 0.35 mm
 Kleberdicke 0.15 mm
 assembly:
 embossment: 0.35 mm
 adhesive thickness: 0.15 mm

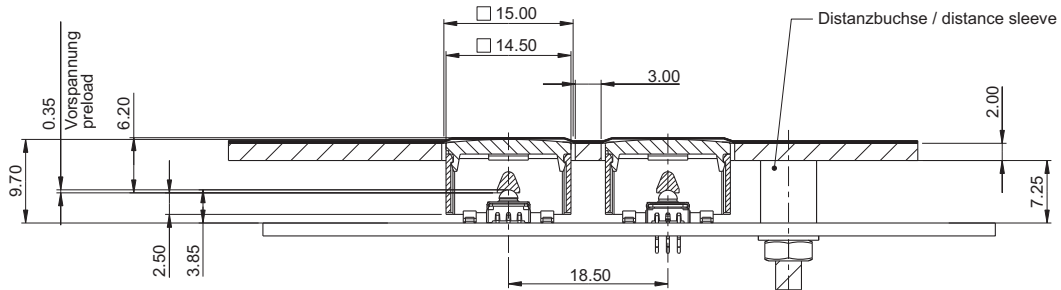

Possible arrangement of LEDs with square plunger, spot illumination, 14,5 x 14,5 mm

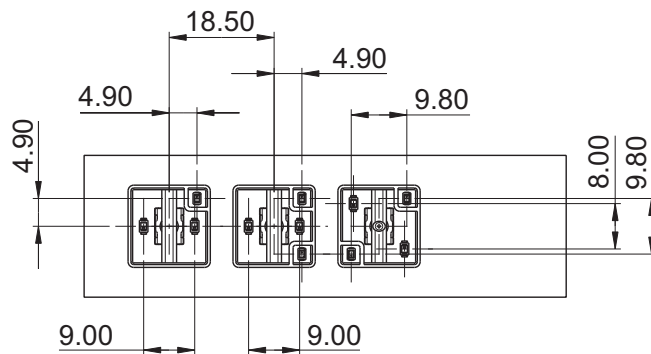

Possible arrangement of LEDs with square plunger, spot illumination, 18 x 18 mm

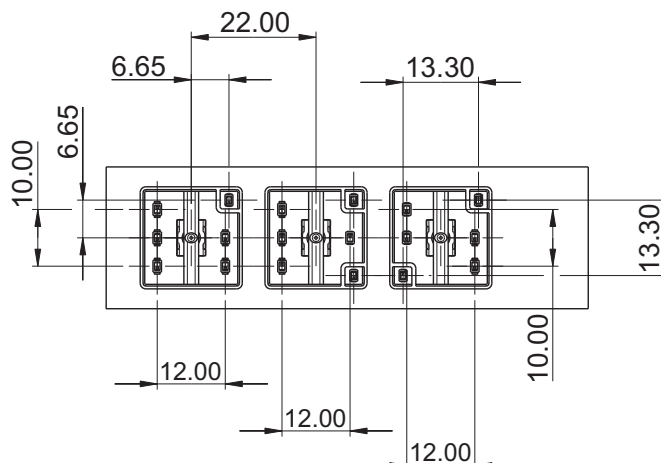

PCB KEY SWITCHES

MICON 5 - SQUARE PLUNGERS, SPOT-ILLUMINATION



MICON 5 Plunger square, spot-illumination, plunger 14.5 x 14.5 mm

Technical data see page 4 - 22



→ Overall height GH with embossing	Spot-illumination	Color of lens	Dimensions	Order no.
9.70 mm		white	14.5 x 14.5	5.05.511.649/2200
9.70 mm		white	14.5 x 14.5	5.05.511.650/2200
9.70 mm		white	14.5 x 14.5	5.05.511.651/2200

4



MICON 5 Plunger square, spot-illumination, plunger 18 x 18 mm

Technical data see page 4 - 22



→ Overall height GH with embossing	Spot-illumination	Color of lens	Dimensions	Order no.
9.70 mm		white	18 x 18	5.05.511.658/2200
9.70 mm		white	18 x 18	5.05.511.659/2200
9.70 mm		white	18 x 18	5.05.511.660/2200



GET IN TOUCH

The uniqueness of the moment

Whenever a pushbutton or switch made by RAFI is used, the company's technology ensures that proper contact is made. For over 100 years now, we have driven innovation in human-machine communication and set standards across the globe. From operating elements and highly intelligent data entry systems to complete custom solutions from one source – all of our products are developed to meet the requirements of our long-standing customers. The results are excellent: close business relationships, innovative products and motivated employees.

Visit our website to learn more about RAFI.

www.rafi.de

RAFI

PCB KEY SWITCHES

MICON 5 - PLUNGER FOR SIGNAL INDICATOR



MICON 5 Plungers for signal indicator

Technical Data

→ **General information**

Overall height GH with embossing	9.70 mm
Lens color	white
Dimensions	see order block

→ **Other specifications**

ROHS compliant	yes
REACH compliant	yes

PCB KEY SWITCHES

MICON 5 - PLUNGER FOR SIGNAL INDICATOR

RAFI standard system design, 9.70 mm height, signal indicator

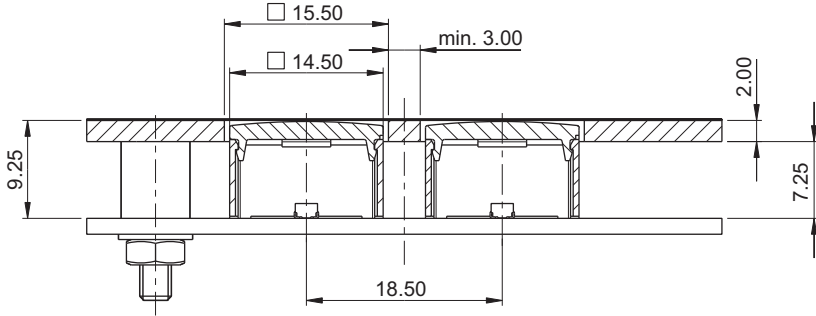

Possible arrangement of LEDs with signal indicator

LED Platzierung mit Leuchtfeld 14.5x14.5
LED placement with light field 14.5 x14.5

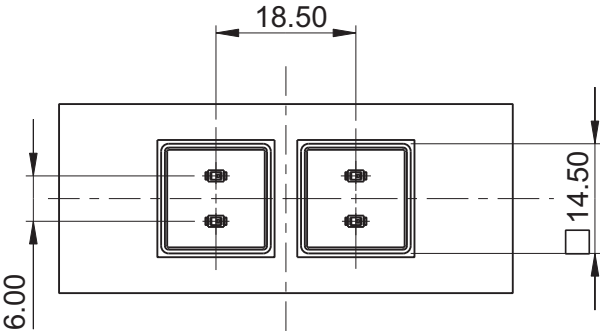

PCB KEY SWITCHES

MICON 5 - PLUNGER FOR SIGNAL INDICATOR



MICON 5 Plunger for signal indicator, 1-module

Technical data see page 4 - 26

LED Platzierung mit Leuchtfeld 11x11
LED placement with light field 11x11

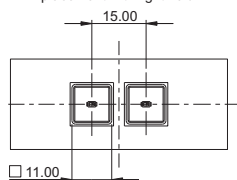

LED Platzierung mit Leuchtfeld 14.5x14.5
LED placement with light field 14.5 x14.5

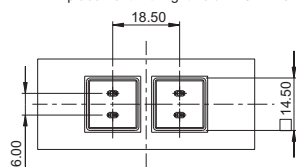

LED Platzierung mit Leuchtfeld 18x18
LED placement with light field 18x18

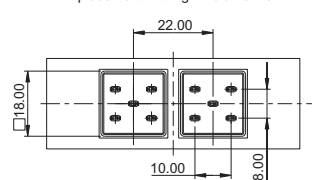

→ Overall height GH with embossing	Lens color	Dimensions	Order no.
9.70 mm	white	11 x 11 mm	5.05.005.182/2200
9.70 mm	white	14.5 x 14.5 mm	5.05.005.175/2200
9.70 mm	white	18 x 18 mm	5.05.005.176/2200

MICON 5 Plunger for signal indicator, 2-module

Technical data see page 4 - 26

LED Platzierung mit Leuchtfeld 14.5x29
LED placement with light field 14.5 x29

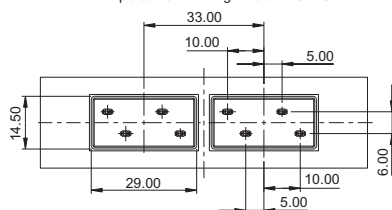

LED Platzierung mit Leuchtfeld 18x36
LED placement with light field 18x36

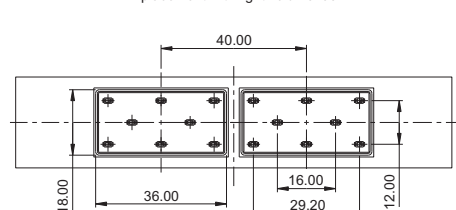

→ Overall height GH with embossing	Lens color	Dimensions	Order no.
9.70 mm	white	14.5 x 29 mm	5.05.005.177/2200
9.70 mm	white	18 x 36 mm	5.05.005.178/2200

4



MICON

Redundant system design with illuminable plungers MICON 1.14.002.201, 1.5 N

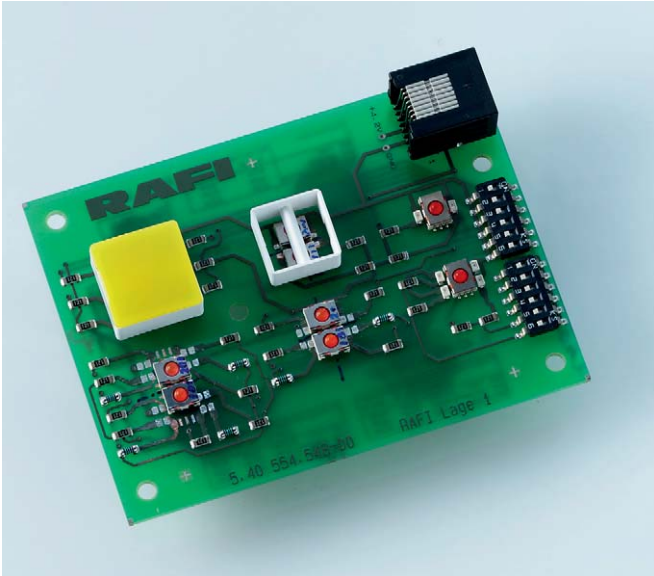

The tactile switch type **1.14.002.201/0000** is designed only for use in a **redundant system** with another SMT switch of standard height. For a redundant system design, the plunger sizes 14.5 x 14.5 mm or 18 x 18 mm must be used.

View without front panel, overlay and lens

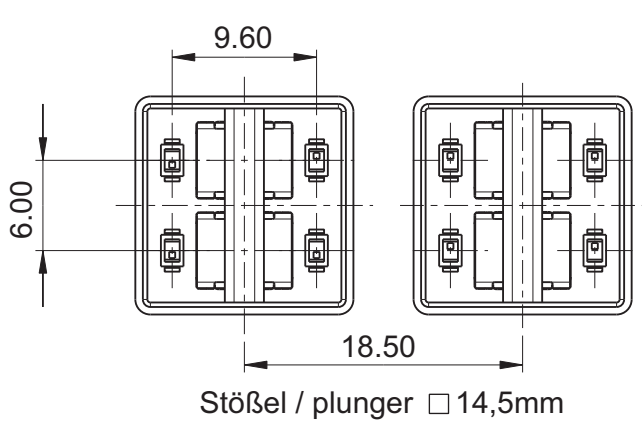

Plunger 14,5 x 14,5 mm

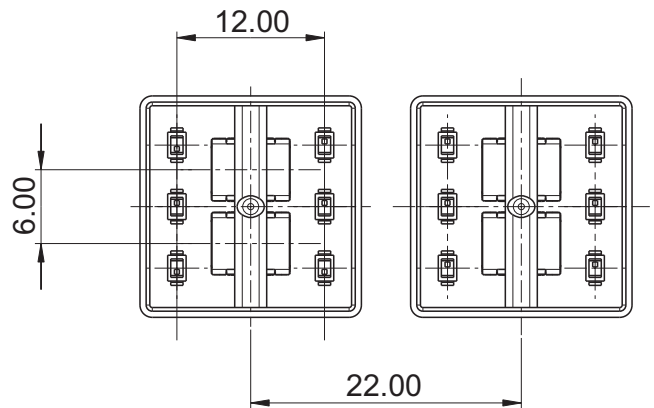

Plunger 18 x 18 mm

PCB KEY SWITCHES

MICON 5 - PLUNGER FOR SIGNAL INDICATOR

Typical system design RK 90 degree of protection IP 65

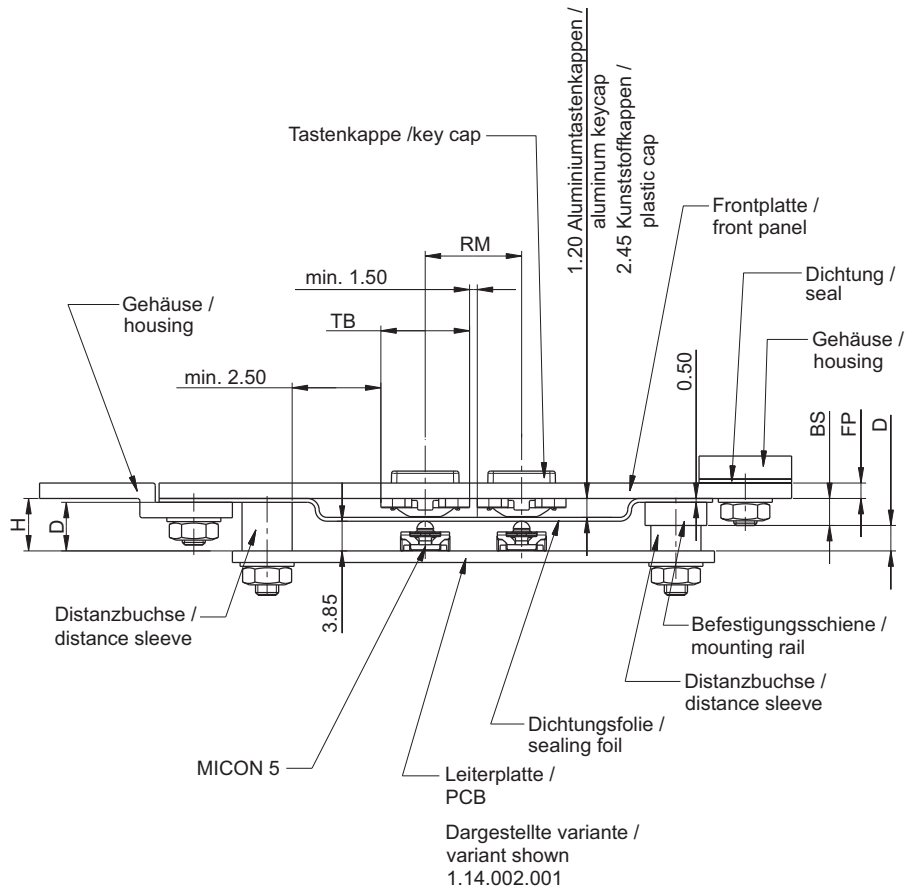

4

Typical system design RK 90 degree of protection IP 40

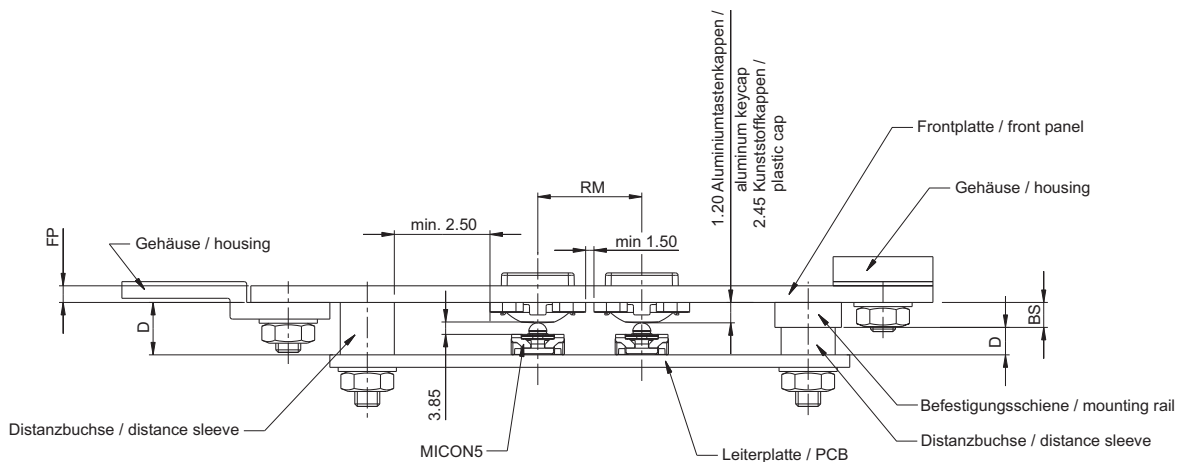

PCB KEY SWITCHES

RACON - TACTILE SWITCHES

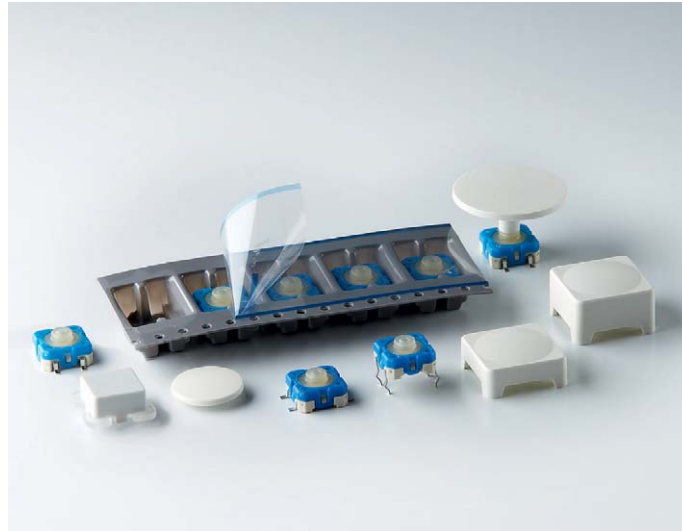

RACON

Tactile switches

RACON tactile switches distinct key click, excellent switching reliability. For use under an overlay or with RK 90 keycaps. Print and SMD versions available (suitable for automatic assembly). All products are RoHS compliant.

4

RACON

PCB KEY SWITCHES

RACON - TACTILE SWITCHES

Content

RACON 8 - Tactile switches	4 - 33
RACON 8 - Tactile switch, THT outward	4 - 37
RACON 8 - Tactile switch, THT inward	4 - 37
RACON 8 - Tactile switch, SMT gullwing (Z) terminals	4 - 38
RACON 12 - Tactile switches	4 - 39
RACON 12 - Tactile switch solder terminals for PCB, outward	4 - 43
RACON 12 - Tactile switch solder terminals for PCB, inward	4 - 43
RACON 12 - Tactile switch SMT gullwing (Z) terminals	4 - 44
RACON 12 V - Tactile switches with vertical adapter	4 - 45
RACON 12 V - Tactile switch with vertical adapter	4 - 46
RACON 12 i - Tactile switches	4 - 47
RACON 12 i - Tactile switch	4 - 48
RACON - Special accessories	4 - 49
Plunger round	4 - 49
Square plunger for membrane data entry system	4 - 51
RK 90 II - Key cap system for RACON 12 with individual sealing	4 - 52
RK 90 II - Sealing frame	4 - 53

RACON 8 Tactile switches

→ RACON 8 tactile switches offer an extremely high switching reliability while needing very little space. They can be arranged as single keys, in rows or key blocks.

When arranged under an overlay, RACON key switches should be combined with plungers.

The features at a glance:

- Suitable for the most common soldering methods
 - Wave soldering bath for THT versions
 - Reflow soldering for SMT version
 - Vapour phase soldering for SMT versions
 - Manual soldering
- SMT version suitable for processing with an automatic SMT assembly machine
- IMDS listed

You can download actual product information from our internet site www.rafi.de / Catalogues and Downloads

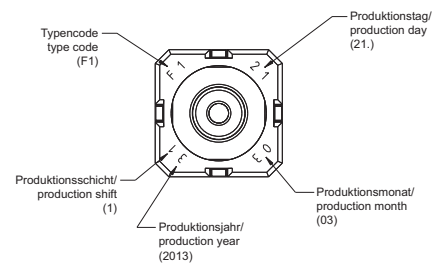



Technical Data

→ Dimensions	
Length of housing	8.4 mm
Width of housing	8.4 mm
Height of housing	see order block
→ Mechanical design	
Mounting	soldering
Terminals	see order block
Contact system	snap-action contact
Contact arrangement	1 NO
Contact materials	Au
Illumination	no
→ Mechanical characteristics	
Switching travel	0.34 ^{±0.1} mm
→ Electrical characteristics	
Rated voltage min.	0.02 V
Rated voltage max.	35 V
Rated current min.	0.01 mA
Rated current max.	100 mA
Rated power max. (ohmic load)	1 W
Contact resistance when new max.	100 mΩ
Insulation resistance	10 ⁹ Ω
→ Other specifications	
Ambient temp. operating min.	-40 °C
Ambient temp. operating max.	+90 °C
Resistance to environment	DIN EN 60068-2 -14,-30,-33 and -78
Operating life	1,000,000
Solderability / Solder heat resistance	see order block
Flammability of materials	UL 94 HB
Packing	see order block
Produkt type	see order block
ROHS compliant	yes
REACH compliant	yes

PCB KEY SWITCHES

RACON 8 - TACTILE SWITCHES

Accessories RACON 8 - Tactile switch

→ Description	Photo	Order no.	Additional accessories see page
Spacer, round, length 6.25 mm, red		5.30.759.034/0000	2 - 265, 4 - 97, 5 - 32
Plunger round		5.46.167.311/0209	4 - 49
RK 90 - Keycap body, for lenses 9 x 9 mm		5.55.103.265/1013	4 - 110

For other plungers, refer to the chapter „RACON special accessories“; for keycaps, refer to the chapter „RK 90“

RACON 8, Typical system assembly with plunger under overlay

THT terminal outward

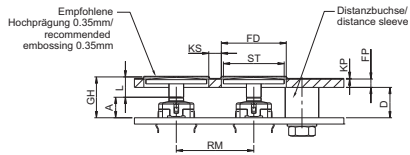

THT terminal inward

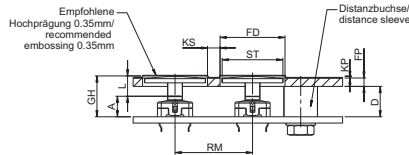

SMT gullwing terminal

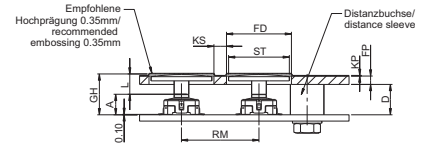

Variable Declaration

THT terminal inward and outward

SMT terminal

A	Height of key switch	$A = 4.90 \pm 0.1 \text{ mm}$	
D	Length of spacer $D = GH - KP - FP$		
FD	Front panel cut-out $FD = ST + 1 \text{ mm}$		
FP	Front panel thickness		
GH	Overall height	$GH = A + L$	$GH = A + L + 0.1 \text{ mm}$
KP	Thickness of overlay + embossing		
KS	Glue webs for overlay, min. 3 mm		
L	Length of plunger	$L = GH - A$	$L = GH - A - 0.1 \text{ mm}$
RM	Key grid		
ST	Diameter of plunger		

RACON 8, Standard system assembly

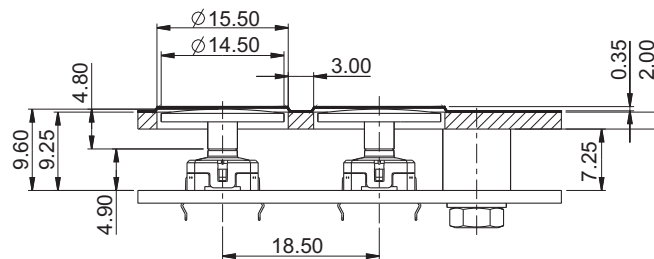

RACON 8, Lowest system assembly

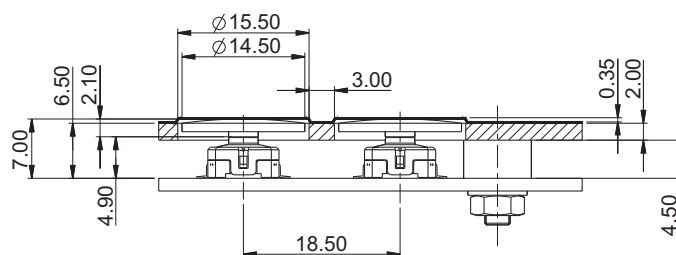

PCB KEY SWITCHES

RACON 8 - TACTILE SWITCHES

RACON 8, PCB hole pattern, smallest grid

THT terminal outward

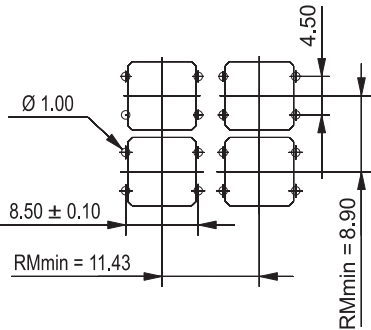

view on component side

THT terminal inward

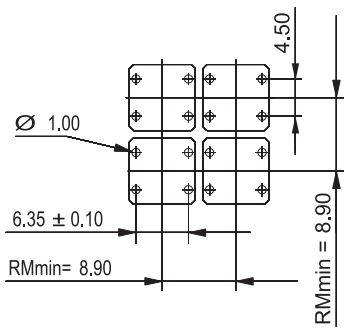

view on component side

SMT gullwing terminal

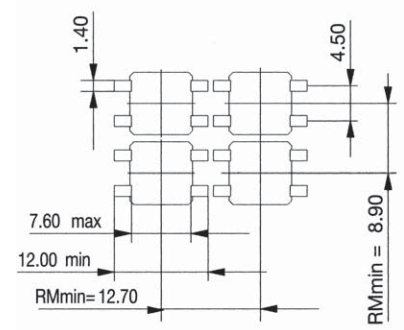

view on component side

RACON 8, SMT terminal, tape and reel

Circuit diagram RACON 8

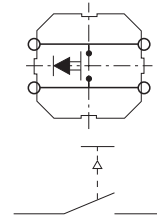
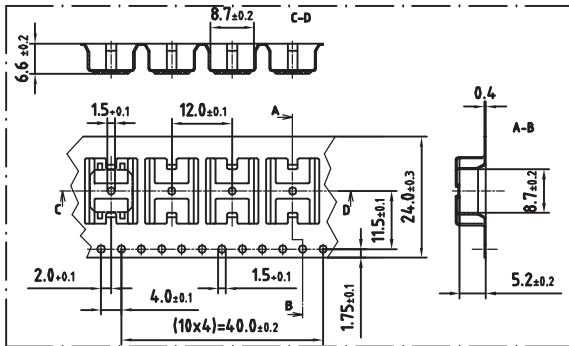

Switching symbols acc. to IEC 60 617 form X (twice interrupting)

4

Typical force travel diagram

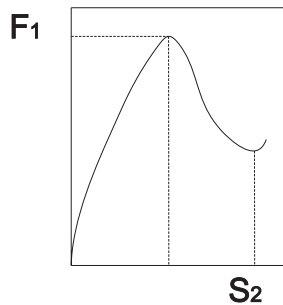

Operating force F1 and switching travel S2 see order block

RACON

RACON 8 Tactile switch, THT outward

Technical data see page 4 - 33

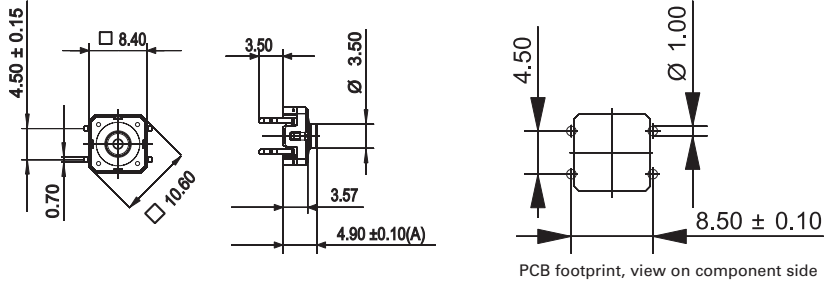

→ Produkt type	Terminals	Operating force	Solderability / Solder heat resistance	Packing	Order no.
A1	THT outward	3.3 ^{±0.6} N	DIN EN 60068-2-20	tubes à 60 pieces	1.14.100.501/0000

For keycaps refer to chapter „RK 90“; plungers see „RACON special accessories“

RACON 8 Tactile switch, THT inward

Technical data see page 4 - 33

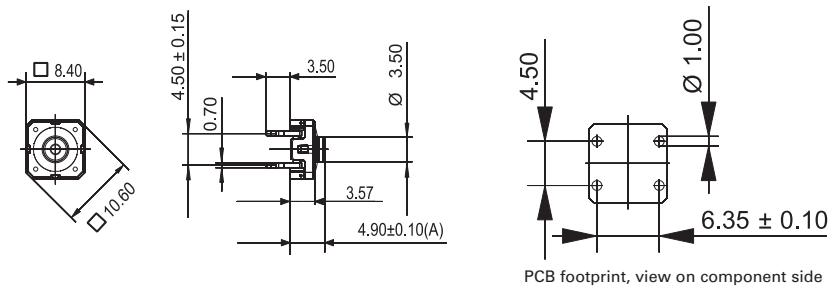

→ Produkt type	Terminals	Operating force	Solderability / Solder heat resistance	Packing	Order no.
B1	THT inward	3.3 ^{±0.6} N	DIN EN 60068-2-20	tubes à 60 pieces	1.14.100.502/0000

For keycaps refer to chapter „RK 90“; plungers see „RACON special accessories“

PCB KEY SWITCHES

RACON 8 - TACTILE SWITCHES



RACON 8 Tactile switch, SMT gullwing (Z) terminals

Technical data see page 4 - 33

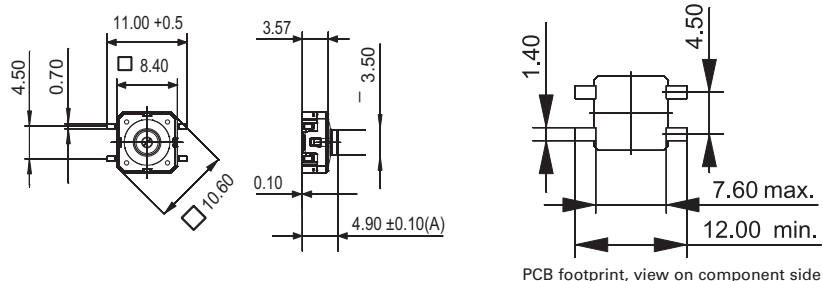

→ Produkt type	Operating force	Switching travel	Operating life	Packing	Solderability / Solder heat resistance	Order no.
C1	3.3 ^{±0.6} N	0.34 ^{±0.1} mm	1,000,000	tape and reel à 1000 pieces	DIN EN 60068-2-58	1.14.100.503/0000
C2	4.8 ^{±0.8} N	0.42 ^{±0.1} mm	1,000,000	tape and reel à 1000 pieces	DIN EN 60068-2-58	1.14.100.603/0000
C4	6.0 ^{±1.0} N	0.47 ^{±0.1} mm	50,000	tape and reel à 1000 pieces	DIN EN 60068-2-58	1.14.100.803/0000

For keycaps refer to chapter „RK 90“; plungers see „RACON special accessories“.

RACON 12 Tactile switches

→ RACON 12 tactile switches offer an extremely high switching reliability while needing very little space. They can be arranged as single keys, in rows or key blocks.

When arranged under an overlay, RACON key switches should be combined with plungers.

The features at a glance:

- Suitable for the most common soldering methods
 - Wave soldering bath for THT versions
 - Reflow soldering for SMT versions
 - Vapour phase soldering for SMT versions
 - Manual soldering
- SMT version suitable for processing with an automatic SMT assembly machine
- IMDS listed

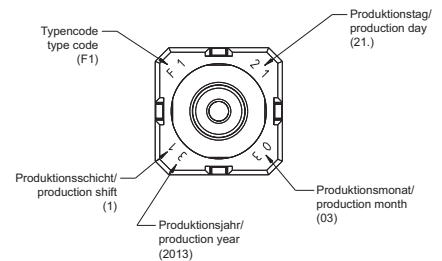

Technical Data

→ Dimensions

Length of housing	12 mm
Width of housing	12 mm
Overall height	see order block

→ Mechanical design

Mounting	soldering
Terminals	see order block
Contact system	snap-action contact
Contact arrangement	1 NO
Contact materials	Au
Illumination	no

→ Mechanical characteristics

Operating force	see order block
Switching travel	see order block

→ Electrical characteristics

Rated voltage min.	0.02 V
Rated voltage max.	35 V
Rated current min.	0.01 mA
Rated current max.	100 mA
Rated power max. (ohmic load)	1 W
Contact resistance when new max.	100 mΩ
Insulation resistance	10 ⁹ Ω





→ Other specifications

Ambient temp. operating min.	-40 °C
Ambient temp. operating max.	+90 °C
Resistance to environment	DIN EN 60068-2 -14,-30,-33 and -78
Operating life	see order block
Solderability / Solder heat resistance	see order block
Flammability of materials	UL 94 HB
Packing	see order block
Produkt code	see order block
ROHS compliant	yes
REACH compliant	yes

PCB KEY SWITCHES

RACON 12 - TACTILE SWITCHES

Accessories RACON 12 - Tactile switch

→ Description	Photo	Order no.	Additional accessories see page
Spacer, round, length 6.25 mm, red		5.30.759.034/0000	2 - 265, 4 - 97, 5 - 32
Square plunger for membrane data entry system		5.46.001.057/0209	4 - 51
Plunger round		5.46.168.050/0209	4 - 50
RK 90 - Keycap body, for lens 1 -module		5.55.103.030/1013	4 - 112

For other plungers, refer to the chapter „RACON special accessories“; for keycaps, refer to the chapter „RK 90“

RACON 12, Typical system assembly with plunger under overlay

THT terminal outward

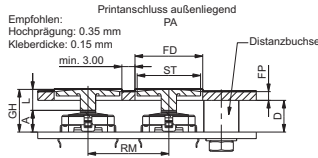

THT terminal inward

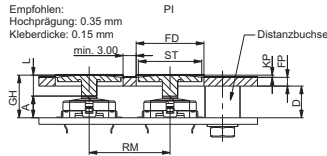

SMT gullwing terminal

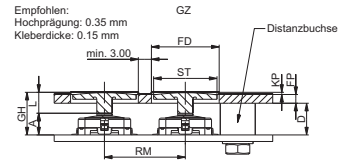

Variable Declaration

THT terminal inward and outward

SMT terminal

A	Height of key switch	$A = 4.90 \pm 0.1 \text{ mm}$
D	Length of spacer	$D = GH - KP - FP$
FD	Front panel cut-out	$FD = ST + 1 \text{ mm}$
FP	Front panel thickness	
GH	Overall height	$GH = A + L$
KP	Thickness of overlay + embossing	
L	Length of plunger	$L = GH - A$
RM	Key grid	
ST	Diameter of plunger	

RACON 12, Standard system assembly

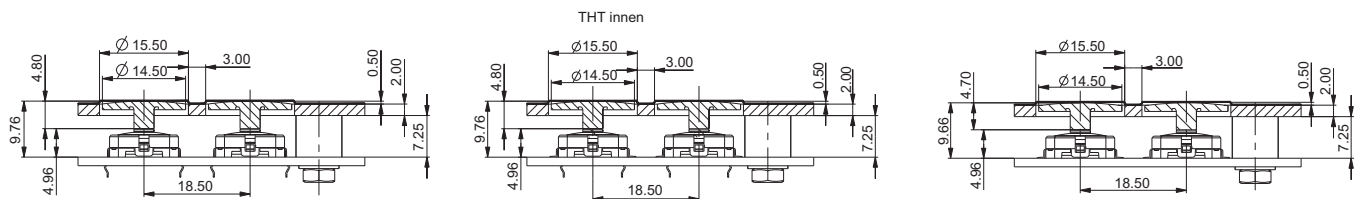

RACON 12, Lowest system assembly

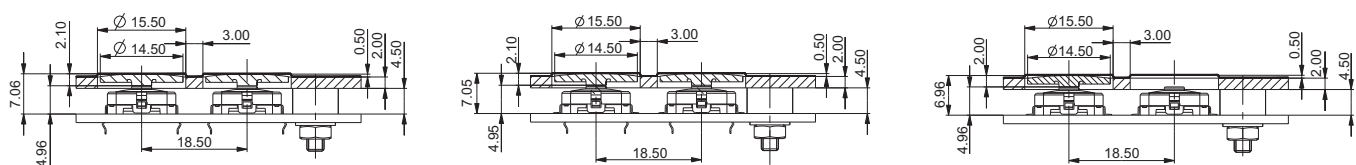

PCB KEY SWITCHES

RACON 12 - TACTILE SWITCHES

RACON 12, PCB hole pattern, smallest grid

THT terminal outward

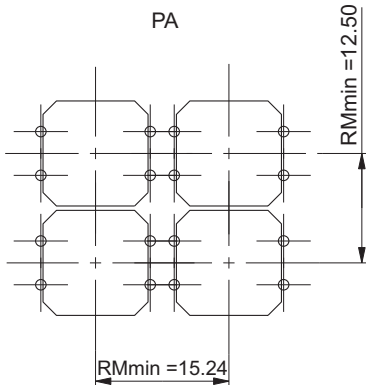

view on component side

THT terminal inward

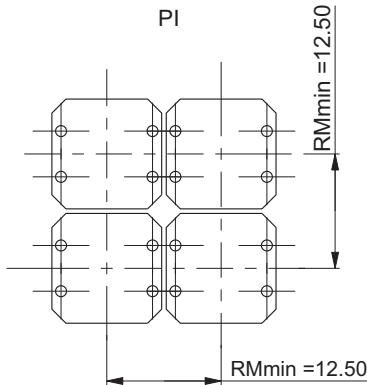

view on component side

SMT gullwing terminal

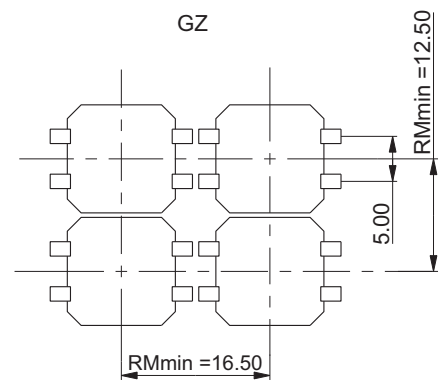

view on component side

RACON 12, SMT terminal, tape and reel

Circuit diagram RACON 12

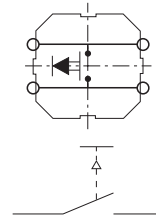
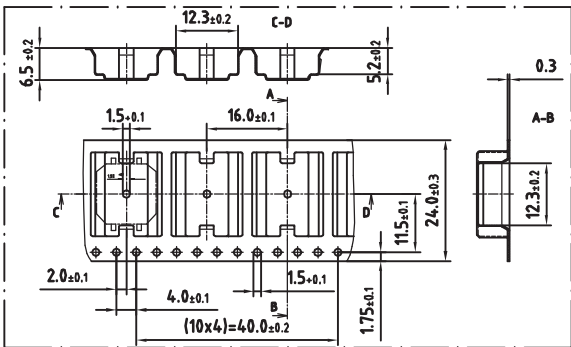

Switching symbols acc. to IEC 60 617 form X (twice interrupting)

4

Typical force travel diagram

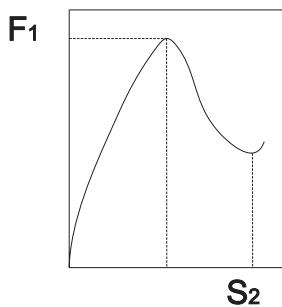

Operating force F1 and switching travel S2 see order block

RACON

RACON 12 Tactile switch solder terminals for PCB, outward

Technical data see page 4 - 39

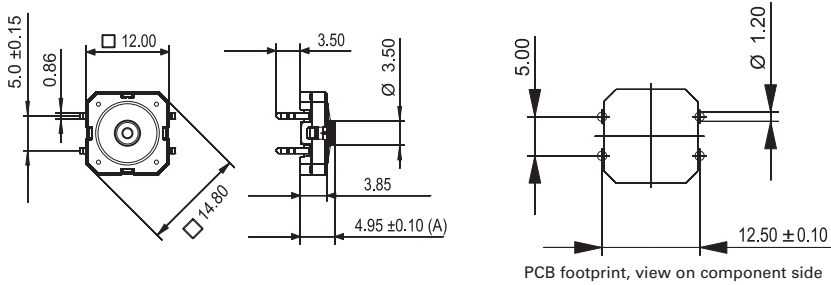

→ Produkt code	Operating force	Switching travel	Operating life	Solderability / Solder heat resistance	Packing	Order no.
A1	3.6 ^{±0.7} N	0.61 ^{±0.1} mm	1,000,000	DIN EN 60068-2-20	tubes à 45 pieces	1.14.001.501/0000

For keycaps refer to chapter „RK 90“, plungers see „RACON special accessories“.

RACON 12 Tactile switch solder terminals for PCB, inward

Technical data see page 4 - 39

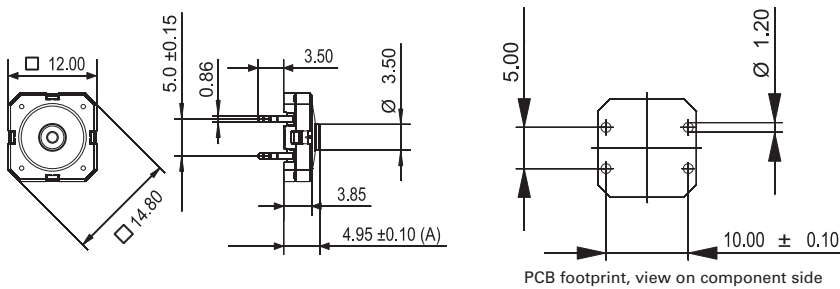

→ Produkt code	Operating force	Switching travel	Operating life	Solderability / Solder heat resistance	Packing	Order no.
B1	3.6 ^{±0.7} N	0.61 ^{±0.1} mm	1,000,000	DIN EN 60068-2-20	tubes à 45 pieces	1.14.001.502/0000

For keycaps refer to chapter „RK 90“, plungers see „RACON special accessories“.

PCB KEY SWITCHES

RACON 12 - TACTILE SWITCHES



RACON 12 Tactile switch SMT gullwing (Z) terminals

Technical data see page 4 - 39

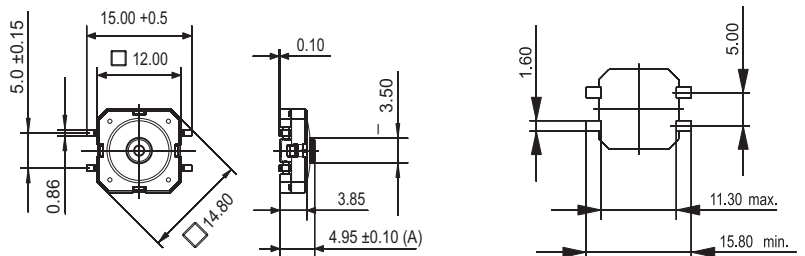

PCB footprint, view on component side

→ Produkt code	Operating force	Switching travel	Operating life	Solderability / Solder heat resistance	Packing	Order no.
C2	2.5 ^{±0.6} N	0.55 mm	1,000,000	DIN EN 60068-2-58	tape and reel à 750 pieces	1.14.001.603/0000
C1	3.6 ^{±0.7} N	0.61 ^{±0.1} mm	1,000,000	DIN EN 60068-2-58	tape and reel à 750 pieces	1.14.001.503/0000
C4	4.7 ^{±0.8} N	0.66 mm	1,000,000	DIN EN 60068-2-58	tape and reel à 750 pieces	1.14.001.803/0000
ZD	6.8 ^{±1.6} N	0.7 ^{±0.1} mm	1,000,000	DIN EN 60068-2-58	tape and reel à 750 pieces	1.14.001.916/0000
ZE	9.7 ^{±2.5} N	0.73 ^{±0.1} mm	65.000	DIN EN 60068-2-58	tape and reel à 750 pieces	1.14.001.920/0000

For keycaps refer to chapter „RK 90“; plungers see „RACON special accessories“

RACON 12 V Tactile switches with vertical adapter



→ The RACON 12 V version can be used, for example, for PC plug-in boards and for measurement and control engineering applications. The vertical mounting adapter (support element) absorbs the operating force so that the pressure on the soldered terminals is reduced. For this mounting arrangement, the key switch is provided with two horizontal terminals on one side.

Technical Data

→ Dimensions

Length	14.5 mm
Width	13.6 mm
Overall height	4.95 mm

→ Mechanical design

Mounting	soldering
Terminals	THT
Contact system	snap-action contact
Contact arrangement	1 NO
Contact materials	Au
Illumination	no

→ Mechanical characteristics

Operating force	3.6 ^{±0.7} N
Switching travel	0.61 ^{±0.1} mm

→ Electrical characteristics

Rated voltage min.	0.02 V
Rated voltage max.	35 V
Rated current min.	0.01 mA
Rated current max.	100 mA
Rated power max. (ohmic load)	1 W
Contact resistance when new max.	100 mΩ
Insulation resistance	10 ⁹ Ω

→ Other specifications

Ambient temp. operating min.	-40 °C
Ambient temp. operating max.	+80 °C
Storage temperature min.	-50 °C
Storage temperature max. (product)	+85 °C
Storage temperature max. (in tube)	+85 °C
Environmental resistance	acc. to IEC 60068-2-14, -30, -33 and -78
Operating life	1,000,000
Solderability / solder heat resistance	DIN EN 60068-2-20
Flammability of materials	UL 94 HB
Packing	in boxes à 100 pieces
Produkt code	F 1
ROHS compliant	yes
REACH compliant	yes

PCB KEY SWITCHES

RACON 12 V - TACTILE SWITCHES



RACON 12 V Tactile switch with vertical adapter

Technical data see page 4 - 45

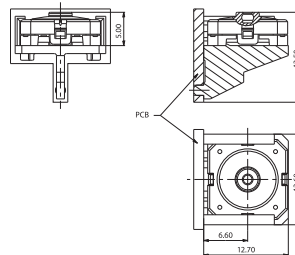

→ Produkt code	Terminals	Contact arrangement	Packing	Order no.
F 1	THT	1 NO	in boxes à 100 pieces	1.14.001.505/0000

Plungers for overall height of 6.5 mm may not be used.

RACON 12 I Tactile switches



→ Application note

Low-profile keyboards with RACON 12 i components should be designed with a grid spacing of 15.24 mm. With this grid, frame webs remain free between the individual keys. The overlay can be glued onto these frame webs; we recommend area embossing over the keys for the overlays. If our RK 90 system design is used, we recommend the 9 x 9 mm keycaps.

Technical Data

→ General information

Color of lens	see order block
Recommended key grid	15.24 x 15.24 mm
Key grid min.	12.5 x 12.5 mm

→ Dimensions

Length	11.35 mm
Width	11.35 mm
Overall height	9.7 mm

→ Mechanical design

Mounting	soldering
Terminals	THT
Contact system	snap-action contact
Contact arrangement	1 NO
Contact materials	Au
Illumination	fully illuminated 2 LED
LED color	see order block
LED type	standard 2 mm

→ Mechanical characteristics

Operating force	3.3 ^{±0.6} N
Switching travel	0.34 ^{±0.1} mm

→ Electrical characteristics

Rated voltage min.	0.02 V
Rated voltage max.	35 V
Rated current min.	0.01 mA
Rated current max.	100 mA
Rated power max. (ohmic load)	1 W
Contact resistance when new max.	100 mΩ
Dielectric strength AC min.	750 V
Insulation resistance	10 ⁹ Ω

→ Electrical characteristics of LED

LED rated current max. I _F at 25 °C	red/green: 30, yellow: 50 mA
LED current reduction beginning with 50 degree C	red: 0.5 mA/degree C, yellow 0.8 mA/degree C
LED wavelength typ.	red 639, green 510-535, yellow 590
LED forward voltage U _F at 20 mA	red: 1.8 V/20 mA, yellow: 1.9 V/20 mA
LED breakdown voltage U _R at 25 °C	min. 5 V/0.1 mA

→ Other specifications

Ambient temp. operating min.	-40 °C
Ambient temp. operating max.	+80 °C
Storage temperature min.	see order block
Storage temperature max. (product)	see order block
Storage temperature max. (in tube)	see order block
Environmental resistance	acc. to IEC 60068-2-14, -30, -33 and -78
Operating life	1,000,000
Solderability / solder heat resistance	DIN EN 60068-2-20
Flammability of materials	UL 94 HB
Packing	tubes à 45 pieces
ROHS compliant	yes
REACH compliant	yes

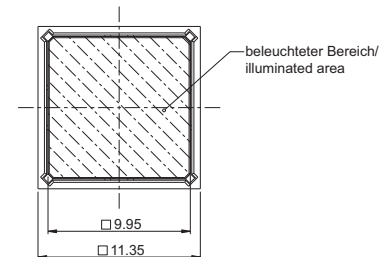
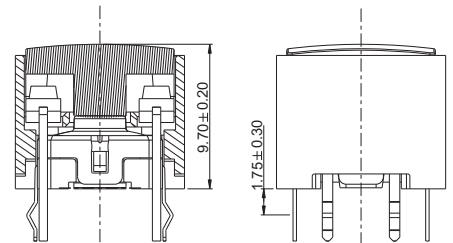

PCB KEY SWITCHES

RACON 12 I - TACTILE SWITCHES

RACON 12i Typical system assembly

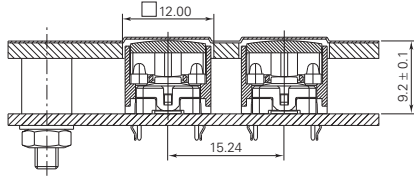

view on component side

Recommended area embossing:
0.35 mm at glue spacer thickness of 0.15 mm

RACON 12i PCB smallest grid

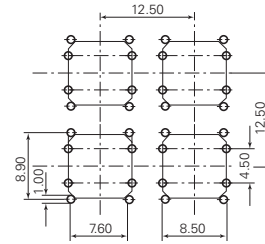

view on component side

LED hole patterns

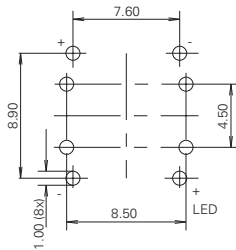

view on component side

RACON 12i Circuit diagram

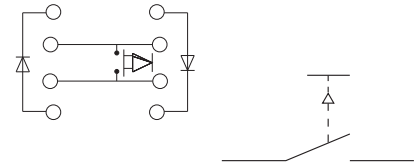

Switching symbols acc. to IEC 60 617 form X
(twice interrupting)

4



RACON 12 i Tactile switch

Technical data see page 4 - 47

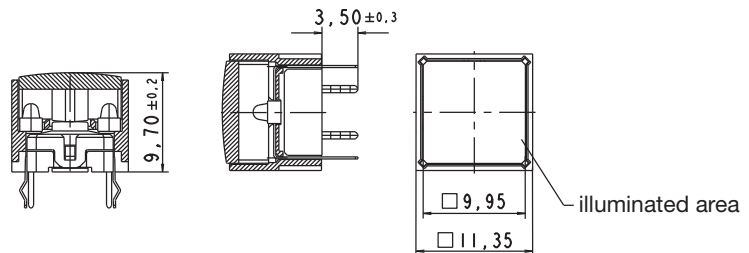

→ Terminals	Contact arrangement	Illumination	Color of lens	LED color	Order no.
THT	1 NO	fully illuminated 2 LED	red	red	1.14.001.551/0000
THT	1 NO	fully illuminated 2 LED	yellow	yellow	1.14.001.553/0000
THT	1 NO	fully illuminated 2 LED	orange	yellow	1.14.001.554/0000
THT	1 NO	fully illuminated 2 LED	green	green	1.14.001.552/0000

If keycaps are used we recommend RK 90 keycaps 9 x 9 mm.

RACON Special accessories

- GH = „L“ length of plunger + „A“ height of key switch (+ 0.1 mm for SMT versions)
Front panel cut-out = size of plunger + 1 mm



Technical Data

→ Dimensions

Length of plunger L	see order block
RACON version	see order block
Plunger diameter/size	see order block

→ Other specifications

ROHS compliant	yes
REACH compliant	yes

Plunger round

Technical data see page 4 - 49

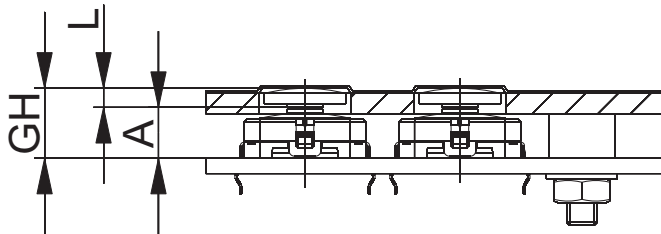

→ Plunger diameter/size	RACON version	Length of plunger L	Order no.
8 mm	RACON 8	1.4 mm	5.46.167.301/0209
8 mm	RACON 8	1.5 mm	5.46.167.102/0209
8 mm	RACON 8	1.6 mm	5.46.167.101/0209
8 mm	RACON 8/12	1.9 mm	5.46.167.090/0209
8 mm	RACON 8/12	2 mm	5.46.167.106/0209
8 mm	RACON 8/12	2.1 mm	5.46.167.107/0209
8 mm	RACON 8/12	4.6 mm	5.46.167.091/0209
8 mm	RACON 8/12	4.7 mm	5.46.167.311/0209
8 mm	RACON 8/12	4.8 mm	5.46.167.094/0209
8 mm	RACON 8/12	7.4 mm	5.46.167.092/0209
8 mm	RACON 8/12	7.5 mm	5.46.167.099/0209
8 mm	RACON 8/12	7.6 mm	5.46.167.096/0209

PCB KEY SWITCHES

RACON 8/12 - SPECIAL ACCESSORIES

– Table (continued) –
Plunger round

→ Plunger diameter/size	RACON version	Length of plunger L	Order no.
11.5 mm	RACON 8	1.4 mm	5.46.167.227/0209
11.5 mm	RACON 8	1.5 mm	5.46.167.061/0209
11.5 mm	RACON 8	1.6 mm	5.46.167.060/0209
11.5 mm	RACON 8/12	2 mm	5.46.167.067/0209
11.5 mm	RACON 8/12	2.1 mm	5.46.167.064/0209
11.5 mm	RACON 8/12	4.6 mm	5.46.167.043/0209
11.5 mm	RACON 8/12	4.7 mm	5.46.167.050/0209
11.5 mm	RACON 8/12	4.8 mm	5.46.167.047/0209
11.5 mm	RACON 8/12	7.5 mm	5.46.167.059/0209
11.5 mm	RACON 8/12	7.6 mm	5.46.167.058/0209
14.5 mm	RACON 8	1.4 mm	5.46.168.227/0209
14.5 mm	RACON 8	1.5 mm	5.46.168.061/0209
14.5 mm	RACON 8	1.6 mm	5.46.168.060/0209
14.5 mm	RACON 8/12	2 mm	5.46.168.067/0209
14.5 mm	RACON 8/12	2.1 mm	5.46.168.064/0209
14.5 mm	RACON 8/12	4.6 mm	5.46.168.043/0209
14.5 mm	RACON 8/12	4.7 mm	5.46.168.050/0209
14.5 mm	RACON 8/12	4.8 mm	5.46.168.047/0209
14.5 mm	RACON 8/12	7.4 mm	5.46.168.044/0209
14.5 mm	RACON 8/12	7.5 mm	5.46.168.059/0209
14.5 mm	RACON 8/12	7.6 mm	5.46.168.058/0209
19 mm	RACON 8	1.5 mm	5.46.169.061/0209
19 mm	RACON 8	1.6 mm	5.46.169.060/0209
19 mm	RACON 8/12	2 mm	5.46.169.067/0209
19 mm	RACON 8/12	2.1 mm	5.46.169.064/0209
19 mm	RACON 8/12	4.7 mm	5.46.169.050/0209
19 mm	RACON 8/12	4.8 mm	5.46.169.047/0209
19 mm	RACON 8/12	7.5 mm	5.46.169.059/0209
19 mm	RACON 8/12	7.6 mm	5.46.169.058/0209

Front panel cut-out = Plunger diameter + 1 mm.

4

RACON

Square plunger for membrane data entry system

Technical data see page 4 - 49

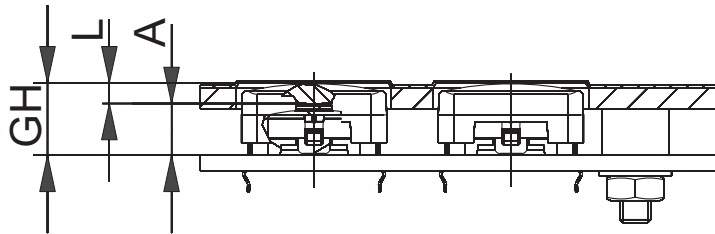

→ Plunger diameter/size	RACON version	Length of plunger L	Order no.
14 x 14 mm	RACON 12 SMT	2 mm	5.46.001.057/0209
14 x 14 mm	RACON 12 SMT	4.7 mm	5.46.001.058/0209
14 x 14 mm	RACON 12 SMT	7.5 mm	5.46.001.059/0209
14 x 14 mm	RACON 12THT	2.1 mm	5.46.001.064/0209
14 x 14 mm	RACON 12THT	4.8 mm	5.46.001.060/0209
14 x 14 mm	RACON 12THT	7.6 mm	5.46.001.063/0209

Front panel cut-out = 15 x 15 mm.

PCB KEY SWITCHES

RK 90 II, KEY CAP SYSTEM FOR RACON 12

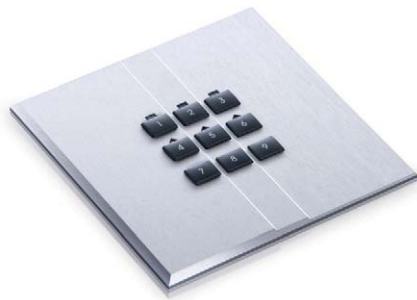

RK 90 II Key cap system for RACON 12 with individual sealing

Technical Data

→ General information

Thickness of front panel	3.00 mm
Light conductor	see order block
Key grid	min. 16.8 x 17.5 mm
Degree of protection	IP65 (DIN EN 60529)

→ Other specifications

ROHS compliant	yes
REACH compliant	yes

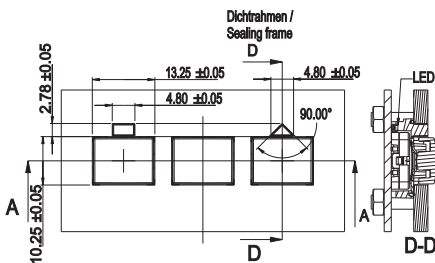

The key cap system RK 90 II has been developed especially for the tactile switch RACON 12. The lenses are snapped onto the sealing frame and then set onto the RACON 12 key switches. The PCB presses this units against the front panel, so they are sealed.

Two versions of the sealing frames are provided with light conductors, either in square or triangle form.

The lenses can be legended directly with laser. For bright letters (see picture) first white lenses are painted in dark, then the letters are cut out of the dark color with laser.

4

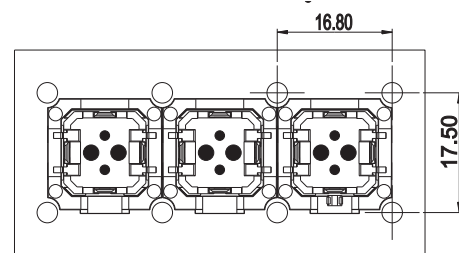
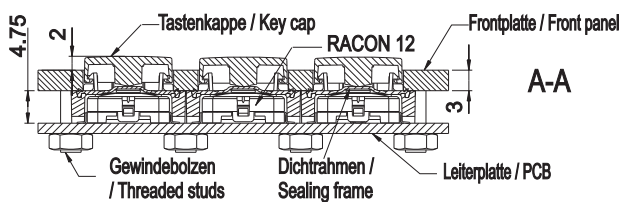

Kleinstes Raster / Minimum grid: 16.80 x 17.50

RACON

RK 90 II Sealing frame

Technical data see page 4 - 52



Sealing frame with square light conductor



→ Thickness of front panel	Light conductor	Order no.
3.00 mm	square	5.05.004.901/0000
3.00 mm	dreieckig	5.05.004.902/0000
3.00 mm	-	5.05.004.903/0000

Legended lenses on request.

Lenses:

- Lens RK 90 II, white: 5.46.654.192/0200
- Lens RK 90 II, red: 5.46.654.192/0300
- Lens RK 90 II, yellow: 5.46.654.192/0400
- Lens RK 90 II, green: 5.46.654.192/0500
- Lens RK 90 II, blue: 5.46.654.192/0600
- Lens RK 90 II, grey: 5.46.654.192/0700
- Lens RK 90 II, grey (varnished): 5.46.654.192/6032
- Lens RK 90 II, iron grey (varnished): 5.46.654.192/6033



RF

Tactile switches

RF 15 (15 x 15 mm) and RF 19 (19 x 19 mm) with distinct key click, for use under an overlay or with RK 90 keycaps. Can be fully illuminated. All products are RoHS compliant.

PCB KEY SWITCHES

RF - TACTILE SWITCHES

Content

RF 15 - Tactile switches	4 - 58
RF 15 - Tactile switch, non-illuminated	4 - 60
RF 15 - Tactile switch, fully illuminated with 2 LED	4 - 60
RF 15 - Tactile switch, 1 LED spot-illumination	4 - 61
RF 15 N - Tactile switches	4 - 62
RF 15 N - Tactile switch, non-illuminated	4 - 66
RF 15 R - Tactile switches	4 - 67
RF 15 R - Low tactile switch, non-illuminated	4 - 70
RF 15 R - High tactile switch, non-illuminated	4 - 70
RF 15 R - Low tactile switch, 1 LED spot-illumination	4 - 71
RF 15 R - High tactile switch, 1 LED spot-illumination	4 - 71
RF 15 H - Tactile switches	4 - 73
RF 15 H - Tactile switch, non-illuminated	4 - 76
RF 15 H - Tactile switch, fully illuminated	4 - 76
RF 15 - Signal indicators	4 - 78
RF 15 - Signal indicator, fully illuminated, 1 LED	4 - 80
RF 19 - Tactile switches	4 - 81
RF 19 - Tactile switch, non-illuminated	4 - 84
RF 19 - Tactile switch, fully illuminated with 2 LED	4 - 84
RF 19 - Tactile switch, 1 LED spot-illumination	4 - 85
RF 19 H - Tactile switches	4 - 86
RF 19 H - Tactile switch, non-illuminated	4 - 89
RF 19 H - Tactile switch, fully illuminated	4 - 89
RF 19 - Signal indicators	4 - 91
RF 19 - Signal indicator, 1/2 x 1-module	4 - 93
RF 19 - Signal indicator, 1/2 x 2-module	4 - 93
RF 19 - Signal indicator, 1 x 1-module	4 - 94
RF 19 - Signal indicator, 1 x 2-module	4 - 94
RF 15/19 - Special accessories	4 - 95
RF 15 N - Extension plunger, round head	4 - 95
RF 15 N - Extension plunger, round head, with recess for LED	4 - 96
RF 15 - Keycap, snap-on, for overall height 12.5 mm	4 - 96
Spacer, round	4 - 97
Spacer, triangular	4 - 98
RF 15 N - LED spacer	4 - 99

Specifications LED

LED brightness classes

LEDs are subject to production-related variations in brightness over which we have no control with the manufacturers. It is therefore not possible to arrange a delivery in a specific brightness class, and deviations accordingly do not constitute grounds for complaint regarding our products. The majority of the LEDs we use are delivered from

our suppliers in selected brightness classes. In this case, the brightness class is shown on a label on the switch's rack packaging. Where the lighting is required to have a uniform brightness – for aesthetic reasons, for example – this can be achieved in the system by means of the circuitry (with a series resistance, for example).

3 mm LED

(valid for 25 °C)	Red LED	Green LED	Yellow LED
Max. forward current I _F :	30 mA	30 mA	20 mA
Current reduction from: T ₀ = 50 °C:	approx 0.5 mA/°C	approx 0.5 mA/°C	approx 0.2 mA/°C
Wavelength typ:	635 nm	565 nm	586 nm
Forward voltage U _F /I _F typ:	2 V/10 mA	2 V/10 mA	2 V/10 mA
Reverse voltage U _R /I _F typ:	5 V/100 µA min.	5 V/100 µA min.	5 V/100 µA min.
Ambient temperature, operating:	- 20 °C ... + 80 °C	- 20 °C ... + 80 °C	- 20 °C ... + 80 °C

	Blue LED	White LED	Green LED superbright
Max. forward current I _F :	20 mA	25 mA	30 mA
Current reduction from: T ₀ = 50 °C:	approx 0.6 mA/°C	-	-
Wavelength typ:	470 nm	-	510-545 nm
Forward voltage U _F /I _F typ:	2.7 V/10 mA	3.6 V/20 mA	3.5 V/20 mA
Reverse voltage U _R /I _F typ:	5V/100 µA min.	-	-
Ambient temperature, operating:	- 20 °C ... + 80 °C	- 20 °C ... + 80 °C	-30 °C ... + 100 °C

2 mm LED (full illumination of RF 15/19)

(valid for 25 °C)	Red LED	Green LED	Yellow LED
Max. forward current I _F :	30 mA	30 mA	50 mA
Current reduction from: T ₀ = 50 °C:	0.5 mA/°C	0.5 mA/°C	0.8 mA/°C
Light current I _V /I _F typ:	-	-	250 mIm/20 mA
Wavelength typ:	637 nm	569 nm	590 nm
Forward voltage U _F /I _F typ:	1.8 V/20 mA	2.1 V/10 mA	1.9 V/20 mA
Reverse voltage U _R /I _F typ:	5 V/100 µA min.	5 V/100 µA min.	5 V/100 µA min.
Ambient temperature, operating:	- 55 °C ... + 100 °C	- 40 °C ... + 100 °C	-40 °C ... + 100 °C

	Blue LED	Multi-color LED
Max. forward current I _F :	30 mA	30 mA
Current reduction from: T ₀ = 50 °C:	-	approx 0.6 mA/°C
Light current I _V /I _F typ:	-	-
Wavelength typ:	464-485 nm	635/565 nm
Forward voltage U _F /I _F typ:	3.6 V/20 mA	2 V/10 mA
Reverse voltage U _R /I _F typ:	-	-
Ambient temperature, operating:	- 20 °C ... + 80 °C	- 20 °C ... + 80 °C

Calculating the series resistor:

$$R_V = \frac{U_B - U_F}{I_F}$$

Rated power of series:

$$P_V = I_F^2 \times R_V$$

Example for 5 Volt:

$$R_V = \frac{5V - 2,0V}{0,02 A} = 150 \Omega (= \text{standard value})$$

PCB KEY SWITCHES

RF 15 - TACTILE SWITCHES



RF 15 Tactile switches

- Low-profile keyboards with RF 15 components should be designed with a 19.05 mm grid. With this grid, frame webs remain free between the individual keys. The overlay can be glued onto these frame webs; we recommend area embossing over the keys for the overlays.

Technical Data

→ General information

Color of lens	see order block
Recommended key grid	19.05 mm

→ Dimensions

Length	15 mm
Width	15 mm
Overall height	9.7 mm

→ Mechanical design

Mounting	soldering in PCB
Terminals	THT
Contact system	snap-action contact
Contact arrangement	1 NO
Contact materials	see order block
Illumination	see order block
LED color	see order block
LED type	see order block

→ Mechanical characteristics

Operating force max.	2.9 ^{+0.6} N
Switching travel	0.5 ^{+0.2} mm
Robustness max.	with through-plated PCB 100 N

→ Electrical characteristics

Rated voltage min.	Au: 0.02 V, Ag: 3 V
Rated voltage max.	35 V
Rated current min.	Au: 0.01 mA, Ag: 0.1 mA
Rated current max.	Au: 100 mA, Ag: 250 mA
Rated power max. (ohmic load)	Au: 2 W, Ag: 12.5 W
Contact resistance when new max.	100 mΩ
Insulation resistance	10 ⁹ Ω

→ Other specifications

Ambient temp. operating min.	-25 °C
Ambient temp. operating max.	+70 °C
Environmental resistance	acc. to IEC 60068-2-14, -30, -33 and -78
Operating life min. (operations)	1,000,000
Solderability / solder heat resistance	according to DIN EN 60068-2-20
Wave soldering	260 °C max.
Manual soldering	350 °C / 5 sec. max.
ROHS compliant	yes
REACH compliant	yes

PCB KEY SWITCHES

RF 15 - TACTILE SWITCHES

Typical force travel diagram

Actuating characteristics
Force travel diagram

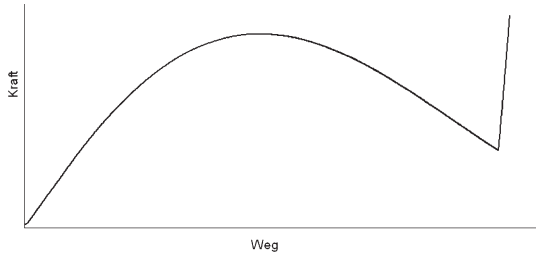

Circuit diagrams RF 15

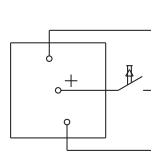

Tactile switch, non-illuminated

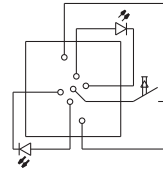

Tactile switch, fully-illuminated

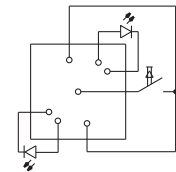

Tactile switch, spot-illuminated

System assembly RF 15

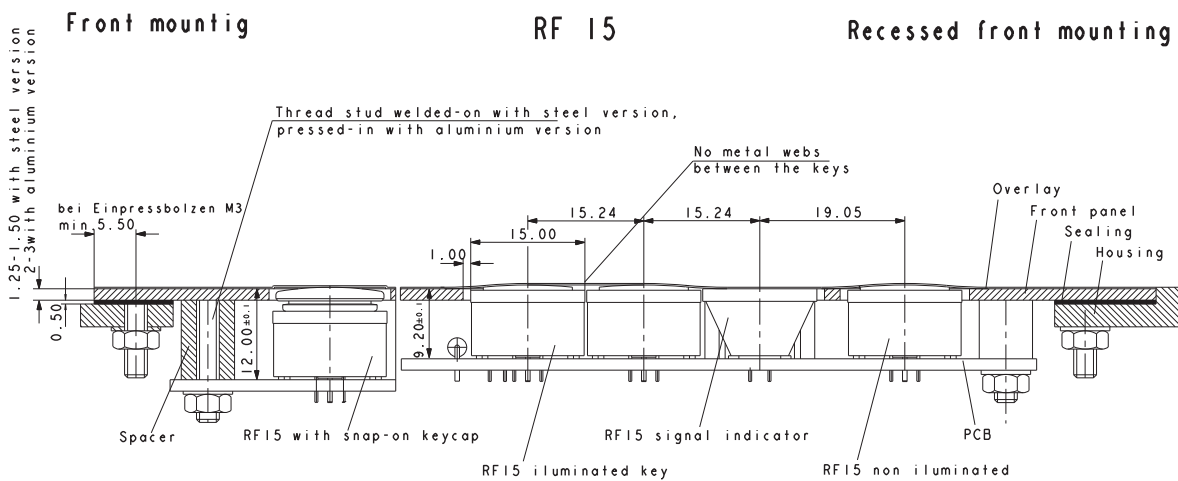

4

PCB hole patterns RF 15

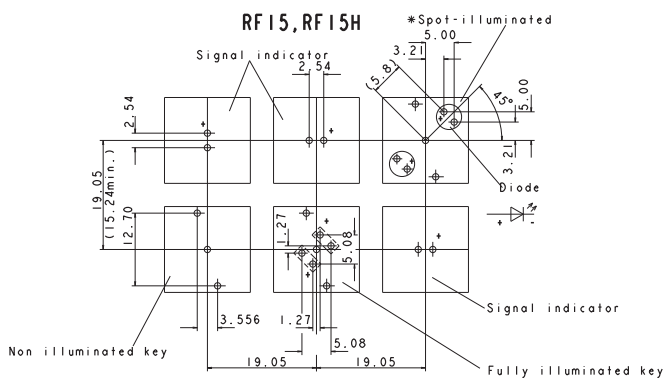

Hole patterns front panel RF 15

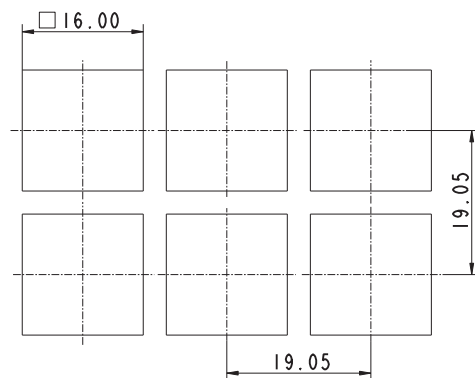

RF

View on component side, all hole diameters 1.1 ± 0.1 mm

PCB KEY SWITCHES

RF 15 - TACTILE SWITCHES



RF 15 Tactile switch, non-illuminated

Technical data see page 4 - 58

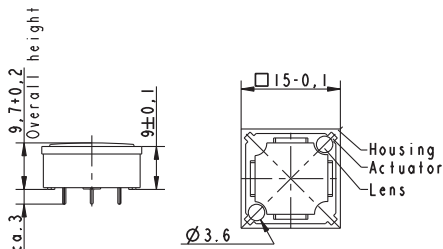

→ Contact materials	Illumination	Color of lens	LED color	LED type	Order no.
Au	not illuminated	transparent	-	-	3.14.100.001/0000
Ag	not illuminated	transparent	-	-	3.14.100.006/0000

For keycaps, refer to chapter accessories and system RK 90.

If exchangeable legends are required, or if an overall height of 12.5 mm is required, a keycap can be mounted on the non-illuminated keys. The keycap legend is visible through a window in the overlay. You can change the legend by replacing the keycap.



RF 15 Tactile switch, fully illuminated with 2 LED

Technical data see page 4 - 58

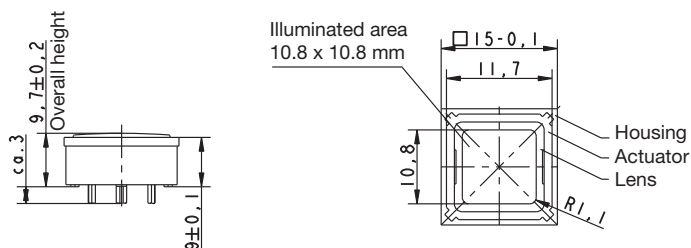

→ Contact materials	Illumination	Color of lens	LED color	LED type	Order no.
Au	fully illuminated 2 LED	red	red	2 mm	3.14.200.011/0000
Au	fully illuminated 2 LED	yellow	yellow	2 mm	3.14.200.013/0000
Au	fully illuminated 2 LED	orange	yellow	2 mm	3.14.200.014/0000
Au	fully illuminated 2 LED	green	green	2 mm	3.14.200.012/0000
Au	fully illuminated 2 LED	blue	blue	2 mm	3.14.200.015/0000
Ag	fully illuminated 2 LED	red	red	2 mm	3.14.200.021/0000
Ag	fully illuminated 2 LED	yellow	yellow	2 mm	3.14.200.023/0000
Ag	fully illuminated 2 LED	orange	yellow	2 mm	3.14.200.024/0000

4

RF

– Table (continued) –
RF 15 - Tactile switch, fully illuminated with 2 LED

→ Contact materials	Illumination	Color of lens	LED color	LED type	Order no.
Ag	fully illuminated 2 LED	green	green	2 mm	3.14.200.022/0000
Ag	fully illuminated 2 LED	blue	blue	2 mm	3.14.200.025/0000

For keycaps, refer to RK 90 system design.

Technical data of LED see separate page at the beginning of this chapter.

RF 15 Tactile switch, 1 LED spot-illumination

Technical data see page 4 - 58

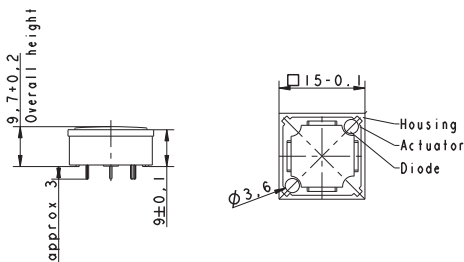

→ Contact materials	Illumination	Color of lens	LED color	LED type	Order no.
Au	spot illumination 1 LED	transparent	red	3 mm	3.14.100.031/0000
Au	spot illumination 1 LED	transparent	yellow	3 mm	3.14.100.033/0000
Au	spot illumination 1 LED	transparent	green	3 mm	3.14.100.032/0000
Au	spot illumination 1 LED	opaque white	blue	3 mm	3.14.100.030/0000
Ag	spot illumination 1 LED	transparent	red	3 mm	3.14.100.041/0000
Ag	spot illumination 1 LED	transparent	yellow	3 mm	3.14.100.043/0000
Ag	spot illumination 1 LED	transparent	green	3 mm	3.14.100.042/0000
Ag	spot illumination 1 LED	transparent	blue	3 mm	3.14.100.040/0000

Double-spot LED illumination available on request

Technical data of LED see separate page at the beginning of this chapter.

PCB KEY SWITCHES

RF 15 N - TACTILE SWITCHES



RF 15 N Tactile switches

→ The RF 15N key switch provides a minimum overall height of 6.2 mm. The overall height can be varied by extension plungers which are inserted into the cross-like notches on the actuator tops.

LEDs can only be arranged separately next to the key switches up to an overall height of 10 mm (i.e. without plunger or with small plunger).

Key switches with overall heights of 12 mm or more can be provided with a maximum of 2 LEDs which are inserted into the recesses of the key switch housing. LEDs of key switches with overall heights of 12.5 mm or more should be placed onto LED spacers in order to obtain satisfactory illumination.



Technical Data

→ General information

Color of lens	see order block
Recommended key grid	19.05 mm

→ Dimensions

Length	15 mm
Width	15 mm
Overall height	6.2 mm

→ Mechanical design

Mounting	soldering in PCB
Terminals	THT
Contact system	snap-action contact
Contact arrangement	1 NO
Contact materials	see order block
Illumination	external 3 mm LED possible if height more than 12 mm

→ Mechanical characteristics

Operating force max.	2.9 ^{±0.6} N
Switching travel	0.5 ^{±0.2} mm
Robustness max.	100 with through-plated PCB N

→ Electrical characteristics

Rated voltage min.	Au: 0.02 V, Ag: 3 V
Rated voltage max.	35 V
Rated current min.	Au: 0.01 mA, Ag: 0.1 mA
Rated current max.	Au: 100 mA, Ag: 250 mA
Rated power max. (ohmic load)	Au: 2 W, Ag: 12.5 W
Contact resistance when new max.	100 mΩ
Insulation resistance	10 ⁹ Ω

→ Other specifications

Ambient temp. operating min.	-25 °C
Ambient temp. operating max.	+70 °C
Storage temperature max. (in tube)	+50 °C
Environmental resistance	acc. to IEC 60068-2-14, -30, -33 and -78
Operating life min. (operations)	1,000,000
Solderability / solder heat resistance	according to DIN EN 60068-2-20
Wave soldering	260 °C max.
Manual soldering	350 °C / 5 sec. max.
ROHS compliant	yes
REACH compliant	yes





4

RF

PCB KEY SWITCHES

RF 15 N - TACTILE SWITCHES

Accessories RF 15 N - Tactile switch

→ Description	Photo	Order no.	Additional accessories see page
RF 15 N - LED spacer \varnothing 5 mm, spacing length 2.2 mm, light grey, for use with overall height of 12.5 mm		5.30.109.010/0756	4 - 99
RF 15 N - Extension plunger, \varnothing 10 mm, overall height 22.5 mm		5.46.011.028/0710	4 - 95
RF 15 N - Extension plunger, \varnothing 15 mm, overall height 22.5 mm		5.46.017.028/0710	4 - 96
RF 15 N - Extension plunger, \varnothing 15 mm, overall height 22.5 mm		5.46.017.029/0710	-

PCB KEY SWITCHES

RF 15 N - TACTILE SWITCHES

Typical force travel diagram

Actuating characteristics
Force travel diagram

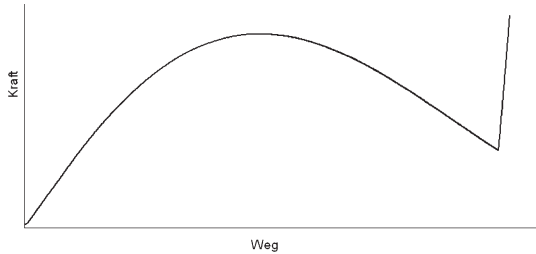

Circuit diagrams RF 15 N

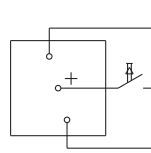

Tactile switch, non-illuminated

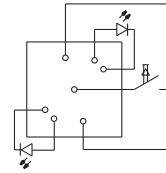

Tactile switch, spot-illuminated

Dimensional drawing RF 15 N

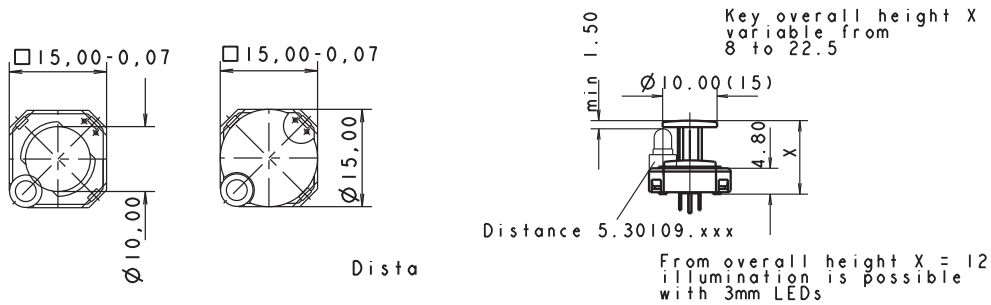

4

RF

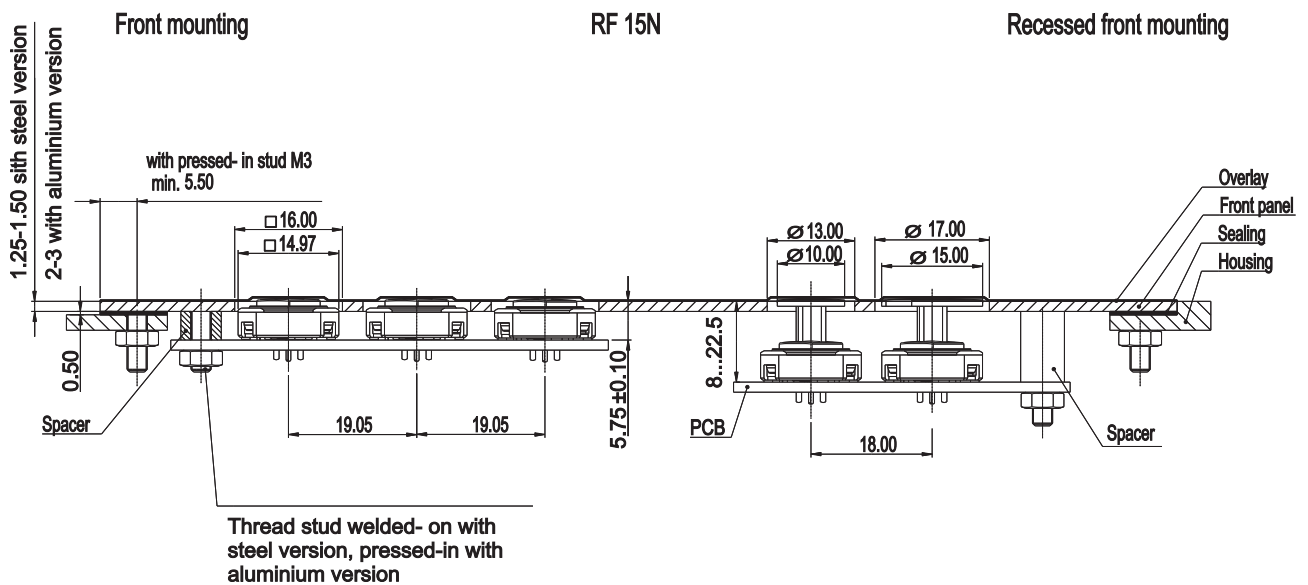

Hole patterns front panel RF 15 N

RF 15 N without plunger

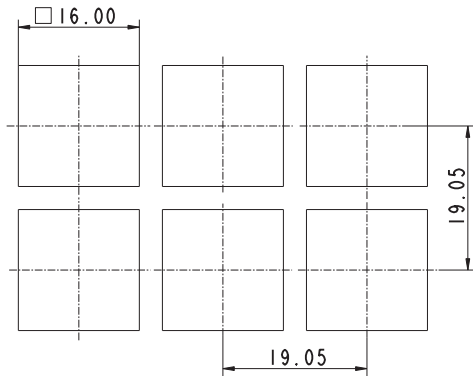

RF 15 N with plunger \varnothing 10 mm, not illuminated

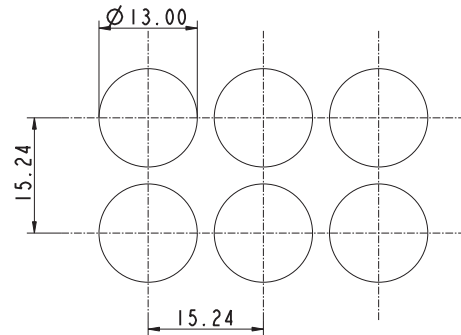

RF 15 N with plunger \varnothing 10 mm, illuminated

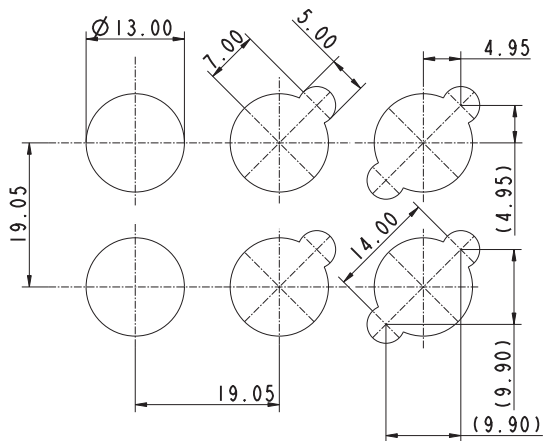

RF 15 N with plunger \varnothing 15 mm, illuminated

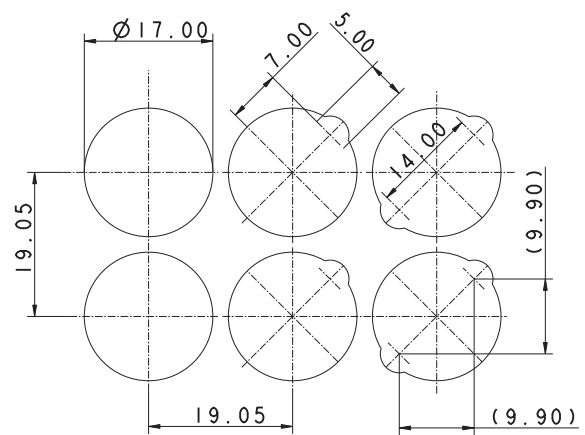

PCB hole patterns RF 15 N

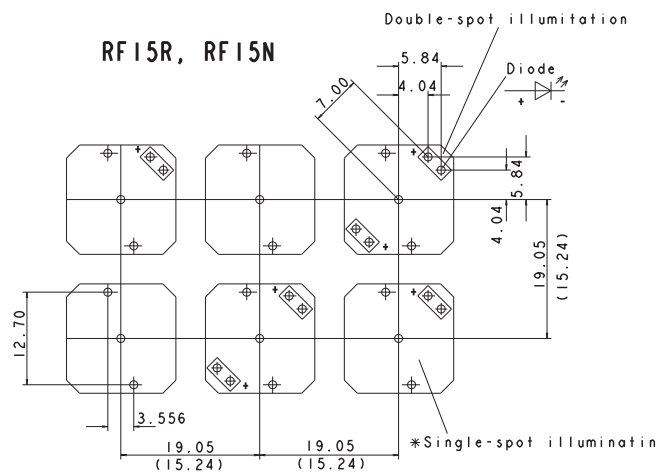

View on component side,
all hole diameters $1.1^{+0.1}$ mm
PCB layout switch 1/400" grid

PCB KEY SWITCHES

RF 15 N - TACTILE SWITCHES



RF 15 N Tactile switch, non-illuminated

Technical data see page 4 - 62

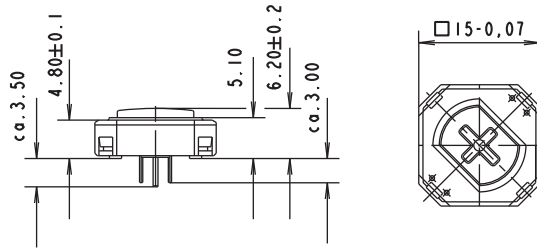

→ Contact materials	Illumination	Recommended key grid	Overall height	Order no.
Au	external 3 mm LED possible if height more than 12 mm	19.05 mm	6.2 mm	3.14.100.601/0000
Ag	external 3 mm LED possible if height more than 12 mm	19.05 mm	6.2 mm	3.14.100.606/0000

For keycaps, refer to RK 90 system design.
Double-spot LED illumination available on request.

RF 15 R Tactile switches

→ The round actuator of the RF 15 R key switch requires round front panel cut-outs. These make it possible to use a narrow keyboard grid of only 15.24 mm with sufficiently large frame webs between the individual keys. We recommend area embossing over the actuators for the overlay.



Technical Data

→ General information

Recommended key grid	15.24 mm
----------------------	----------

→ Dimensions

Length	15 mm
Width	15 mm
Overall height	see order block

→ Mechanical design

Mounting	soldering in PCB
Terminals	THT
Contact system	snap-action contact
Contact arrangement	1 NO
Contact materials	see order block
Illumination	see order block
LED color	see order block
LED type	see order block

→ Mechanical characteristics

Operating force max.	2.9 ^{±0.6} N
Switching travel	0.5 ^{+0.2} mm
Robustness max.	with through-plated PCB 100 N

→ Electrical characteristics

Rated voltage min.	Au: 0.02 V, Ag: 3 V
Rated voltage max.	35 V
Rated current min.	Au: 0.01 mA, Ag: 0.1 mA
Rated current max.	Au: 100 mA, Ag: 250 mA
Rated power max. (ohmic load)	Au: 2 W, Ag: 12.5 W
Contact resistance when new max.	100 mΩ
Insulation resistance	10 ⁹ Ω

→ Other specifications

Ambient temp. operating min.	-25 °C
Ambient temp. operating max.	+70 °C
Environmental resistance	acc. to IEC 60068-2-14, -30, -33 and -78
Operating life min. (operations)	1,000,000
Solderability / solder heat resistance	according to DIN EN 60068-2-20
Wave soldering	260 °C max.
Manual soldering	350 °C / 5 sec. max.
ROHS compliant	yes
REACH compliant	yes



PCB KEY SWITCHES

RF 15 R LOW - TACTILE SWITCHES

Typical force travel diagram

Actuating characteristics
Force travel diagram

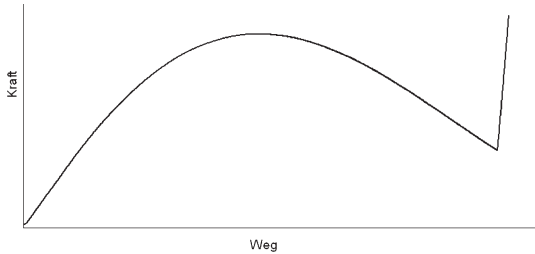

Circuit diagrams RF 15 R

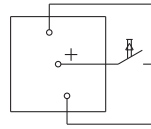

Tactile switch, non-illuminated

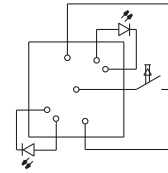

Tactile switch, spot-illuminated

Dimensional drawing RF 15 R

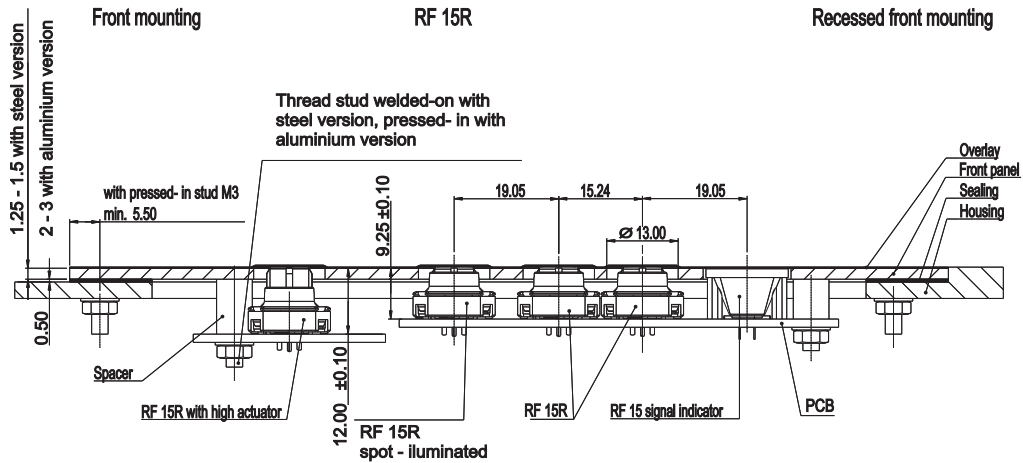

4

PCB hole patterns RF 15 R

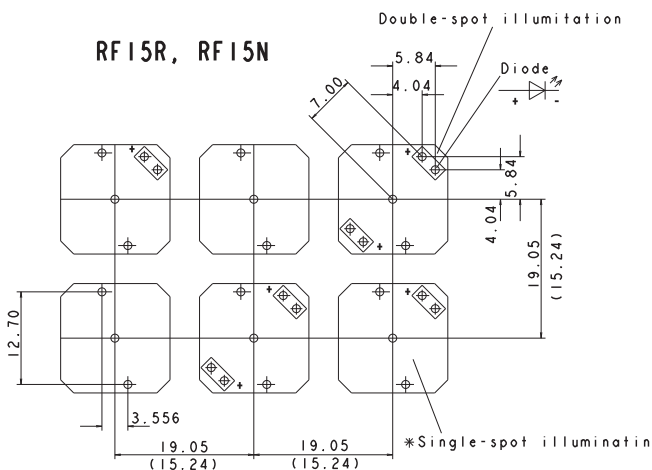

View on component side,
all hole diameters 1.1 ± 0.1 mm
PCB layout switch 1/400" grid

PCB KEY SWITCHES

RF 15 R LOW - TACTILE SWITCHES

Hole patterns front panel RF 15 R

RF 15 R, not illuminated

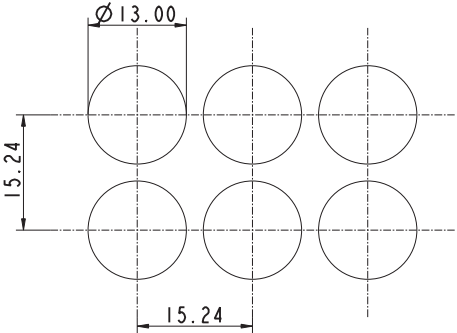

RF 15 R, illuminated

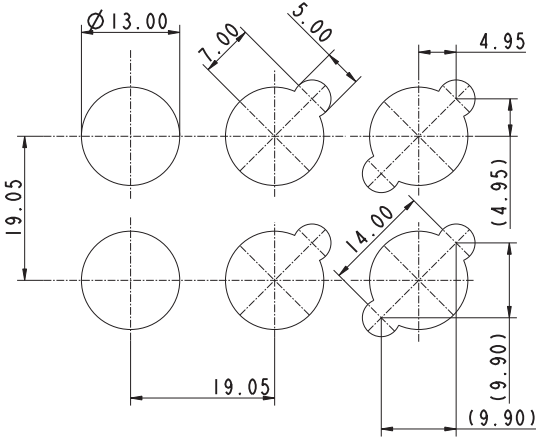

PCB KEY SWITCHES

RF 15 R LOW - TACTILE SWITCHES



RF 15 R Low tactile switch, non-illuminated

Technical data see page 4 - 67

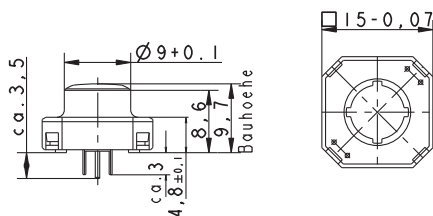

→ Contact materials	Overall height	Illumination	LED type	LED color	Order no.
Au	9.7 mm	not illuminated	-	-	3.14.100.501/0000
Ag	9.7 mm	not illuminated	-	-	3.14.100.506/0000



RF 15 R High tactile switch, non-illuminated

Technical data see page 4 - 67

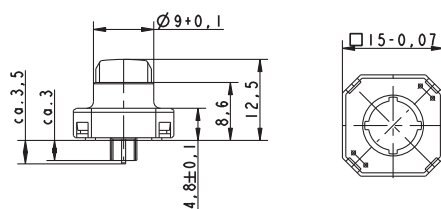

→ Contact materials	Overall height	Illumination	LED type	LED color	Order no.
Au	12.5 mm	not illuminated	-	-	3.14.100.801/0000
Ag	12.5 mm	not illuminated	-	-	3.14.100.806/0000

4

RF

RF 15 R Low tactile switch, 1 LED spot-illumination

Technical data see page 4 - 67

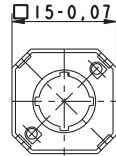
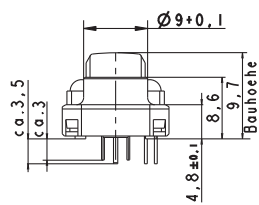

→ Contact materials	Overall height	Illumination	LED type	LED color	Order no.
Au	9.7 mm	spot illumination 1 LED	2 mm	red	3.14.100.531/0000
Au	9.7 mm	spot illumination 1 LED	2 mm	yellow	3.14.100.533/0000
Au	9.7 mm	spot illumination 1 LED	2 mm	green	3.14.100.532/0000
Ag	9.7 mm	spot illumination 1 LED	2 mm	red	3.14.100.541/0000
Ag	9.7 mm	spot illumination 1 LED	2 mm	yellow	3.14.100.543/0000
Ag	9.7 mm	spot illumination 1 LED	2 mm	green	3.14.100.542/0000

Versions with 2 LEDs available on request.

Technical data of LED see separate page at the beginning of this chapter.

RF 15 R High tactile switch, 1 LED spot-illumination

Technical data see page 4 - 67

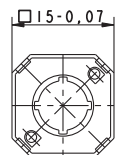
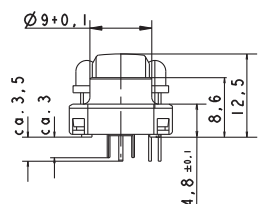

→ Contact materials	Overall height	Illumination	LED type	LED color	Order no.
Au	12.5 mm	spot illumination 1 LED	3 mm	red	3.14.100.831/0000
Au	12.5 mm	spot illumination 1 LED	3 mm	yellow	3.14.100.833/0000
Au	12.5 mm	spot illumination 1 LED	3 mm	green	3.14.100.832/0000

PCB KEY SWITCHES

RF 15 R LOW - TACTILE SWITCHES

– Table (continued) –

RF 15 R - High tactile switch, 1 LED spot-illumination

→ Contact materials	Overall height	Illumination	LED type	LED color	Order no.
Au	12.5 mm	spot illumination 1 LED	3 mm	blue	3.14.100.830/0000

Versions with 2 LEDs available on request.

Technical data of LED see separate page at the beginning of the chapter.

RF 15 H Tactile switches

→ Application notes:

The RF 15 H key has an overall height of 12.5 mm and can be fully illuminated. When designing membrane keyboards, we recommend using a key grid of at least 20 mm and a 0.13 mm overlay with area embossing over the keys.

You can use the O-ring (accessory) to block the key and use it as an indicator field or blank spaceholder.



Technical Data

→ General information

Color of lens	see order block
Recommended key grid	20 mm

→ Dimensions

Length	15 mm
Width	15 mm
Overall height	12.5 mm

→ Mechanical design

Mounting	soldering in PCB
Terminals	THT
Contact system	snap-action contact
Contact arrangement	1 NO
Contact materials	see order block
Illumination	see order block
LED color	see order block
LED type	see order block

→ Mechanical characteristics

Operating force max.	2.9 ^{+0.6} N
Switching travel	0.5 ^{+0.2} mm
Robustness max.	with through-plated PCB 100 N

→ Electrical characteristics

Rated voltage min.	Au: 0.02 V, Ag: 3 V
Rated voltage max.	35 V
Rated current min.	Au: 0.01 mA, Ag: 0.1 mA
Rated current max.	Au: 100 mA, Ag: 250 mA
Rated power max. (ohmic load)	Au: 2 W, Ag: 12.5 W
Contact resistance when new max.	100 mΩ
Insulation resistance	10 ⁹ Ω

→ Other specifications

Ambient temp. operating min.	-25 °C
Ambient temp. operating max.	+70 °C
Environmental resistance	acc. to IEC 60068-2-14, -30, -33 and -78
Operating life min. (operations)	1,000,000
Solderability / solder heat resistance	according to DIN EN 60068-2-20
Wave soldering	260 °C max.
Manual soldering	350 °C / 5 sec. max.
ROHS compliant	yes
REACH compliant	yes



PCB KEY SWITCHES

RF 15 H - TACTILE SWITCHES

Accessories RF 15 H - Tactile switch

→ Description	Photo	Order no.	Additional accessories see page
O-ring, black, 16.0 x 1, for blocking RF 19H keys		5.30.125.007/0100	5 - 31

4

RF

PCB KEY SWITCHES

RF 15 H - TACTILE SWITCHES

Typical force travel diagram RF 15 H

Actuating characteristics
Force travel diagram

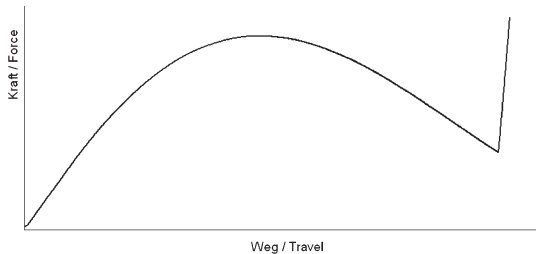

Curcuit diagram RF 15 H

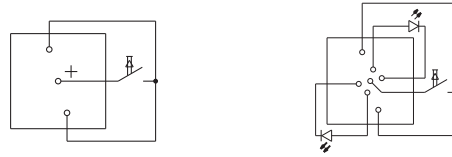

Tactile switch,
non-illuminated

Tactile switch,
fully-illuminated

Dimensional drawing RF 15 H

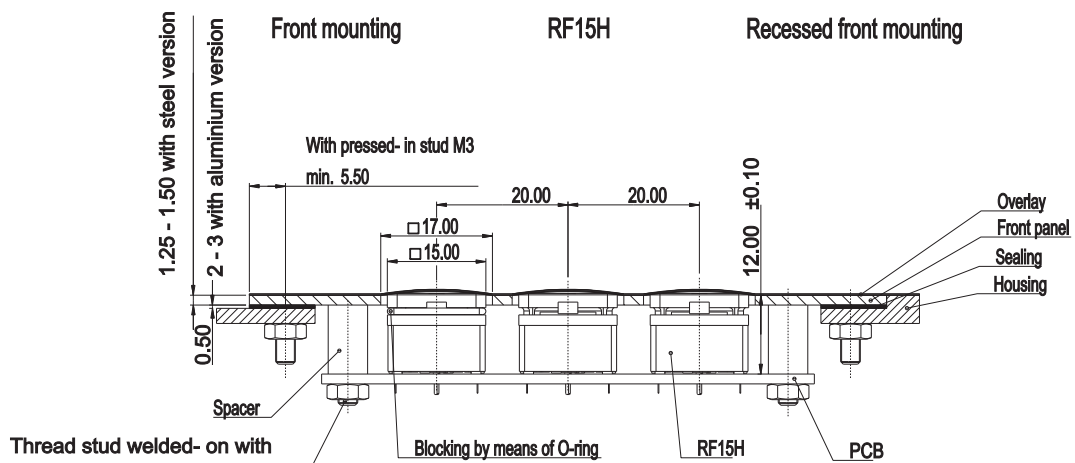

Hole Pattern

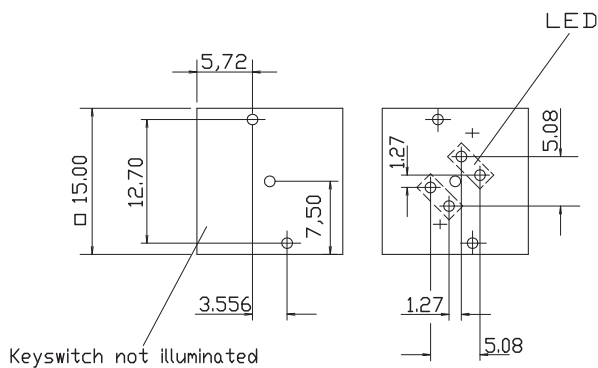

View on component side.

Hole Pattern – Front Panel

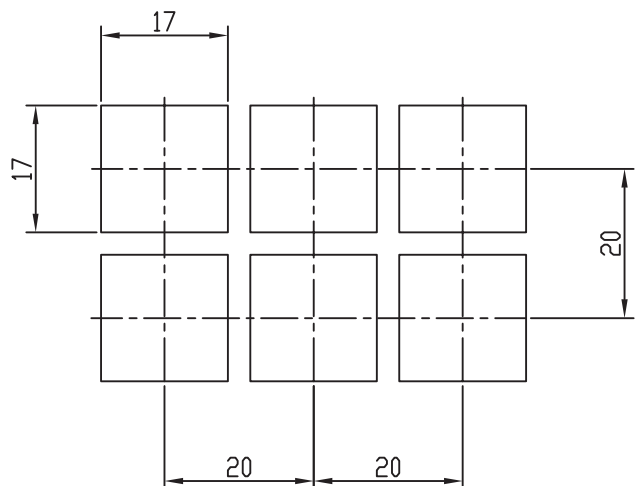

PCB KEY SWITCHES

RF 15 H - TACTILE SWITCHES



RF 15 H Tactile switch, non-illuminated

Technical data see page 4 - 73

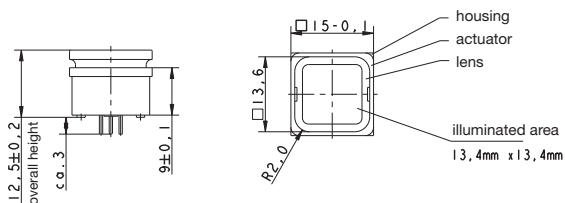

→ Contact materials	Illumination	Color of lens	LED color	LED type	Order no.
Au	not illuminated	white	-	-	3.14.100.702/0000
Ag	not illuminated	white	-	-	3.14.100.707/0000



RF 15 H Tactile switch, fully illuminated

Technical data see page 4 - 73

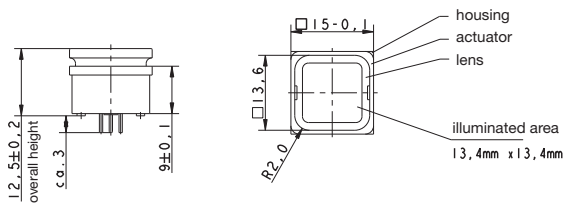

→ Contact materials	Illumination	Color of lens	LED color	LED type	Order no.
Au	fully illuminated 2 LED	red	red	2 mm	3.14.200.731/0000
Au	fully illuminated 2 LED	yellow	yellow	2 mm	3.14.200.733/0000
Au	fully illuminated 2 LED	orange	yellow	2 mm	3.14.200.738/0000
Au	fully illuminated 1 LED	green	green super bright	3 mm	3.14.200.736/0000
Au	fully illuminated 2 LED	green	green	2 mm	3.14.200.732/0000
Au	fully illuminated 1 LED	blue	blue	3 mm	3.14.200.739/0000
Au	fully illuminated 1 LED	white	white	3 mm	3.14.200.735/0000
Ag	fully illuminated 2 LED	red	red	2 mm	3.14.200.741/0000
Ag	fully illuminated 2 LED	yellow	yellow	2 mm	3.14.200.743/0000
Ag	fully illuminated 2 LED	orange	yellow	2 mm	3.14.200.748/0000
Ag	fully illuminated 1 LED	green	green super bright	3 mm	3.14.200.746/0000

– Table (continued) –
RF 15 H - Tactile switch, fully illuminated

→ Contact materials	Illumination	Color of lens	LED color	LED type	Order no.
Ag	fully illuminated 2 LED	green	green	2 mm	3.14.200.742/0000
Ag	fully illuminated 1 LED	blue	blue	3 mm	3.14.200.749/0000
Ag	fully illuminated 1 LED	white	white	3 mm	3.14.200.745/0000

When using the key switches with multicolor LEDs the illumination color can be varied from red to green by change of polarity. Due to the frequency of the polarity-changes the colors red, green, yellow as well as all secondary colors from these are possible.

Technical data of LED see separate page at the beginning of this chapter.

PCB KEY SWITCHES

RF 15 - SIGNAL INDICATORS



RF 15 Signal indicators

Technical Data

→ **General information**

Color of lens	see order block
Recommended key grid	19.05 mm

→ **Dimensions**

Length	15 mm
Width	15 mm
Overall height	9.15 mm

→ **Mechanical design**

Mounting	THT soldering in PCB
Illumination	fully illuminated 1 LED
LED color	see order block
LED type	2 mm

→ **Other specifications**

Ambient temp. operating min.	-25 °C
Ambient temp. operating max.	+70 °C
Environmental resistance	acc. to IEC 60068-2-14, -30, -33 and -78
Solderability / solder heat resistance	according to DIN EN 60068-2-20
Wave soldering	260 °C max.
Manual soldering	350 °C / 5 sec. max.
ROHS compliant	yes
REACH compliant	yes

PCB KEY SWITCHES

RF 15 - SIGNAL INDICATORS



RF 15 Signal indicator, fully illuminated, 1 LED

Technical data see page 4 - 78

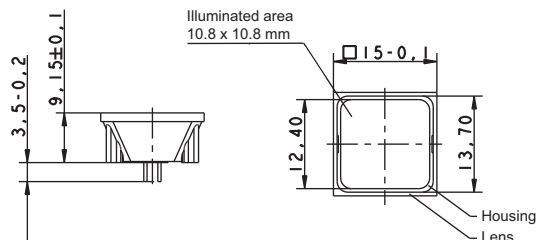

→ Overall height	Illumination	Color of lens	LED color	LED type	Order no.
9.15 mm	fully illuminated 1 LED	red	red	2 mm	3.14.200.051/0000
9.15 mm	fully illuminated 1 LED	yellow	yellow	2 mm	3.14.200.053/0000
9.15 mm	fully illuminated 1 LED	orange	yellow	2 mm	3.14.200.054/0000
9.15 mm	fully illuminated 1 LED	green	green	2 mm	3.14.200.052/0000
9.15 mm	fully illuminated 1 LED	blue	blue	2 mm	3.14.200.055/0000

Technical data of LED see separate page at the beginning of chapter 4 PCB Key switches.

RF 19 Tactile switches

→ Application notes:

RF 19 keys offer a large actuation area. When designing low-profile keyboards with a grid of ≥ 23 mm, frame webs remain free between the individual keys.

The overlay can be glued onto these frame webs; we recommend area embossing over the keys for the overlay.



Technical Data

→ General information

Color of lens	see order block
Recommended key grid	23 mm

→ Dimensions

Length	19.05 mm
Width	19.05 mm
Overall height	9.7 mm

→ Mechanical design

Mounting	soldering in PCB
Terminals	THT
Contact system	snap-action contact
Contact arrangement	1 NO
Contact materials	see order block
Illumination	see order block
LED color	see order block
LED type	see order block

→ Mechanical characteristics

Operating force max.	2.9 ^{+0.6} N
Switching travel	0.5 ^{+0.2} mm
Robustness max.	with through-plated PCB 100 N

→ Electrical characteristics

Rated voltage min.	Au: 0.02 V, Ag: 3 V
Rated voltage max.	35 V
Rated current min.	Au: 0.01 mA, Ag: 0.1 mA
Rated current max.	Au: 100 mA, Ag: 250 mA
Rated power max. (ohmic load)	Au: 2 W, Ag: 12.5 W
Contact resistance when new max.	100 m Ω
Insulation resistance	10 ⁹ Ω

→ Other specifications

Ambient temp. operating min.	-25 °C
Ambient temp. operating max.	+70 °C
Environmental resistance	acc. to IEC 60068-2-14, -30, -33 and -78
Operating life min. (operations)	1,000,000
Solderability / solder heat resistance	according to DIN EN 60068-2-20
Wave soldering	260 °C max.
Manual soldering	350 °C / 5 sec. max.
ROHS compliant	yes
REACH compliant	yes



PCB KEY SWITCHES

RF 19 - TACTILE SWITCHES

Typical force travel diagram RF 19

Actuating characteristics
Force travel diagram

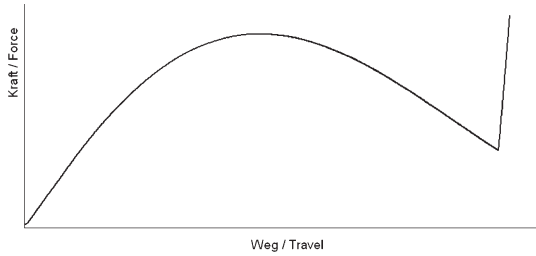

Circuit diagrams RF 19

Hole patterns (view on component side)

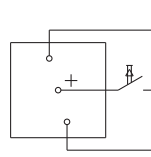

Tactile switch, non-illuminated

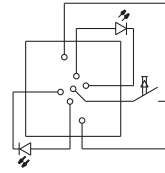

Tactile switch, fully-illuminated

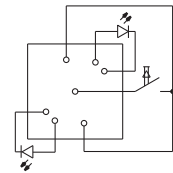

Tactile switch, spot-illuminated

System assembly RF 19

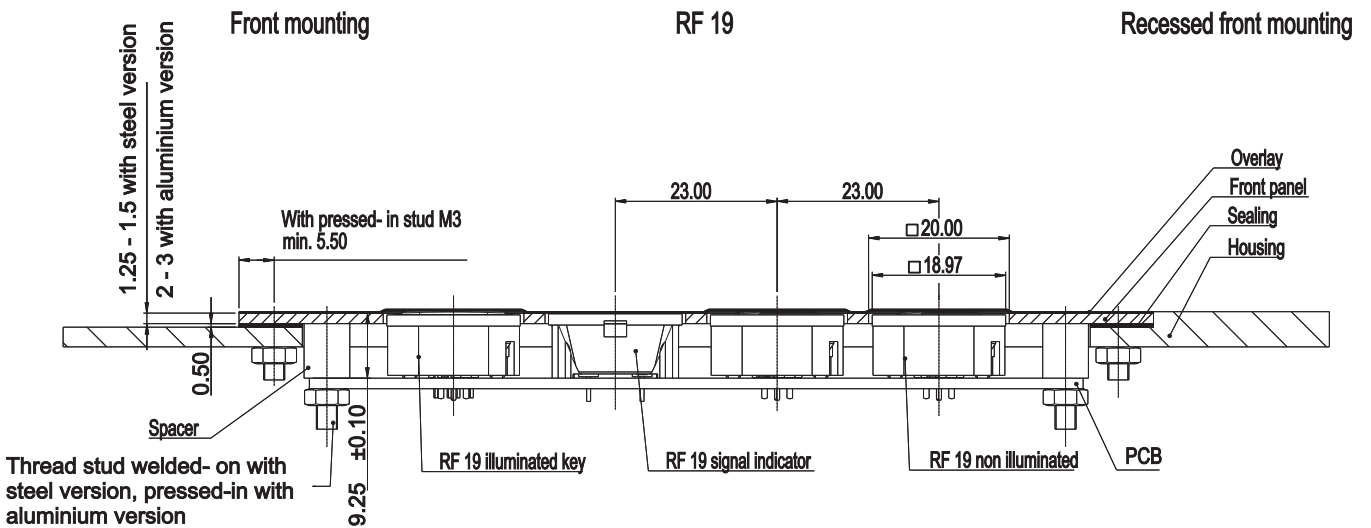

4

RF

PCB KEY SWITCHES

RF 19 - TACTILE SWITCHES



RF 19 Tactile switch, non-illuminated

Technical data see page 4 - 81

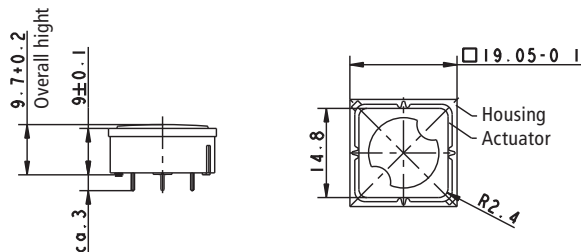

→ Contact materials	Illumination	Color of lens	LED color	LED type	Order no.
Au	not illuminated	transparent	-	-	3.14.001.001/0000
Ag	not illuminated	transparent	-	-	3.14.001.006/0000



RF 19 Tactile switch, fully illuminated with 2 LED

Technical data see page 4 - 81

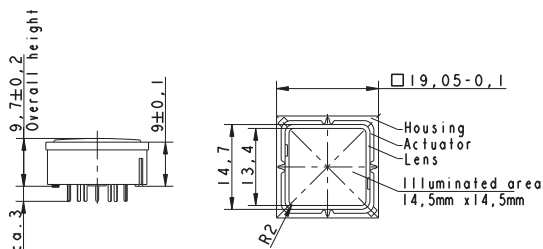

→ Contact materials	Illumination	Color of lens	LED color	LED type	Order no.
Au	fully illuminated 2 LED	red	red	2 mm	3.14.002.011/0000
Au	fully illuminated 2 LED	yellow	yellow	2 mm	3.14.002.013/0000
Au	fully illuminated 2 LED	orange	yellow	2 mm	3.14.002.014/0000
Au	fully illuminated 2 LED	green	green	2 mm	3.14.002.012/0000
Au	fully illuminated 2 LED	blue	blue	2 mm	3.14.002.015/0000
Au	fully illuminated 2 LED	opaque white	green	2 mm	3.14.002.901/0000
Ag	fully illuminated 2 LED	red	red	2 mm	3.14.002.021/0000
Ag	fully illuminated 2 LED	yellow	yellow	2 mm	3.14.002.023/0000
Ag	fully illuminated 2 LED	orange	yellow	2 mm	3.14.002.024/0000
Ag	fully illuminated 2 LED	green	green	2 mm	3.14.002.022/0000

– Table (continued) –
RF 19 - Tactile switch, fully illuminated with 2 LED

→ Contact materials	Illumination	Color of lens	LED color	LED type	Order no.
Ag	fully illuminated 2 LED	blue	blue	2 mm	3.14.002.025/0000
Ag	fully illuminated 2 LED	white	yellow	2 mm	3.14.002.027/0000
Ag	fully illuminated 2 LED	white	green	2 mm	3.14.002.026/0000
Ag	fully illuminated 2 LED	opaque white	green	2 mm	3.14.002.944/0000

Technical data of LED see separate page at the beginning of this chapter.

RF 19 Tactile switch, 1 LED spot-illumination

Technical data see page 4 - 81

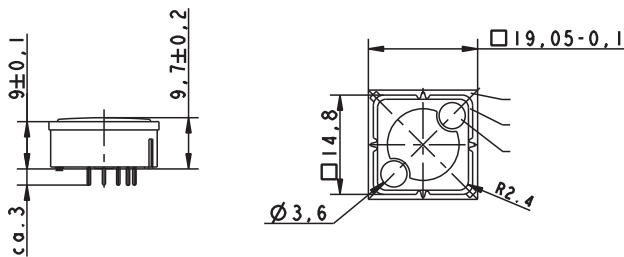

→ Contact materials	Illumination	Color of lens	LED color	LED type	Order no.
Au	spot illumination 1 LED	transparent	red	3 mm	3.14.001.031/0000
Au	spot illumination 1 LED	transparent	yellow	3 mm	3.14.001.033/0000
Au	spot illumination 1 LED	transparent	green	3 mm	3.14.001.032/0000
Au	spot illumination 1 LED	opaque white	blue	3 mm	3.14.001.030/0000
Ag	spot illumination 1 LED	transparent	red	3 mm	3.14.001.041/0000
Ag	spot illumination 1 LED	transparent	yellow	3 mm	3.14.001.043/0000
Ag	spot illumination 1 LED	transparent	green	3 mm	3.14.001.042/0000
Ag	spot illumination 1 LED	transparent	blue	3 mm	3.14.001.040/0000

Versions with 2 LEDs available on request.

Technical data of LED see separate page at the beginning of this chapter.

PCB KEY SWITCHES

RF 19 H - TACTILE SWITCHES

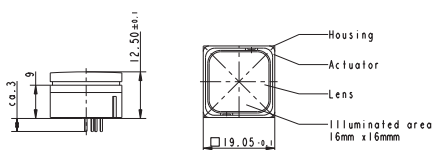

RF 19 H Tactile switches

→ Application notes:

The RF 19H key has an overall height of 12.5 mm and can be fully illuminated. When designing membrane keyboards, we recommend using a key grid of at least 24 mm and a 0.13 mm overlay with area embossing over the keys.

You can use the O-ring (accessory) to block the key and use it as an indicator field or blank spaceholder.

Technical Data

→ General information

Color of lens	see order block
Recommended key grid	24 mm

→ Dimensions

Length	19.05 mm
Width	19.05 mm
Overall height	12.5 mm

→ Mechanical design

Mounting	soldering in PCB
Terminals	THT
Contact system	snap-action contact
Contact arrangement	1 NO
Contact materials	see order block
Illumination	see order block
LED color	see order block
LED type	see order block

→ Mechanical characteristics

Operating force max.	2.9 ^{±0.6} N
Switching travel	0.5 ^{±0.2} mm
Robustness max.	with through-plated PCB 100 N

→ Electrical characteristics

Rated voltage min.	Au: 0.02 V, Ag: 3 V
Rated voltage max.	35 V
Rated current min.	Au: 0.01 mA, Ag: 0.1 mA
Rated current max.	Au: 100 mA, Ag: 250 mA
Rated power max. (ohmic load)	Au: 2 W, Ag: 12.5 W
Contact resistance when new max.	100 mΩ
Insulation resistance	10 ⁹ Ω

→ Other specifications

Ambient temp. operating min.	-25 °C
Ambient temp. operating max.	+70 °C
Environmental resistance	acc. to IEC 60068-2-14, -30, -33 and -78
Operating life min. (operations)	1,000,000
Solderability / solder heat resistance	according to DIN EN 60068-2-20
Wave soldering	260 °C max.
Manual soldering	350 °C / 5 sec. max.
ROHS compliant	yes
REACH compliant	yes

4

RF

PCB KEY SWITCHES

RF 19 H - TACTILE SWITCHES

Accessories RF 19 H - Tactile switch

→ Description	Photo	Order no.	Additional accessories see page
O-ring, black, 16.0 x 1, for blocking RF 19H keys		5.30.125.007/0100	5 - 31

PCB KEY SWITCHES

RF 19 H - TACTILE SWITCHES

Typical force travel diagram RF 19 H

Actuating characteristics
Force travel diagram

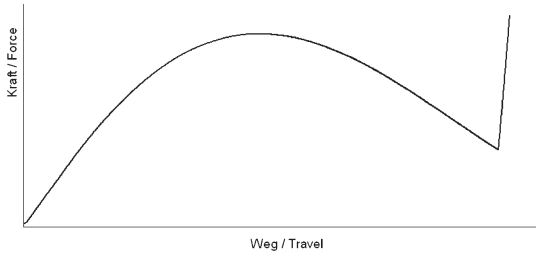

Circuit diagrams RF 19 H

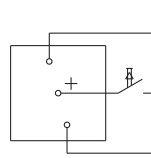

Tactile switch, non-illuminated

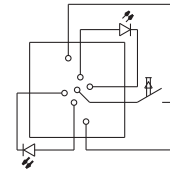

Tactile switch, fully-illuminated

System assembly RF 19 H

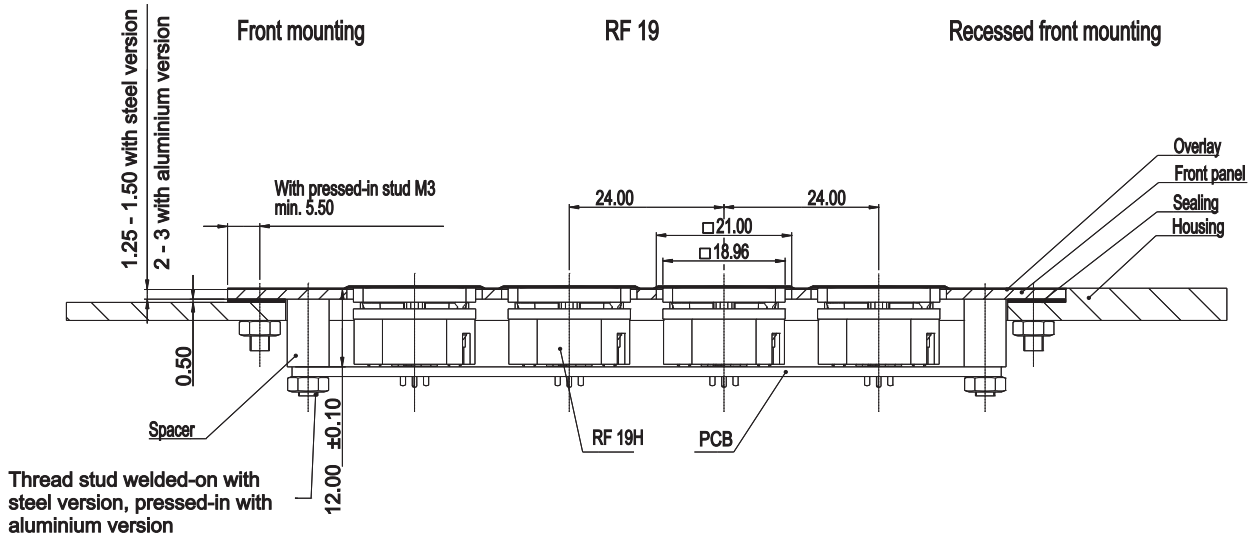

4

PCB hole patterns RF 19 H

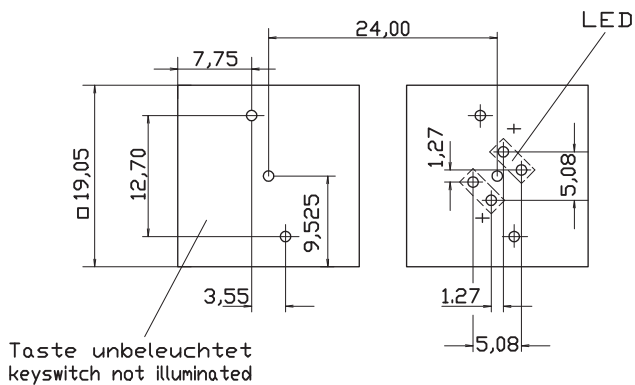

View on component side, all hole diameters $1.1^{+0.1}$ mm

Hole patterns front panel RF 19 H

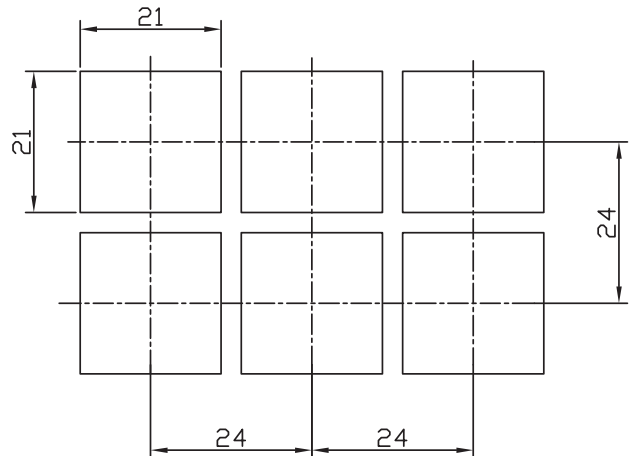

RF 19 H Tactile switch, non-illuminated

Technical data see page 4 - 86

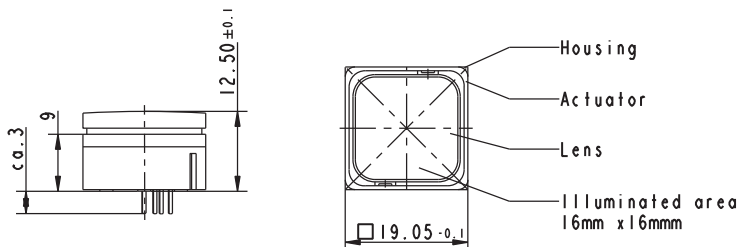

→ Contact materials	Illumination	Color of lens	LED color	LED type	Order no.
Au	not illuminated	white	-	-	3.14.001.501/0000
Ag	not illuminated	white	-	-	3.14.001.506/0000

RF 19 H Tactile switch, fully illuminated

Technical data see page 4 - 86

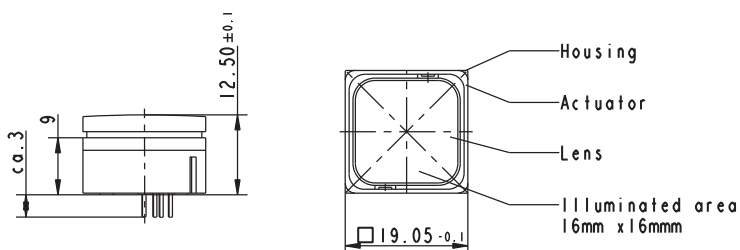

→ Contact materials	Illumination	Color of lens	LED color	LED type	Order no.
Au	fully illuminated 2 LED	red	red	2 mm	3.14.002.613/0000
Au	fully illuminated 2 LED	yellow	yellow	2 mm	3.14.002.653/0000
Au	fully illuminated 2 LED	orange	yellow	2 mm	3.14.002.673/0000
Au	fully illuminated 1 LED	green	green super bright	3 mm	3.14.002.633/0000
Au	fully illuminated 2 LED	green	green	2 mm	3.14.002.632/0000
Au	fully illuminated 1 LED	blue	blue	3 mm	3.14.002.683/0000
Au	fully illuminated 1 LED	white	white	3 mm	3.14.002.684/0000
Ag	fully illuminated 2 LED	red	red	2 mm	3.14.002.623/0000
Ag	fully illuminated 2 LED	yellow	yellow	2 mm	3.14.002.663/0000
Ag	fully illuminated 2 LED	orange	yellow	2 mm	3.14.002.678/0000
Ag	fully illuminated 1 LED	green	green super bright	3 mm	3.14.002.643/0000

PCB KEY SWITCHES

RF 19 H - TACTILE SWITCHES

– Table (continued) –
RF 19 H - Tactile switch, fully illuminated

→ Contact materials	Illumination	Color of lens	LED color	LED type	Order no.
Ag	fully illuminated 2 LED	green	green	2 mm	3.14.002.642/0000
Ag	fully illuminated 1 LED	blue	blue	3 mm	3.14.002.688/0000
Ag	fully illuminated 1 LED	white	white	3 mm	3.14.002.689/0000

When using the key switches with multicolor LEDs the illumination color can be varied from red to green by change of polarity. Due to the frequency of the polarity-changes the colors red, green, yellow as well as all secondary colors from these are possible.

Technical data of LED see separate page at the beginning of this chapter.

RF 19 Signal indicators

Technical Data

→ General information

Color of lens	see order block
Recommended key grid	23/x mm

→ Dimensions

Length	see order block
Width	see order block
Overall height	9.15 mm

→ Mechanical design

Mounting	THT soldering in PCB
Illumination	see order block
LED color	see order block
LED type	see order block

→ Other specifications

Ambient temp. operating min.	-25 °C
Ambient temp. operating max.	+70 °C
Environmental resistance	acc. to IEC 60068-2-14, -30, -33 and -78
Solderability / solder heat resistance	according to DIN EN 60068-2-20
Wave soldering	260 °C max.
Manual soldering	350 °C / 5 sec. max.
ROHS compliant	yes
REACH compliant	yes



RF 19 Signal indicator, 1/2 x 1-module

Technical data see page 4 - 91

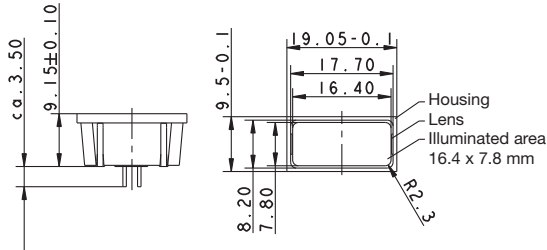

→ Illumination	Color of lens	LED color	LED type	Order no.
fully illuminated 1 LED	red	red	2 mm	3.14.002.061/0000
fully illuminated 1 LED	yellow	yellow	2 mm	3.14.002.063/0000
fully illuminated 1 LED	orange	yellow	2 mm	3.14.002.064/0000
fully illuminated 1 LED	green	green	2 mm	3.14.002.062/0000

Technical data of LED see separate page at the beginning of chapter 4 PCB Key switches.

RF 19 Signal indicator, 1/2 x 2-module

Technical data see page 4 - 91

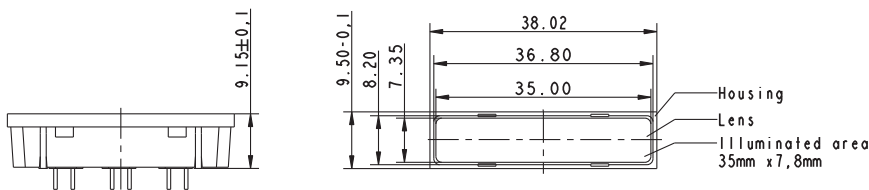
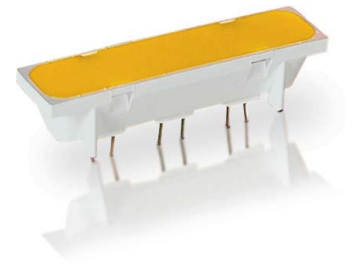

→ Illumination	Color of lens	LED color	LED type	Order no.
fully illuminated 3 LED	red	red	2 mm	3.14.002.908/0000
fully illuminated 3 LED	yellow	yellow	2 mm	3.14.002.910/0000
fully illuminated 3 LED	orange	yellow	2 mm	3.14.002.911/0000
fully illuminated 3 LED	green	green	2 mm	3.14.002.909/0000

Technical data of LED see separate page at the beginning of chapter 4 PCB Key switches.

PCB KEY SWITCHES

RF 19 - SIGNAL INDICATORS



RF 19 Signal indicator, 1 x 1-module

Technical data see page 4 - 91

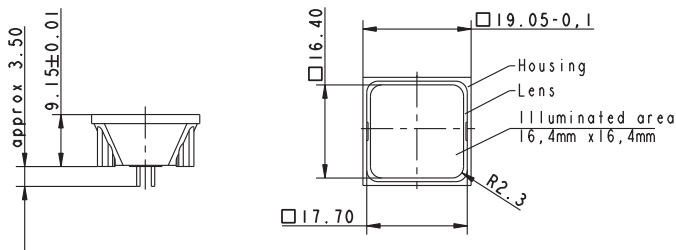

→ Illumination	Color of lens	LED color	LED type	Order no.
fully illuminated 2 LED	red	red	2 mm	3.14.002.051/0000
fully illuminated 2 LED	yellow	yellow	2 mm	3.14.002.053/0000
fully illuminated 2 LED	orange	yellow	2 mm	3.14.002.054/0000
fully illuminated 2 LED	green	green	2 mm	3.14.002.052/0000
fully illuminated 2 LED	blue	blue	2 mm	3.14.001.659/0000

For technical data of the LED see separate page at the beginning of chapter „RF tactile switches“

Suitable for RK 90 system design, illuminated for 2-module keycap.



RF 19 Signal indicator, 1 x 2-module

Technical data see page 4 - 91

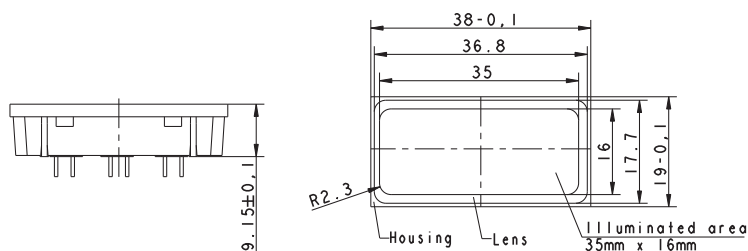

→ Illumination	Color of lens	LED color	LED type	Order no.
fully illuminated 5 LED	red	red	2 mm	3.14.002.071/0000
fully illuminated 5 LED	yellow	yellow	2 mm	3.14.002.073/0000
fully illuminated 5 LED	orange	yellow	2 mm	3.14.002.074/0000
fully illuminated 5 LED	green	green	2 mm	3.14.002.072/0000

For technical data of the LED see separate page at the beginning of chapter „RF tactile switches“

RF 15/19 Special accessories



RF 15 N Extension plunger, round head

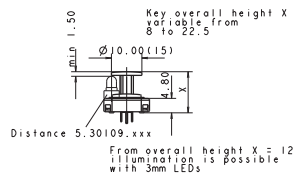
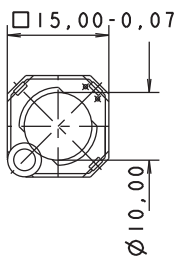

→ Length	Width	Overall height	Diameter	Color	Order no.
	-	9 mm	10 mm	-	5.46.011.036/0710
	-	9.7 mm	10 mm	-	5.46.011.030/0710
	-	12.5 mm	10 mm	-	5.46.011.037/0710
	-	13 mm	10 mm	-	5.46.011.038/0710
	-	22.5 mm	10 mm	-	5.46.011.028/0710

Length of plunger = Overall height - 4.25 mm.

PCB KEY SWITCHES

RF 15/19 - SPECIAL ACCESSORIES



RF 15 N Extension plunger, round head, with recess for LED

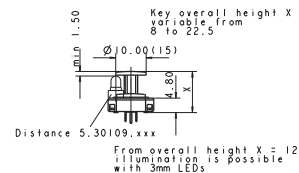
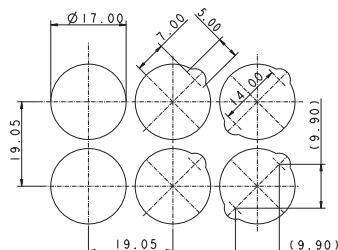

→ Length	Width	Overall height	Diameter	Color	Order no.
-	-	9 mm	15 mm	-	5.46.017.036/0710
-	-	9.7 mm	15 mm	-	5.46.017.030/0710
-	-	12.5 mm	15 mm	-	5.46.017.037/0710
-	-	22.5 mm	15 mm	-	5.46.017.028/0710
-	-	13 mm	15 mm	-	5.46.017.038/0710

Length of plunger = Overall height - 4.25 mm.



RF 15 Keycap, snap-on, for overall height 12.5 mm

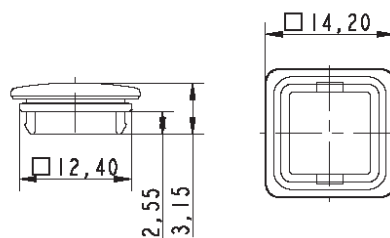

→ Length	Width	Overall height	Diameter	Color	Order no.
14.2 mm	14.2 mm	12.5 mm	-	beige	5.46.654.059/0227

4

RF

Spacer, round

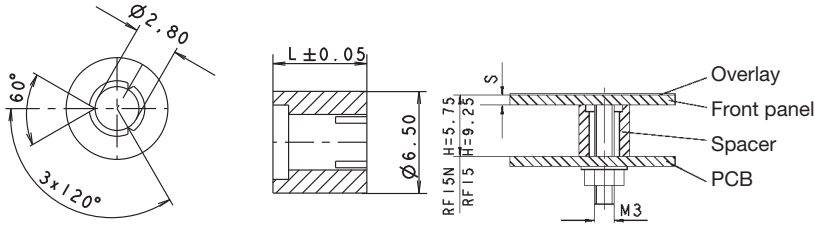

→ Length L	Color	Order no.
3.50 mm	blue transparent	5.30.759.023/0000
4.75 mm	blue transparent	5.30.759.028/0000
5.25 mm	yellow orange transparent	5.30.759.030/0000
4.50 mm	red	5.30.759.027/0000
5.50 mm	yellow	5.30.759.031/0000
4 mm	green	5.30.759.025/0000
5.75 mm	green	5.30.759.032/0000
4.25 mm	blue	5.30.759.026/0000
6 mm	blue	5.30.759.033/0000
6.2 mm	blue	5.30.759.251/0000
5 mm	black	5.30.759.029/0000
10.00 mm	black	5.30.759.043/0104
6.25 mm	red	5.30.759.034/0000
6.50 mm	blue transparent	5.30.759.035/0000
6.75 mm	black	5.30.759.036/0000
7 mm	yellow orange transparent	5.30.759.037/0000
7.25 mm	yellow	5.30.759.038/0000
7.50 mm	green	5.30.759.039/0000
7.75 mm	blue	5.30.759.040/0000
8 mm	red	5.30.759.041/0000
8.25 mm	blue transparent	5.30.759.042/0000

Required spacer length

For keyboards: Overall height of key - front panel thickness - 0.5 mm (area embossing).

For RAFIX 22 FS: 9.25 mm - front panel thickness - thickness of overlay, if existing

PCB KEY SWITCHES

RF 15/19 - SPECIAL ACCESSORIES



Spacer, triangular

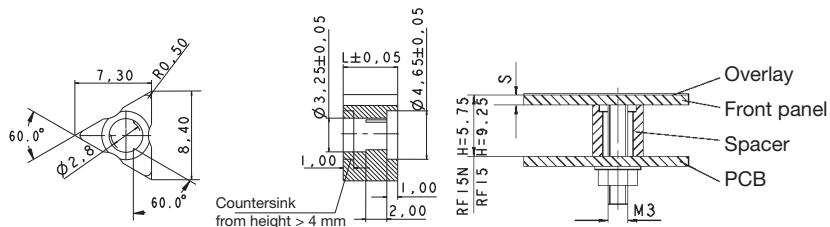

triangular version

→ Length L	Order no.
2.50 mm	5.30.759.094/0000
2.75 mm	5.30.759.095/0000
3 mm	5.30.759.096/0000
3.25 mm	5.30.759.097/0000
3.50 mm	5.30.759.098/0000
3.75 mm	5.30.759.099/0000
4 mm	5.30.759.100/0000
4.25 mm	5.30.759.101/0000
4.50 mm	5.30.759.102/0000
4.75 mm	5.30.759.103/0000
5 mm	5.30.759.104/0000
5.25 mm	5.30.759.105/0000
5.50 mm	5.30.759.106/0000
5.75 mm	5.30.759.107/0000
6 mm	5.30.759.108/0000
6.2 mm	5.30.759.253/0000
10.00 mm	5.30.759.124/0000
10.25 mm	5.30.759.125/0000
6.25 mm	5.30.759.109/0000
6.50 mm	5.30.759.110/0000
6.75 mm	5.30.759.111/0000
7 mm	5.30.759.112/0000
7.25 mm	5.30.759.113/0000
7.50 mm	5.30.759.114/0000
7.75 mm	5.30.759.115/0000
8 mm	5.30.759.116/0000
8.25 mm	5.30.759.117/0000
9 mm	5.30.759.254/0000

– Table (continued) –
Spacers, triangular

Required spacer length = Overall height of key - front panel thickness - 0.5 mm (area embossing).

RF 15 N LED spacer



→ Length	Width	Overall height	Diameter	Color	Order no.
2.2 mm	-	12.5 mm	5 mm	light grey	5.30.109.010/0756
12 mm	-	22.5 mm	5 mm	black	5.30.109.019/0105

PCB KEY SWITCHES

KN 19 - SHORT-TRAVEL MAIN SWITCH



KN 19

Short-travel main switch

Short-travel main switch for use in membrane keyboards under the overlay or with RK 90 keycaps, 250V, 4A max. A cut-out in the overlay is not required!

- All products are RoHS compliant.

4

KN 19

PCB KEY SWITCHES

KN 19 - SHORT-TRAVEL MAIN SWITCH

Content

KN 19 - Short-travel main switches

4 - 103

KN 19 - Short-travel main switch

4 - 104

4

KN 19

KN 19 Short-travel main switches

→ The KN 19 makes it possible to implement a power switch directly in a low-profile data entry system. This eliminates the need for extra switches on the device and additional openings in the overlay. In this way, you can achieve an optimum of safety and a consistent design.

The contact opening widths comply with the VDE standards. The KN 19 can also be employed underneath RK 90 keycaps. Other actuation functions (momentary, latching/momentary) available on request.



Technical Data

→ General information

Recommended key grid 19.05 x 38.1 mm

→ Dimensions

Length 37.8 mm
Width 18.8 mm
Overall height 9.7 mm

→ Mechanical design

Mounting on PCB
Terminals THT solder terminals
Contact system snap-action bridge contact
Contact arrangement see order block
Contact materials Ag
Illumination 1 LED (max. 3 mm) possible
Degree of protection IP40 (DIN EN 60529)
Hot wire ignition acc. to IEC 60695-2-1 850 °C

→ Mechanical characteristics

Operating force max. $9^{\pm 3}$ N
Operating travel $0.55^{\pm 0.15}$ mm
Robustness max. 100 N

→ Electrical characteristics

Rated voltage AC min. 12 V
Rated voltage DC min. 12 V
Rated voltage AC max. 250 V
Rated voltage DC max. 50 V
Ohmic load AC 6 A
Ohmic load DC max. 10 A
Ohmic load DC min. 0.1 A
Contact resistance when new max. 50 mΩ
Capacity input current AC max. 100 A
Rated motor current AC 4 A
Rated filament lamp current AC 2.4 A
Bouncing time max. 10 ms

→ Other specifications

Ambient temp. operating min. -25 °C
Ambient temp. operating max. +70 °C
Environmental resistance acc. to IEC 60068-2-14, -30, -33 and -78
Operating life AC AC 250 V: 200.000 /2A; 100.000 /6A
Operating life DC 50,000(10 A / 50 V=)
Soldering time max. 3 s
Soldering temperature max. 350 °C
Flame class acc. to UL 94 UL 94 VO
ROHS compliant yes
REACH compliant yes

Approvals



IEC 61058



UL 508, C22.2 No. 14-M91



PCB KEY SWITCHES

KN 19 - SHORT-TRAVEL MAIN SWITCH

Accessories KN 19 - Short-travel main switch

→ Description	Photo	Order no.	Additional accessories see page
KN19 - Absorption rubber		5.30.729.009/0000	-

Circuit diagrams



1 NC + 1 NO



2 NC/2 NO

Dimensional drawing

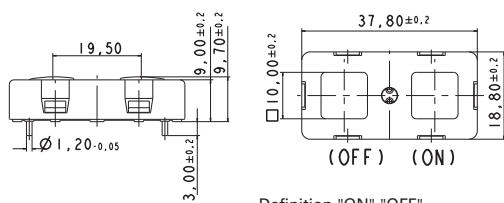

Definition "ON" "OFF"
only valid for 2-pole version.

PCB hole pattern

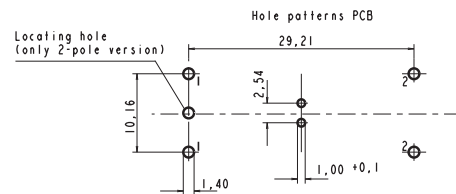

Locating hole only version 2 NO/2 NC

View on component side

4



KN 19 Short-travel main switch

Technical data see page 4 - 103

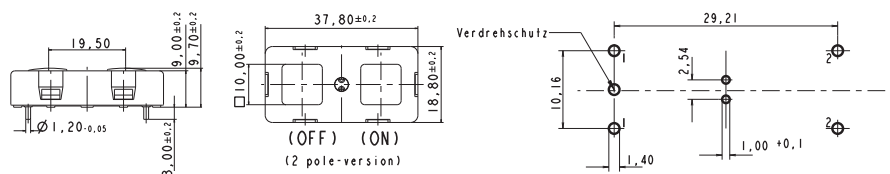

PCB footprint

→ Contact arrangement	Rated voltage AC max.	Order no.
1 NC + 1 NO	250 V	1.12.000.001/0000
2 NC / 2 NO	250 V	1.12.000.501/0000

For keycaps, refer to RK 90 system design.

Positive opening NC contacts to IEC 60 947-5-1.

1-LED spot-illumination (max. 3 mm) possible.

Accessoires:

KN19 - Absorption rubber: 5.30.729.009/0000

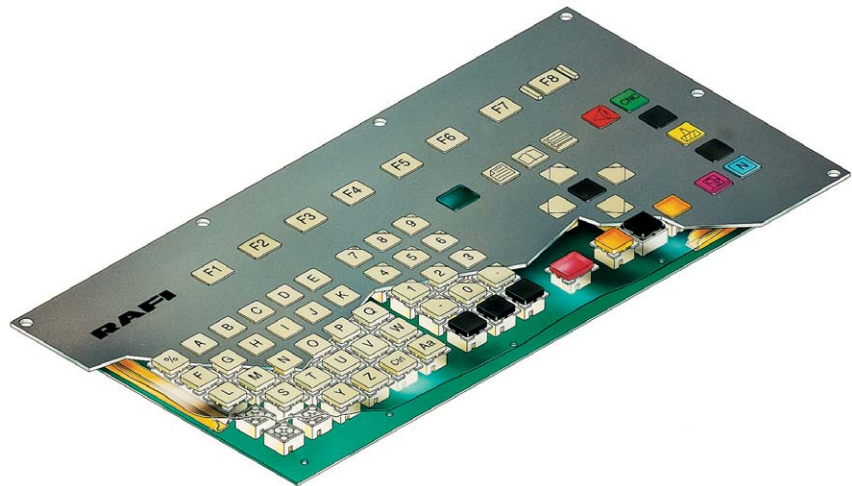

RK 90

Keycaps

Keycaps for RACON, RF 15 / RF 19 and KN 19 tactile switches

- You can insert a legend insert between lens and pressure pad of the transparent keycaps.
 - All products are RoHS compliant.
-

PCB KEY SWITCHES

RK 90 - KEYCAPS

Content

RK 90 - Keycaps, plastic, 9 x 9 mm	4 - 109
RK 90 - Keycap body plastic, for lenses 9 x 9 mm	4 - 110
RK 90 - Keycaps, plastic, 14 mm	4 - 111
RK 90 - Keycap body plastic, for lenses 14 mm, 1-module	4 - 112
RK 90 - Keycap body plastic, for lenses 1¼-module	4 - 112
RK 90 - Keycap body plastic, for lenses 14 mm, 1½-module	4 - 113
RK 90 - Keycap body plastic, for lenses 2-module	4 - 114
RK 90 - Keycaps, aluminum, 14 mm	4 - 115
RK 90 - Keycaps, aluminum, 14 mm, 1-module	4 - 116
RK 90 - Keycaps, aluminum, 14 mm, 1½-module	4 - 116
RK 90 - Keycaps, aluminum, 14 mm, 2-module	4 - 117
RK 90 - Special accessories	4 - 118
RK 90 - Fin, to avoid inadvertent operation	4 - 118
RK 90 - Spacer M 4	4 - 119
RK 90 - Silicone foil	4 - 119

Keycap system RK 90

Example with RF 15 key switches. Instead of RF 15 following key switches can be used:

- MICON 5
- RACON 8/12
- RF 15 tactile switches and signal indicators
- RF 19 tactile switches and signal indicators
- Short-travel main switch KN 19

The RK 90 system was granted the prize of the Design Forum of the Hannover Fair.

Degree of protection: IP65 according to DIN in front of the panel, with silicone sealing.

Installation methods

Installation from front

Installation from rear

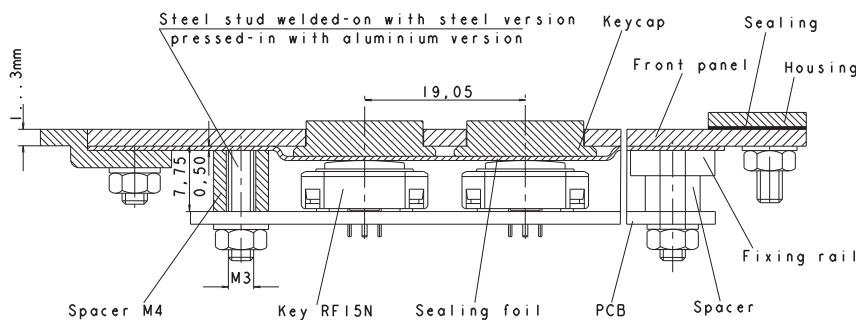

Mounting from front

Sealing foil between RK 90 keyboard and customer's front panel.

Mounting from rear

Sealing foil is screwed to RK 90 panel with fixing rails; sealing between keyboard and customer's front panel has to be provided.

Legending

- **Laser printing:** This labelling method is possible for opaque keycaps. The symbols are engraved in the keycaps with laser.
- When using transparent lenses, the pressure pad can be legended by printing.

As the legending is protected by the lens, it is friction-proof.

- **Engraving:** With this method the keycaps are engraved with the required symbol and then inlaid with ink.

PCB KEY SWITCHES

RK 90 - KEYCAP SYSTEM

Recommendations

- **Front panel thickness:**

- **Aluminum:** 2 mm (1.5 mm min, 3 mm max.)
(Fixing with M 3 pressed-in studs)

- **Steel:** 2 mm (3 mm max.); V2A: 1.25 mm
(Fixing with M 3 welded-on studs)

The keytop surface is flush with the keyboard at a panel thickness of 3.5 mm.

- **Silicone sealing:**

Material: Silicone transparent

Type: A-SY 40-79

Hardness: 30° shore +/- 5°

Thickness: 0.45 +/- 0.05 mm

- **Installation:** Ensure that the keyboard slopes slightly so that any liquid can drain away between front panel and silicone sealing; if necessary, provide additional drain holes in the front panel.

Cleaning liquids

For the cleaning of the plastic keycaps please do not use cleaning liquids based on alcohol or acid.

RK 90 Keycaps, plastic, 9 x 9 mm



Installation from front

Installation for rear

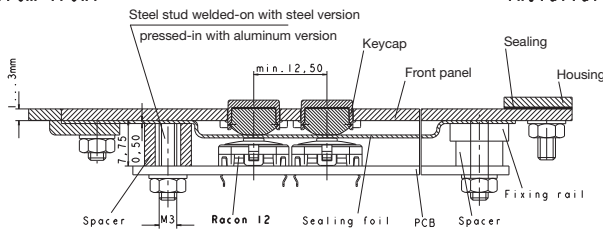

→ You can design especially small input fields with the small keycap 9 x 9 mm. For example, controls for measurement and laboratory equipment which do not offer much space for input fields because of their small size. RK 90 keycaps 9 x 9 mm and RACON tactile switches can be used to implement key grids of only 12.5 mm. The keycaps can be legended by laser-printing, engraving or standard printing. This keycap is our first choice in a combination with the illuminated RACON 12 i tactile switch.

Please note: For the cleaning of the plastic keycaps please do not use cleaning liquids based on alcohol or acid.

Technical Data

→ General information

Color of lens	see order block
Size	1-module
Degree of protection (with silicon seal)	IP65 (DIN EN 60529)
Illuminability	see order block

→ Dimensions

Dimension keycap in front of front panel	8.85 x 8.85 mm
Dimension keycap behind front panel	11.5 x 11.5 mm
Dimension (c) hole patterns final size	9.00 x 9.00 mm
Dimension hole patterns punched size	9.20 x 9.20 mm

→ Other specifications

ROHS compliant	yes
REACH compliant	yes

Please order lens separately.

PCB KEY SWITCHES

RK 90 - KEYCAPS, PLASTIC, 9 X 9 MM

RK 90 Keycap body plastic, for lenses 9 x 9 mm



Technical data see page 4 - 109

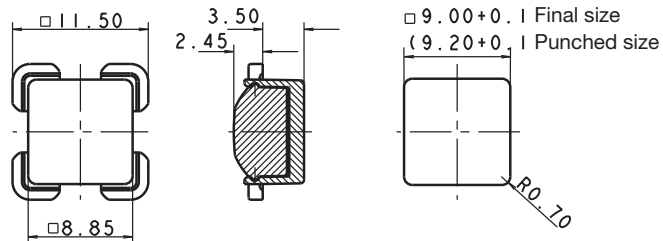

→ Size	Illuminability	Dimension keycap behind front panel	Dimension keycap in front of front panel	Dimension (c) hole patterns final size	Order no.
1-module	yes	11.5 x 11.5 mm	8.85 x 8.85 mm	9.00 x 9.00 mm	5.55.103.265/1013

Laser printed opaque lenses and keycap sets on request.

Please order lenses separately.

Lenses:

- RK 90 - Lens, 9 x 9 mm, opaque red: 5.46.651.015/0309
- RK 90 - Lens, 9 x 9 mm, opaque yellow: 5.46.651.015/0409
- RK 90 - Lens, 9 x 9 mm, opaque green: 5.46.651.015/0514
- RK 90 - Lens, 9 x 9 mm, opaque blue: 5.46.651.015/0611
- RK 90 - Lens, 9 x 9 mm, opaque light grey: 5.46.651.015/0700
- RK 90 - Lens, 9 x 9 mm, transparent colorless: 5.46.651.019/1002
- RK 90 - Lens, 9 x 9 mm, transparent red: 5.46.651.019/1307
- RK 90 - Lens, 9 x 9 mm, transparent yellow: 5.46.651.019/1403
- RK 90 - Lens, 9 x 9 mm, transparent green: 5.46.651.019/1510

RK 90 Keycaps, plastic, 14 mm

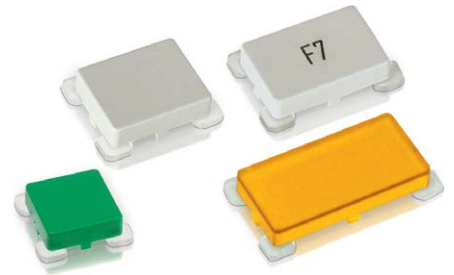

Installation from front

Installation from rear

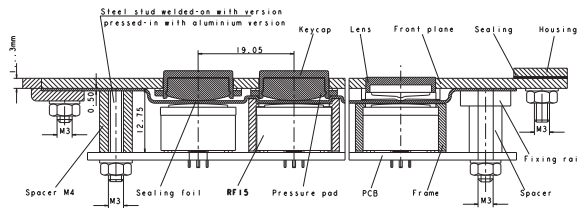

→ Keycap system for 19.05 mm grid. The keycaps can be legended by laser-printing, engraving or standard printing. Keycaps / sets with legends and other keycap shapes / colors available on request.

Please note: For the cleaning of the plastic keycaps please do not use cleaning liquids based on alcohol or acid.

Technical Data

→ General information

Color of lens	see order block
Size	see order block
Degree of protection (with silicon seal)	IP65 (DIN EN 60529)
Illuminability	yes

→ Dimensions

Dimension (b) in front of front panel	see order block
Dimension (a) behind front panel	see order block
Dimension (c) hole patterns final size	see order block
Dimension hole patterns punched size	see order block

→ Other specifications

ROHS compliant	yes
REACH compliant	yes

PCB KEY SWITCHES

RK 90 - KEYCAPS, PLASTIC 14 MM



RK 90 Keycap body plastic, for lenses 14 mm, 1-module

Technical data see page 4 - 111

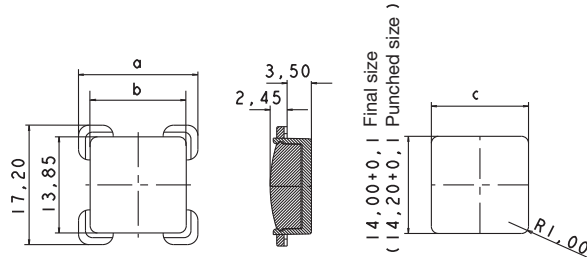

→ Size	Illuminability	Dimension (a) behind front panel	Dimension (b) in front of front panel	Dimension (c) hole patterns final size	Order no.
1-module	yes	17.20 x 17.20 mm	13.85 x 13.85 mm	14.00 x 14.00 mm	5.55.103.030/1013

Lenses:

- RK 90 - Lens, 14 x 14 mm, 1-module, opaque red: 5.46.681.001/0309
- RK 90 - Lens, 14 x 14 mm, 1-module, opaque yellow: 5.46.681.001/0409
- RK 90 - Lens, 14 x 14 mm, 1-module, opaque green: 5.46.681.001/0514
- RK 90 - Lens, 14 x 14 mm, 1-module, opaque blue: 5.46.681.001/0611
- RK 90 - Lens, 14 x 14 mm, 1-module, opaque light grey: 5.46.681.001/0700
- RK 90 - Lens, 14 x 14 mm, 1-module, transparent colorless: 5.46.681.021/1002
- RK 90 - Lens, 14 x 14 mm, 1-module, transparent red: 5.46.681.021/1307
- RK 90 - Lens, 14 x 14 mm, 1-module, transparent yellow: 5.46.681.021/1403
- RK 90 - Lens, 14 x 14 mm, 1-module, transparent green: 5.46.681.021/1510

4



RK 90 Keycap body plastic, for lenses 1 ¼-module

Technical data see page 4 - 111

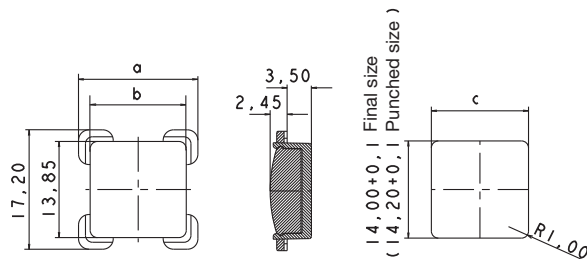

→ Size	Illuminability	Dimension (a) behind front panel	Dimension (b) in front of front panel	Dimension (c) hole patterns final size	Order no.
1 ¼-module	yes	17.20 x 20.7 mm	13.85 x 17.35 mm	14,00 x 17,5 mm	5.55.103.031/1013

Lenses:

- RK 90 - Lens, 14 mm, 1.25-module, opaque red: 5.46.681.002/0309

– Table (continued) –

RK 90 - Keycap body plastic, for lenses 1¼-module

- RK 90 - Lens, 14 mm, 1.25-module, opaque light grey: 5.46.681.002/0700
- RK 90 - Lens, 14 mm, 1.25-module, transparent colorless: 5.46.681.022/1002
- RK 90 - Lens, 14 mm, 1.25-module, transparent red: 5.46.681.022/1307
- RK 90 - Lens, 14 mm, 1.25-module, transparent yellow: 5.46.681.022/1403
- RK 90 - Lens, 14 mm, 1.25-module, transparent green: 5.46.681.022/1510

RK 90 Keycap body plastic, for lenses 14 mm, 1½-module

Technical data see page 4 - 111

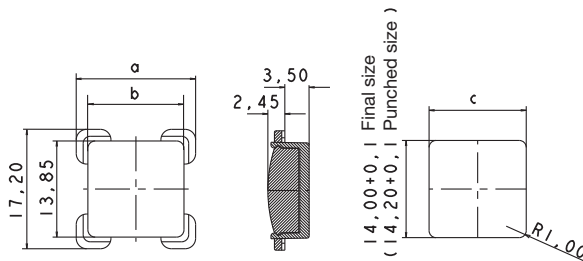

→ Size	Illuminability	Dimension (a) behind front panel	Dimension (b) in front of front panel	Dimension (c) hole patterns final size	Order no.
1½-module	yes	17.20 x 24.20 mm	13.85 x 20.85 mm	14.00 x 21.00 mm	5.55.103.032/1013

Lenses:

- RK 90 - Lens, 14 mm, 1.5-module, opaque red: 5.46.681.003/0309
- RK 90 - Lens, 14 mm, 1.5-module, opaque yellow: 5.46.681.003/0409
- RK 90 - Lens, 14 mm, 1.5-module, opaque green: 5.46.681.003/0514
- RK 90 - Lens, 14 mm, 1.5-module, opaque blue: 5.46.681.003/0611
- RK 90 - Lens, 14 mm, 1.5-module, opaque light grey: 5.46.681.003/0700
- RK 90 - Lens, 14 mm, 1.5-module, transparent colorless: 5.46.681.023/1002
- RK 90 - Lens, 14 mm, 1.5-module, transparent red: 5.46.681.023/1307
- RK 90 - Lens, 14 mm, 1.5-module, transparent yellow: 5.46.681.023/1403
- RK 90 - Lens, 14 mm, 1.5-module, transparent green: 5.46.681.023/1510

PCB KEY SWITCHES

RK 90 - KEYCAPS, PLASTIC 14 MM

RK 90 Keycap body plastic, for lenses 2-module



Technical data see page 4 - 111

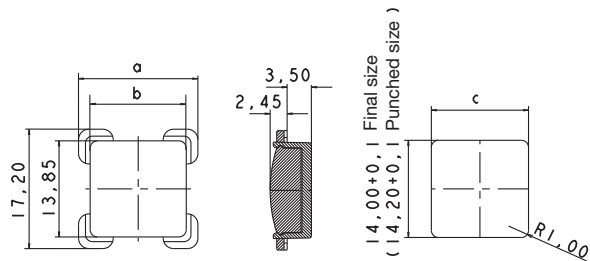

→ Size	Illuminability	Dimension (a) behind front panel	Dimension (b) in front of front panel	Dimension (c) hole patterns final size	Order no.
2-module	yes	17.20 x 31.20 mm	13.85 x 27.85 mm	14.00 x 28.00 mm	5.55.103.077/1013

Lenses:

- RK 90 - Lens, 14 mm, 2-module, opaque red: 5.46.681.004/0309
- RK 90 - Lens, 14 mm, 2-module, opaque yellow: 5.46.681.004/0409
- RK 90 - Lens, 14 mm, 2-module, opaque green: 5.46.681.004/0514
- RK 90 - Lens, 14 mm, 2-module, opaque blue: 5.46.681.004/0611
- RK 90 - Lens, 14 mm, 2-module, opaque light grey: 5.46.681.004/0700
- RK 90 - Lens, 14 mm, 2-module, transparent colorless: 5.46.681.024/1002
- RK 90 - Lens, 14 mm, 2-module, transparent red: 5.46.681.024/1307
- RK 90 - Lens, 14 mm, 2-module, transparent yellow: 5.46.681.024/1403
- RK 90 - Lens, 14 mm, 2-module, transparent green: 5.46.681.024/1510

RK 90 Keycaps, aluminum, 14 mm

- The RK 90 system design with metal keycaps is fairly safe against mechanical, thermal or chemical effects. Combined with a metal front panel, this data entry system offers maximum protection against vandalism. Tried and tested MICON 5, RACON 8/12 or RF 15/19 PCB key switches are used underneath the metal keycaps.
- The keycaps can be provided with engraved, colored anodized or laser-printed legends. This means that the legend is durable and cannot be removed by mechanical or chemical means.



Technical Data

→ General information

Color of lens	aluminum colorless anodized
Size	see order block
Degree of protection (with silicon seal)	IP65 (DIN EN 60529)

→ Dimensions

Dimension (b) in front of front panel	see order block
Dimension (a) behind front panel	see order block
Dimension (c) hole patterns final size	see order block
Dimension hole patterns punched size	see order block

→ Other specifications

ROHS compliant	yes
REACH compliant	yes

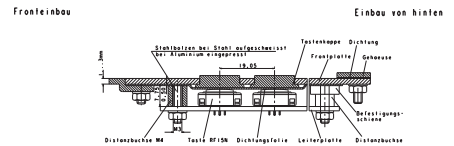
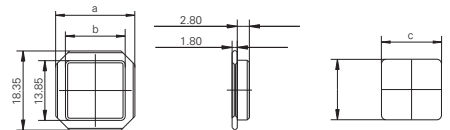

PCB KEY SWITCHES

RK 90 - KEYCAPS, ALUMINIUM, 14 MM



RK 90 Keycaps, aluminum, 14 mm, 1-module

Technical data see page 4 - 115

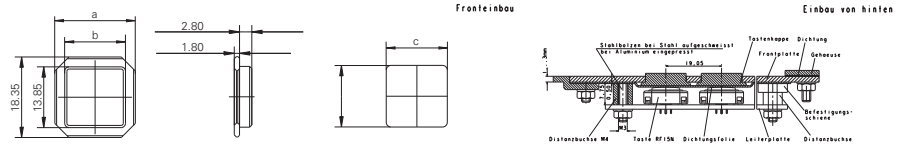

→ Size	Color of lens	Dimension (a) behind front panel	Dimension (b) in front of front panel	Dimension (c) hole patterns final size	Order no.
1-module	aluminum colorless anodized	18.35 x 18.35 mm	13.85 x 13.85 mm	14.00 x 14.00 mm	5.46.500.001/4010



RK 90 Keycaps, aluminum, 14 mm, 1 1/2-module

Technical data see page 4 - 115

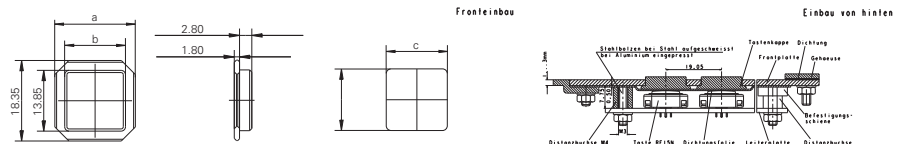

→ Size	Color of lens	Dimension (a) behind front panel	Dimension (b) in front of front panel	Dimension (c) hole patterns final size	Order no.
1 1/2-module	aluminum colorless anodized	18.35 x 25.35 mm	13.85 x 20.85 mm	14.00 x 21.00 mm	5.46.500.003/4010

4

RK 90

PCB KEY SWITCHES

RK 90 - SPECIAL ACCESSORIES



RK 90 Special accessories

RK 90 Fin, to avoid inadvertent operation

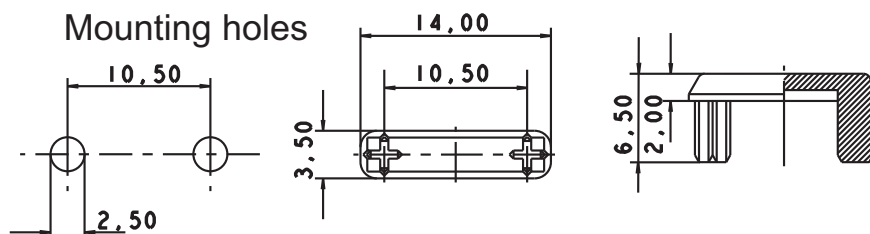

4

→ Description	Color	Order no.
RK 90 - Fin, to avoid inadvertent operation, light grey	opaque light grey	5.55.103.079/0700
RK 90 - Fin, to avoid inadvertent operation, charcoal grey	opaque light grey	5.55.103.079/0152

RK 90

RK 90 Spacer M 4



→ Length L	Color	Order no.
12.5 mm overall height for RF 15 mm	-	5.30.764.040/0000
9.25 mm overall height, for RF 15 mm	-	5.30.764.027/0000
5.5 mm overall height, for RF15 N mm	-	5.30.764.010/0000
7.5 mm overall height for RACON 8/12 mm	-	5.30.764.018/0000
4.25 mm overall height, for RACON 8/12 mm	-	5.30.764.005/0000

Mounting from front (1 pc. per stud)

RK 90 Silicone foil



→ Color	Dimensions	Order no.
transparent	600 x 590 x 0.45 mm	7.16.102.006/0000

PCB KEY SWITCHES

RG 85 III - PUSHBUTTONS/KEYS



RG 85 III

Short-travel system

Vandal-proof input system, ideally suited for elevator controls, info terminals, vending machines, etc.

- Edge illumination and symbol illumination possible
- Connection: Each module individually with an 8-pin Micro-Match socket connector
- Modular fixing system with quick fasteners or single fixing
- Contact arrangement: 1 NO contact
- 35 V/250 mA max.
- Degree of protection IP65 (keylock switch IP40).
- Elevator standardm EN 81-70
- All products are RoHS compliant.

4

RG
85 III

PCB KEY SWITCHES

RG 85 III - PUSHBUTTONS/KEYS

Content

RG 85 III - Key switches	4 - 125
RG 85 III - Key switch, round design, without lens	4 - 126
RG 85 III - Key switch, square design, without lens	4 - 126
RG 85 III - Keylock switches	4 - 128
RG 85 III - Keylock switch, round design, without lens	4 - 129
RG 85 III - Keylock switch, square design, without lens	4 - 129
RG 85 III - Signal indicators, without lens	4 - 131
RG 85 III - Signal indicator, without lens	4 - 132
RG 85 III - Accessories	4 - 133
RG 85 III - Lens for key switches, round	4 - 133
RG 85 III - Lens for key switches, square	4 - 134
RG 85 III - Lens for key switches, round flush, elevator standard EN 81-70	4 - 135
RG 85 III - Lens for key switches, round protruding, elevator standard EN 81-70	4 - 136
RG 85 III - Lens for key switches, square flush, elevator standard EN 81-70	4 - 137
RG 85 III - Lens for key switches, square protruding, elevator standard EN 81-70	4 - 138
RG 85 III - Lens for keylock switches, round	4 - 139
RG 85 III - Lens for keylock switches, square	4 - 139
RG 85 III - Lens, round, for signal indicators	4 - 140
RG 85 III - Lens, square, for signal indicators	4 - 140
RG 85 III - Lens, triangular, for signal indicators	4 - 141
Cable, 8 wire, with socket connectors on both ends	4 - 141
Fixing rail, length 490 mm	4 - 142
Spacer	4 - 142
Fixing piece for mounting the elements with the rail fixing method	4 - 142

System Features

Perfectly suited for: elevator controls, info terminals, vending machines, etc.

- Vandal proof construction
- Modular fixing system with quick fasteners or single fixing method using thread studs
- Connection with keyed 8-pin micro-match connector
- Degree of protection: IP40/65

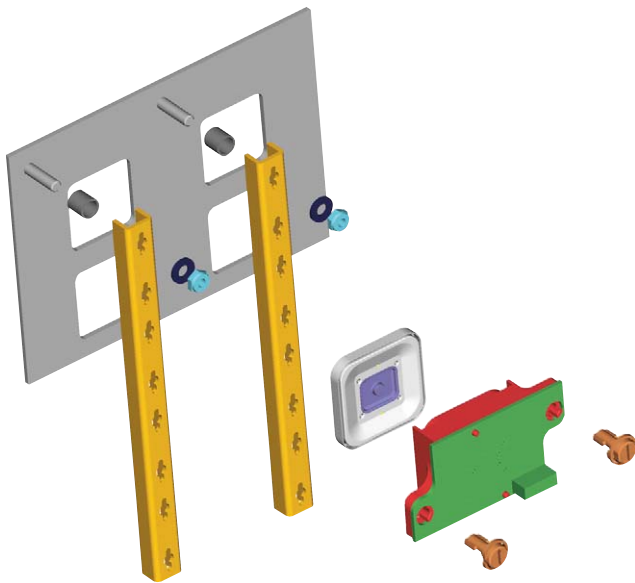

Keylock Switch Features

- Round or square design and lens shape
- Edge illumination in one or two colours with 4 LED for each colour
- Lens material: Aluminum or stainless steel with plastic inlays
- Contact arrangement: 1 NO
- Cylinder lock with pin tumblers
- Two switching positions: 0 and 90 degrees, key can be removed in any position
- Lock type 5201 – other lock types on request
- Included: 2 keys

Micro-Match Connector Pin Assignment

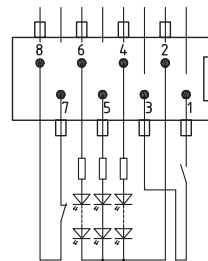

1/3 NO contact

2 OV – LED

4 Edge illuminat./signal indicator
1st colour + 24 V DC +/- 20%

5 Symbol illumination
+ 24 V DC±20%

6 Edge illuminat./signal indicator
2nd colour + 24 V DC +/- 20%

7/8 NC contact

Pushbutton Features

- Round or square design and lens shape
- Edge illumination in one or two colours with 4 LED for each colour
- Additional illumination of the symbol with 2 LED
- Lens material: Aluminum or stainless steel with plastic inlays
- Switching element: short-travel key switch RF 19
 - 1 NO contact, non-illuminated
 - 1 NO contact, fully illuminated

Signal Indicator Features

- Lens shape round, square or triangular (arrow shape)
- Lens material: Translucent plastic material
- Fully illuminated with 5 LED

PCB KEY SWITCHES

RG 85 III - PUSHBUTTONS/KEYS

Installation plan

Rail fixing method

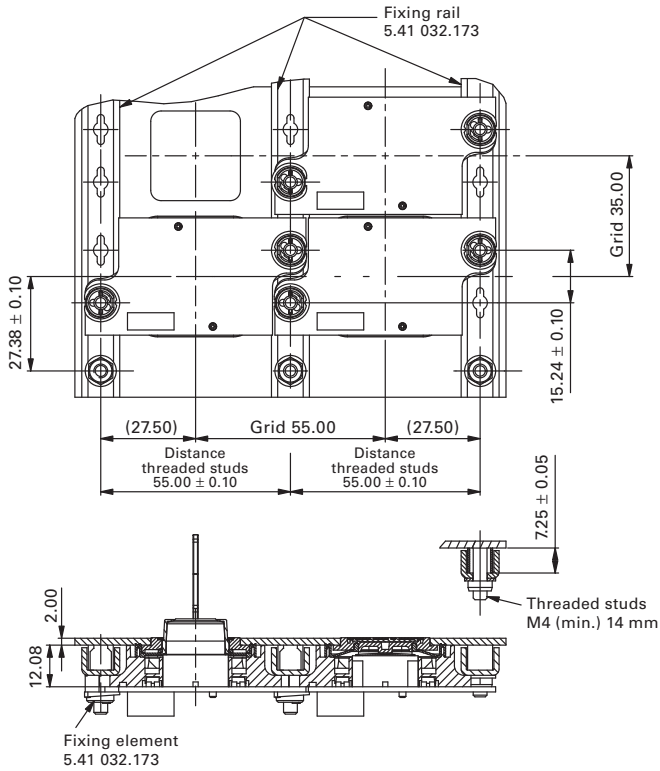

Single fixing method

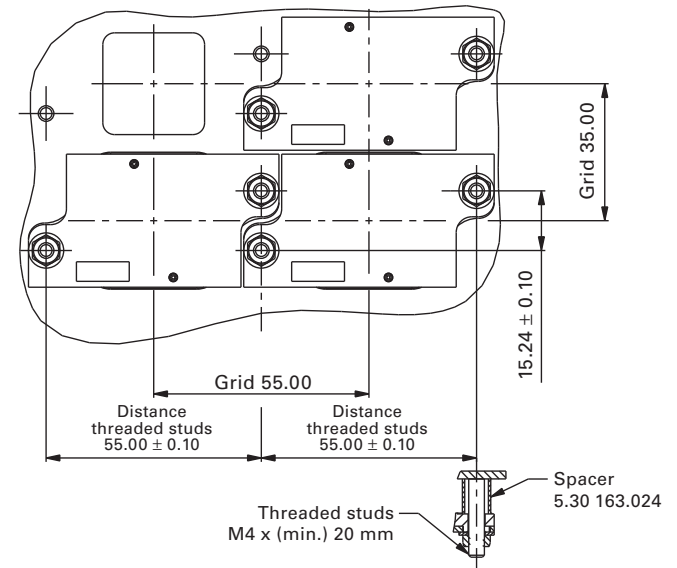

4

Front panel

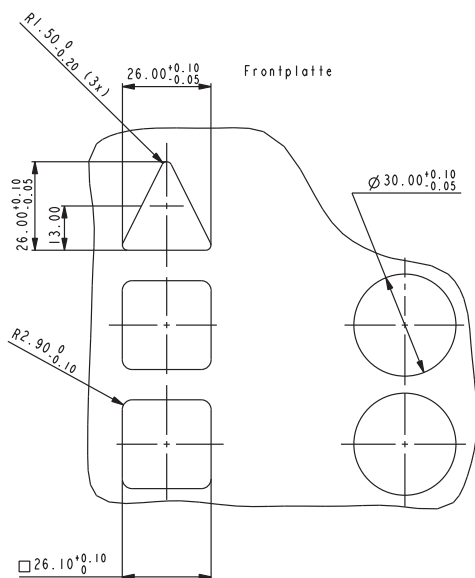

RG 85 III

RG 85 III Key switches

Technical Data

→ Dimensions	
Length	64 mm
Mounting grid min.	55 x 35 mm
Width	34 mm
→ Mechanical design	
Version	see order block
Mounting	on U-rails or single mounting
Terminals	8-pin Micro-Match® female connector
Contact system	snap-action contact
Contact arrangement	see order block
Contact materials	Ag
Symbol illumination	see order block
Edge illumination	see order block
→ Mechanical characteristics	
Operating force	3.5 N
Operating travel	1 mm
Switching travel NO	1 mm
Switching travel NC	0.6 mm
→ Electrical characteristics	
Rated voltage min.	3 V
Rated voltage max.	35 V
Rated current min.	0.1 mA
Rated current max.	250 mA
Rated power max.	12.5 W
Contact resistance when new max.	100 mΩ
Contact resistance acc. to life max.	3 Ω
Bouncing time max.	10 ms
Operating voltage for LED	24 ^{+20%} V
Input current LED	per color/LED row 9 - 16 mA
→ Other specifications	
Ambient temp. operating min.	-25 °C
Ambient temp. operating max.	+70 °C
Storage temperature min.	-40 °C
Storage temperature max.	+80 °C
Environmental resistance	acc. to IEC 60068-2-14, -30, -33 and -78
Operating life min. (operations)	1,000,000
Degree of protection rail mounting	IP40 (DIN EN 60529)
Degree of protection single mounting	IP65 (DIN EN 60529)
Flammability of materials	according to UL 94 HB
ROHS compliant	yes
REACH compliant	yes

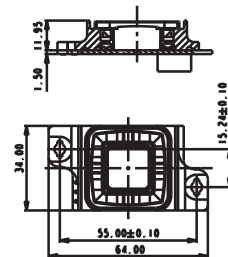

Accessories RG 85 III - Key switch

Description	Photo	Order no.	Additional accessories see page
Cable, 8 wires, with socket connectors on both ends, length 1 m		5.03.772.261/0000	4 - 141
RG 85 III - Lenses for key switches, round, stainless steel		5.04.914.000/2000	4 - 133
RG 85 III - Lenses for key switches, square, aluminum		5.04.915.100/2000	4 - 134

PCB KEY SWITCHES

RG 85 III - PUSHBUTTONS/KEYS

– Table (continued) –
RG 85 III - Key switch, square design, without lens

→ Contact arrangement	Edge illumination	Symbol illumination	Version	Order no.
1 NO	4 LED green	2 LED green	square	3.99.400.112/5500
1 NO	4 LED blue	2 LED blue	square	3.99.400.112/6600
1 NO	4 LED white, 4 LED blue	2 LED blue	square	3.99.400.112/7600
1 NO	4 LED green, 4 LED red	2 LED red	square	3.99.400.112/8300

Please order lenses (square shape) separately.

PCB KEY SWITCHES

RG 85 III - KEYLOCK SWITCHES

RG 85 III Keylock switches

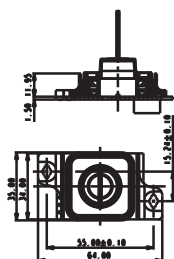

Technical Data

→ Dimensions

Length	64 mm
Mounting grid min.	55 x 35 mm
Width	34 mm (35 mm with sealing)

→ Mechanical design

Version	see order block
Mounting	on U-rails or single mounting
Terminals	8-pin Micro-Match® female connector
Contact system	cross contact
Contact arrangement	1 NO
Contact materials	Au alloy
Symbol illumination	none
Edge illumination	see order block
Lock	cylinder lock, lock type 5201
Key removal position	Pos. 0 + 1

→ Mechanical characteristics

Rotating angle	1 x 90°
Switching travel NO	1 mm

→ Electrical characteristics

Rated voltage min.	3 V
Rated voltage max.	35 V
Rated current min.	0.1 mA
Rated current max.	100 mA
Rated power max.	1 W
Contact resistance when new max.	100 mΩ
Contact resistance acc. to life max.	3 Ω
Bouncing time max.	10 ms
Operating voltage for LED	24 ^{+20%} V
Input current LED	per color/LED row 9 - 16 mA

→ Other specifications

Ambient temp. operating min.	-25 °C
Ambient temp. operating max.	+70 °C
Storage temperature min.	-40 °C
Storage temperature max.	+80 °C
Environmental resistance	acc. to IEC 60068-2-14, -30, -33 and -78
Operating life min. (operations)	50,000
Degree of protection rail mounting	IP40 (DIN EN 60529)
Degree of protection single mounting	IP65 (DIN EN 60529)
Flammability of materials	according to UL 94 HB
ROHS compliant	yes
REACH compliant	yes

4

Accessories RG 85 III - Keylock switch

→ Description

RG 85 III - Lenses for keylock switches, round, stainless steel



Order no.

5.04.914.200/2000

Additional accessories see page

4 - 139

RG 85 III - Lenses for keylock switches, square, aluminum



Order no.

5.04.915.201/2000

4 - 139

RG
85 III

RG 85 III Keylock switch, round design, without lens

Technical data see page 4 - 128

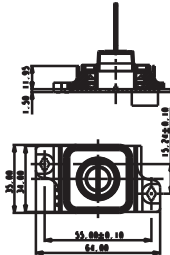

→ Contact arrangement	Edge illumination	Rotating angle	Version	Order no.
1 NO	4 LED white	1 x 90°	round	3.99.400.141/2000
1 NO	4 LED red	1 x 90°	round	3.99.400.141/3000
1 NO	4 LED green	1 x 90°	round	3.99.400.141/5000
1 NO	4 LED blue	1 x 90°	round	3.99.400.141/6000

Please order lenses (round shape) separately.

Accessoires:

RG 85 III - Lenses for keylock switches, round, stainless steel: 5.04.914.200/2000

RG 85 III Keylock switch, square design, without lens

Technical data see page 4 - 128

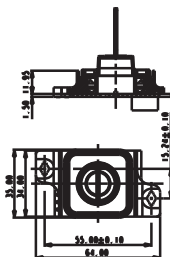

→ Contact arrangement	Edge illumination	Rotating angle	Version	Order no.
1 NO	4 LED white	1 x 90°	square	3.99.400.142/2000
1 NO	4 LED red	1 x 90°	square	3.99.400.142/3000
1 NO	4 LED green	1 x 90°	square	3.99.400.142/5000
1 NO	4 LED blue	1 x 90°	square	3.99.400.142/6000

PCB KEY SWITCHES

RG 85 III - KEYLOCK SWITCHES

– Table (continued) –

RG 85 III - Keylock switch, square design, without lens

Please order lenses (square shape) separately.

Accessoires:

RG 85 III - Lenses for keylock switches, square, stainless steel: 5.04.914.201/2000

RG 85 III Signal indicators, without lens

Technical Data

→ Dimensions	
Length	64 mm
Mounting grid min.	55 x 35 mm
Width	34 mm
→ Mechanical design	
Version	according to lens
Mounting	on U-rails or single mounting
Terminals	8-pin Micro-Match® female connector
Illumination	see order block
→ Electrical characteristics	
Operating voltage for LED	24 ^{±20%} V
Input current LED	depending on LED color 20 - 30 mA
→ Other specifications	
Ambient temp. operating min.	-25 °C
Ambient temp. operating max.	+70 °C
Storage temperature min.	-40 °C
Storage temperature max.	+80 °C
Environmental resistance	acc. to IEC 60068-2-14, -30, -33 and -78
Degree of protection rail mounting	IP40 (DIN EN 60529)
Degree of protection single mounting	IP65 (DIN EN 60529)
Flammability of materials	according to UL 94 HB
ROHS compliant	yes
REACH compliant	yes

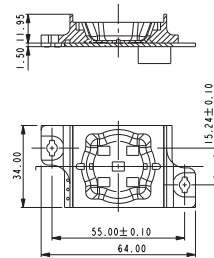

Accessories RG 85 III - Signal indicator, without lens

→ Description	Photo	Order no.	Additional accessories see page
Cable, 8 wires, with socket connectors on both ends, length 2 m		5.03.772.262/0000	4 - 141
RG 85 III - Lens, square, for signal indicators		5.04.903.009/0000	4 - 140
RG 85 III - Lens, round, for signal indicators		5.04.903.010/0000	4 - 140
RG 85 III - Lens, triangular, for signal indicators		5.04.903.011/0000	4 - 141

PCB KEY SWITCHES

RG 85 III - SIGNAL INDICATOR

RG 85 III Signal indicator, without lens

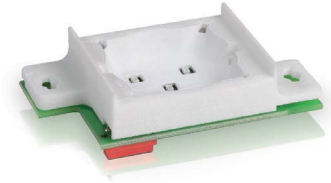

Technical data see page 4 - 131

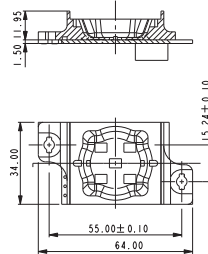

→ Illumination	Order no.
5 LED white	3.99.400.100/2000
5 LED red	3.99.400.100/3000
5 LED green	3.99.400.100/5000
5 LED green, 5 LED red	3.99.400.100/8000

Please order round, square or triangular lenses separately.

RG 85 III Accessories



RG 85 III Lens for key switches, round



→ Version	Form of lens	Legending color	Legending	Order no.
aluminum	round	-	-	5.04.915.000/2000
stainless steel	round	-	-	5.04.914.000/2000

The lenses without legending can not be engraved - other than the mentioned legends on request.

PCB KEY SWITCHES

RG 85 III - SPECIAL ACCESSORIES

RG 85 III Lens for key switches, square



→ Version	Form of lens	Legending color	Legending	Order no.
aluminum	square	-	-	5.04.915.100/2000
stainless steel	square	-	-	5.04.914.100/2000
stainless steel	square	opaque yellow	symbol „bell“	5.04.914.124/0400
stainless steel	square	opaque black	1	5.04.914.101/0100
stainless steel	square	opaque black	2	5.04.914.102/0100
stainless steel	square	opaque black	3	5.04.914.103/0100
stainless steel	square	opaque black	4	5.04.914.104/0100
stainless steel	square	opaque black	5	5.04.914.105/0100
stainless steel	square	opaque black	6	5.04.914.106/0100
stainless steel	square	opaque black	U	5.04.914.121/0100
stainless steel	square	opaque black	K	5.04.914.122/0100
stainless steel	square	opaque black	E	5.04.914.123/0100
stainless steel	square	opaque black	symbol „open door“	5.04.914.125/0100
stainless steel	square	opaque black	symbol „close door“	5.04.914.126/0100
stainless steel	square	opaque black	symbol „ventilator“	5.04.914.127/0100
stainless steel	square	opaque black	symbol „arrow“	5.04.914.128/0100
stainless steel	square	translucent white	1	5.04.914.101/2000
stainless steel	square	translucent white	2	5.04.914.102/2000
stainless steel	square	translucent white	3	5.04.914.103/2000
stainless steel	square	translucent white	4	5.04.914.104/2000
stainless steel	square	translucent white	5	5.04.914.105/2000
stainless steel	square	translucent white	6	5.04.914.106/2000
stainless steel	square	translucent white	U	5.04.914.121/2000
stainless steel	square	translucent white	K	5.04.914.122/2000
stainless steel	square	translucent white	E	5.04.914.123/2000
stainless steel	square	translucent white	symbol „open door“	5.04.914.125/2000
stainless steel	square	translucent white	symbol „close door“	5.04.914.126/2000
stainless steel	square	translucent white	symbol „ventilator“	5.04.914.127/2000
stainless steel	square	translucent white	symbol „arrow“	5.04.914.128/2000

4

RG
85 III

– Table (continued) –
RG 85 III - Lenses for key switches, square

The lenses without legending can not be engraved - other than the mentioned legends on request.

RG 85 III Lens for key switches, round flush, elevator standard EN 81-70



→ Version	Form of lens	Legending color	Legending	Order no.
stainless steel	round	-	-	5.04.916.000/2000
stainless steel	round	opaque yellow	symbol „bell“	5.04.916.024/1404
stainless steel	round	translucent white	1	5.04.916.001/2000
stainless steel	round	translucent white	2	5.04.916.002/2000
stainless steel	round	translucent white	3	5.04.916.003/2000
stainless steel	round	translucent white	4	5.04.916.004/2000
stainless steel	round	translucent white	5	5.04.916.005/2000
stainless steel	round	translucent white	6	5.04.916.006/2000
stainless steel	round	translucent white	U	5.04.916.021/2000
stainless steel	round	translucent white	K	5.04.916.022/2000
stainless steel	round	translucent white	E	5.04.916.023/2000
stainless steel	round	translucent white	symbol „open door“	5.04.916.025/2000
stainless steel	round	translucent white	symbol „close door“	5.04.916.026/2000
stainless steel	round	translucent white	symbol „arrow“	5.04.916.033/2000
stainless steel	round	translucent white	symbol „ventilator“	5.04.916.034/2000
stainless steel	round	translucent white	7	5.04.916.007/2000
stainless steel	round	translucent white	8	5.04.916.008/2000
stainless steel	round	translucent white	9	5.04.916.009/2000
stainless steel	round	translucent white	10	5.04.916.010/2000
stainless steel	round	translucent white	11	5.04.916.011/2000
stainless steel	round	translucent white	12	5.04.916.012/2000
stainless steel	round	translucent white	13	5.04.916.013/2000
stainless steel	round	translucent white	14	5.04.916.014/2000
stainless steel	round	translucent white	15	5.04.916.015/2000

PCB KEY SWITCHES

RG 85 III - SPECIAL ACCESSORIES

– Table (continued) –

RG 85 III - Lenses for key switches, round flush, elevator standard EN 81-70

→ Version	Form of lens	Legending color	Legending	Order no.
stainless steel	round	translucent white	16	5.04.916.016/2000
stainless steel	round	translucent white	17	5.04.916.017/2000
stainless steel	round	translucent white	18	5.04.916.018/2000
stainless steel	round	translucent white	19	5.04.916.019/2000
stainless steel	round	translucent white	20	5.04.916.020/2000
stainless steel	round	translucent white	0	5.04.916.027/2000
stainless steel	round	translucent white	-1	5.04.916.028/2000
stainless steel	round	translucent white	-2	5.04.916.029/2000
stainless steel	round	translucent white	-3	5.04.916.030/2000
stainless steel	round	translucent white	-4	5.04.916.031/2000
stainless steel	round	translucent white	-5	5.04.916.032/2000
stainless steel	round	transparent yellow	symbol „bell“	5.04.916.024/2214



RG 85 III Lens for key switches, round protruding, elevator standard EN 81-70

4

→ Version	Form of lens	Legending color	Legending	Order no.
stainless steel	round	opaque yellow	symbol „bell“	5.04.916.224/1404
stainless steel	round	opaque black	-	5.04.916.201/1501
stainless steel	round	opaque black	2	5.04.916.202/1501
stainless steel	round	opaque black	3	5.04.916.203/1501
stainless steel	round	opaque black	E	5.04.916.223/1501
stainless steel	round	opaque black	0	5.04.916.227/1501
stainless steel	round	opaque black	-1	5.04.916.228/1501
stainless steel	round	transparent yellow	symbol „bell“	5.04.916.224/2214

RG
85 III

RG 85 III Lens for key switches, square flush, elevator standard EN 81-70



→ Version	Form of lens	Legending color	Legending	Order no.
stainless steel	square	-	-	5.04.916.100/2000
stainless steel	square	opaque yellow	symbol „bell“	5.04.916.124/1404
stainless steel	square	translucent white	1	5.04.916.101/2000
stainless steel	square	translucent white	2	5.04.916.102/2000
stainless steel	square	translucent white	3	5.04.916.103/2000
stainless steel	square	translucent white	4	5.04.916.104/2000
stainless steel	square	translucent white	5	5.04.916.105/2000
stainless steel	square	translucent white	6	5.04.916.106/2000
stainless steel	square	translucent white	U	5.04.916.121/2000
stainless steel	square	translucent white	K	5.04.916.122/2000
stainless steel	square	translucent white	E	5.04.916.123/2000
stainless steel	square	translucent white	symbol „open door“	5.04.916.125/2000
stainless steel	square	translucent white	symbol „close door“	5.04.916.126/2000
stainless steel	square	translucent white	symbol „arrow“	5.04.916.133/2000
stainless steel	square	translucent white	symbol „ventilator“	5.04.916.134/2000
stainless steel	square	translucent white	7	5.04.916.107/2000
stainless steel	square	translucent white	8	5.04.916.108/2000
stainless steel	square	translucent white	9	5.04.916.109/2000
stainless steel	square	translucent white	10	5.04.916.110/2000
stainless steel	square	translucent white	11	5.04.916.111/2000
stainless steel	square	translucent white	12	5.04.916.112/2000
stainless steel	square	translucent white	13	5.04.916.113/2000
stainless steel	square	translucent white	14	5.04.916.114/2000
stainless steel	square	translucent white	15	5.04.916.115/2000
stainless steel	square	translucent white	16	5.04.916.116/2000
stainless steel	square	translucent white	17	5.04.916.117/2000
stainless steel	square	translucent white	18	5.04.916.118/2000
stainless steel	square	translucent white	19	5.04.916.119/2000
stainless steel	square	translucent white	20	5.04.916.120/2000

PCB KEY SWITCHES

RG 85 III - SPECIAL ACCESSORIES

– Table (continued) –

RG 85 III - Lenses for key switches, square flush, elevator standard EN 81-70

→ Version	Form of lens	Legending color	Legending	Order no.
stainless steel	square	translucent white	0	5.04.916.127/2000
stainless steel	square	translucent white	-1	5.04.916.128/2000
stainless steel	square	translucent white	-2	5.04.916.129/2000
stainless steel	square	translucent white	-3	5.04.916.130/2000
stainless steel	square	translucent white	-4	5.04.916.131/2000
stainless steel	square	translucent white	-5	5.04.916.132/2000
stainless steel	square	transparent yellow	symbol „bell“	5.04.916.124/2214



RG 85 III Lens for key switches, square protruding, elevator standard EN 81-70

4

→ Version	Form of lens	Legending color	Legending	Order no.
stainless steel	square	opaque yellow	symbol „bell“	5.04.916.254/1404
stainless steel	square	opaque black	1	5.04.916.231/1501
stainless steel	square	opaque black	2	5.04.916.232/1501
stainless steel	square	opaque black	3	5.04.916.233/1501
stainless steel	square	opaque black	E	5.04.916.253/1501
stainless steel	square	opaque black	0	5.04.916.257/1501
stainless steel	square	opaque black	-1	5.04.916.258/1501
stainless steel	square	transparent yellow	symbol „bell“	5.04.916.254/2214

RG
85 III

RG 85 III Lens for keylock switches, round



→ Version	Form of lens	Legending color	Legending	Order no.
aluminum	round	-	-	5.04.915.200/2000
stainless steel	round	-	-	5.04.914.200/2000

RG 85 III Lens for keylock switches, square



→ Version	Form of lens	Legending color	Legending	Order no.
aluminum	square	-	-	5.04.915.201/2000
stainless steel	square	-	-	5.04.914.201/2000

PCB KEY SWITCHES

RG 85 III - SPECIAL ACCESSORIES

RG 85 III Lens, round, for signal indicators



→ Version	Form of lens	Legending color	Legending	Order no.
plastic translucent	round	-	-	5.04.903.010/0000

RG 85 III Lens, square, for signal indicators



→ Version	Form of lens	Legending color	Legending	Order no.
plastic translucent	square	-	-	5.04.903.009/0000

4

RG
85 III

RG 85 III Lens, triangular, for signal indicators



→ Version	Form of lens	Legending color	Legending	Order no.
plastic translucent	triangular	-	-	5.04.903.011/0000

Cable, 8 wire, with socket connectors on both ends



→ Version	Order no.
length: 1 m	5.03.772.261/0000
length: 2 m	5.03.772.262/0000

PCB KEY SWITCHES

RG 85 III - SPECIAL ACCESSORIES

Fixing rail, length 490 mm



→ **Version**

Order no.

length: 490 mm

5.41.032.173/7500



Spacer

→ **Version**

Order no.

mounting on rails

5.30.163.021/6000

single mounting

5.30.163.024/6000



Fixing piece for mounting the elements with the rail fixing method

→ **Description**

Order no.

Fixing piece for mounting the elements with the rail fixing method

5.55.104.208/0459

4

RG
85 III

PCB KEY SWITCHES

RS 76 - FULL-TRAVEL KEY SWITCHES



RS 76

Full-travel key switches

The RS 76 full-travel key switches are designed for configuring keyboards. They offer very comfortable operation with an overall height of 15.5 / 15.9 mm and a key travel of 4 mm. The modular system with a grid of $3/4" = 19.05$ mm enables you to design any key block you may want.

Mechanical contact system RS 76 M

A gold alloy is used as the contact material and provides high contact reliability, low contact resistance and short bouncing time.

Solid-state contact system RS 76 C

The solid-state switch in Hall-IC technology ensures bounce-free and wear-free switching and a long operating life. Function: When pressing the keys, a permanent magnet changes its position relative to the Hall-IC and thereby generates an output signal. Their use is especially recommended in hostile environments and for heavy duty applications.

- All products are RoHS compliant.

PCB KEY SWITCHES

RS 76 - FULL-TRAVEL KEY SWITCHES

Content

RS 76 M - Full-travel key switches, not illuminable	4 - 150
RS 76 M - Full-travel key switch, not illuminable	4 - 151
RS 76 M - Full-travel key switch, with diode, not illuminable	4 - 152
RS 76 M - Full-travel key switches, illuminable	4 - 153
RS 76 M - Full-travel key switch, illuminable, momentary	4 - 154
RS 76 M - Full-travel key switch, illuminable, latching	4 - 155
RS 76 MX - Full-travel key switch, fully illuminable	4 - 155
RS 76 C - Full-travel key switches, not illuminable	4 - 156
RS 76 C - Full-travel key switch, not illuminable	4 - 157
RS 76 C - Full-travel key switches, illuminable	4 - 158
RS 76 C - Full-travel key switch, illuminable, momentary	4 - 159
RS 76 C - Full-travel key switch, illuminable, latching	4 - 160
RS 76 - Keycaps, not illuminable	4 - 161
RS 76 C - Keycap, opaque	4 - 161
RS 76 C - Keycap, opaque, with nail protection	4 - 162
RS 76 C - Keycap with legend insert	4 - 162
RS 76 - Keycaps, illuminable	4 - 163
RS 76 - Keycap with light bar	4 - 163
RS 76 - Keycap, illuminable, with legend insert	4 - 164
RS 76 - Keycap, illuminable, with nail protection and legend insert	4 - 164
RS 76 - Keycap, illuminable, with legend insert	4 - 165
RS 76 MX - Keycap, fully illuminable	4 - 165
RS 76 - Keycaps, with legend, two-shot molded/keycap sets	4 - 166
RS 76 - Keycap set, symbols A-Z	4 - 166
RS 76 - Keycap set, symbols 0-9	4 - 167
RS 76 - Accessories	4 - 168
RS 76 - Cover IP40	4 - 168

The RAFI full-travel key switches RS 76 are modular systems for designing individual key blocks and keyboards in the 3/4 inch (= 19.05 mm) grid.

Definitions

Momentary key switches

Momentary key switches return to their initial position after being pressed (momentary action).

Latching key switches

Latching key switches lock when actuated and are returned to their initial position when pressed again (push-push action).

Keycap materials

Keycap without legend insert: ABS

Keycap with legend insert:

– Keycap body: ABS

– Lens: PC

Keycap, n-module

A 2-module keycap f. ex. has the twofold length of a 1-module keycap.

Contact principle

There are two contact principles:

– **Mechanical (M):** Cross contact (RS 76 M)
Bridge contact
(RS 76 M, illuminated)

– **Contactless (C):** Based on Hall-IC (RS 76 C)

Manual Soldering

The soldering temperature should not exceed 300 °C and the soldering time should be less than 5 seconds.

Legending of keycaps

Keycaps can be legended by different methods:

Two-shot moulding

Using this method the symbol is separately manufactured from a plastic and then the appropriate keycap form is moulded round it. Advantage: The character becomes an integrated part of the keycap, thus eliminating abrasion. All RAFI keycap sets with standard legending are manufactured by this method.

Customer specific two-shot moulded keycaps on request.

Printing

Keycaps can be printed with a two-component ink on request. The abrasion of this kind of legending is high. This method of legending is suitable for average volumes.

Engraving

In this labour intensive process the keycaps are engraved with the required symbol, then inlaid with ink. Only used for small volumes.

Laser-printing

This method of legending can be recommended when complete keyboards are required in different keyboard layouts for which RAFI will develop the respective software. The keyboards can then be legended within a short time. This method of legending is particularly recommended for average to large volumes.

Legend inserts

In the case of keycaps with replaceable legend inserts it is possible to print or engrave the legend inserts. As these inserts are protected by the lens, there can be no abrasion here either.

PCB KEY SWITCHES

RS 76 M/C - FULL-TRAVEL KEY SWITCHES

Design

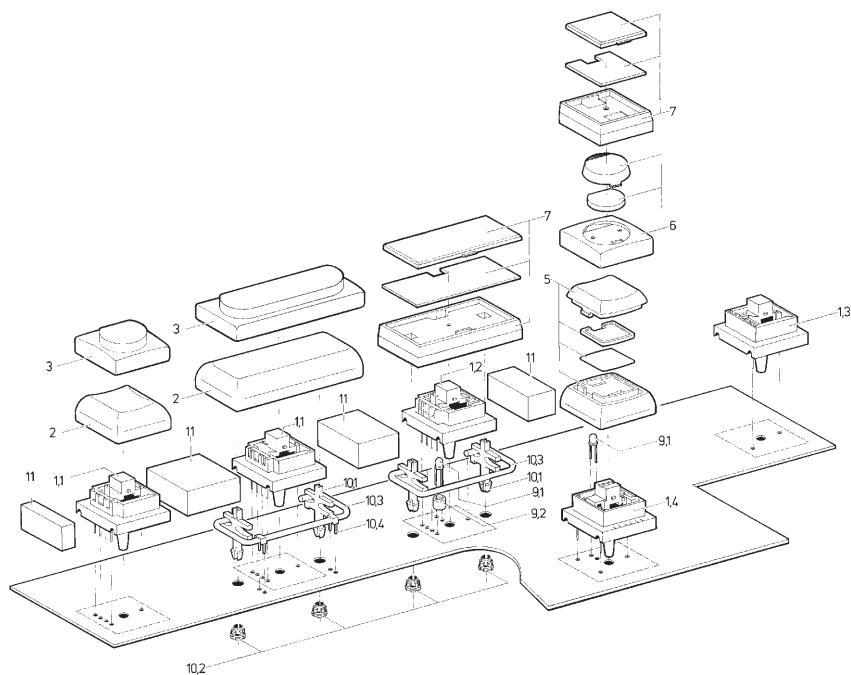

No. Description

- 1.1 Key switch RS 76 C
- 1.2 Key switch RS 76 C with LED
- 1.3 Key switch RS 76 M
- 1.4 Key switch R 76 M with LED
- 2 Keycap, 1- resp. multi-module
- 3 Keycap with nail protection, 1- resp. multi-module
- 5 Keycap, illuminated
- 6 Keycap, illuminated
- 7 Keycap, illuminated
- 9.1 LED
- 9.2 Spacer for LED (for RS 76 C only)
- 10.1 Plunger for multi-moduel keycaps*
- 10.2 Sleeve for multi-moduel keycaps*
- 10.3 Metal lever for multi-module keycaps*
- 10.4 Bearing bracket for multi-module keycaps*
- 11 Covers

* These parts are included as a complete packet in the delivery of keycaps \geq 2-module.

4

Hole pattern PCB RS 76 M/C

The hole patterns apply to the horizontal position of the keycaps only. Should they be in a vertical position,

the momentary key switch must be mounted accordingly, i. e. rotated by 90°.

For 1 – 13/4-module keycaps (view on component side)

Momentary key switch, non-illuminated

RS 76 M

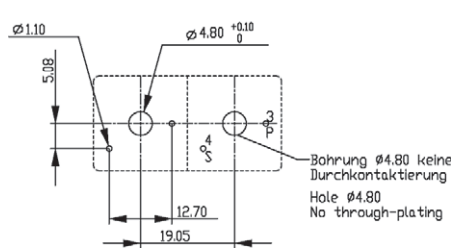

Momentary key switch, non-illuminated

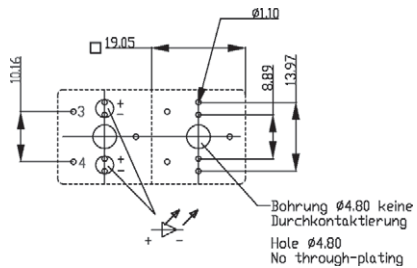

RS 76 C

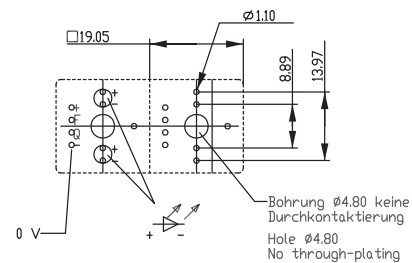
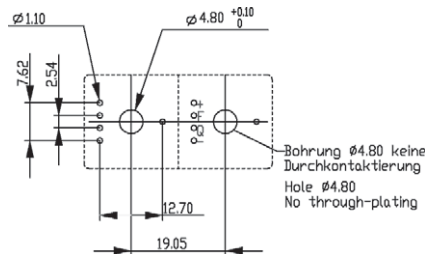

For 2-, 3- and 8-module keycaps (view on component side)

Momentary key switch, non-illuminated

RS 76 M/C

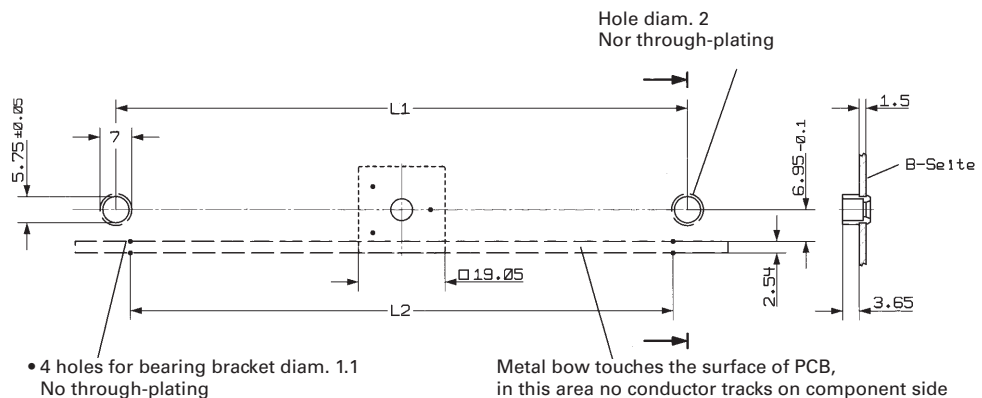

Keycap	L 1 mm	L 2 mm
2-module	25.40	22.86
3-module	30.48	24.13
5-module	68.58	68.58

Important note: In the case of 2-, 3- and 8-module keycaps, additional holes must be provided for the accessories. In the case of keycaps < 2-module, neither accessories nor holes are required.

PCB KEY SWITCHES

RS 76 M/C - FULL-TRAVEL KEY SWITCHES

Specific technical data RS 76 C

Output pulse diagram Dynamic characteristics (max.)		$T_w = 25\text{ }^\circ\text{C}$	$T_w = 50\text{ }^\circ\text{C}$	$T_w = 70\text{ }^\circ\text{C}$
Turn-on delay time	t_{PHL}	3 μs	7 μs	10 μs
Turn-off delay time	t_{PHL}	4 μs	5 μs	6 μs
Fall/rise time	t_{PHL}	2 μs	2,5 μs	3 μs
	t_{PHL}	1 μs	1,5 μs	2,5 μs

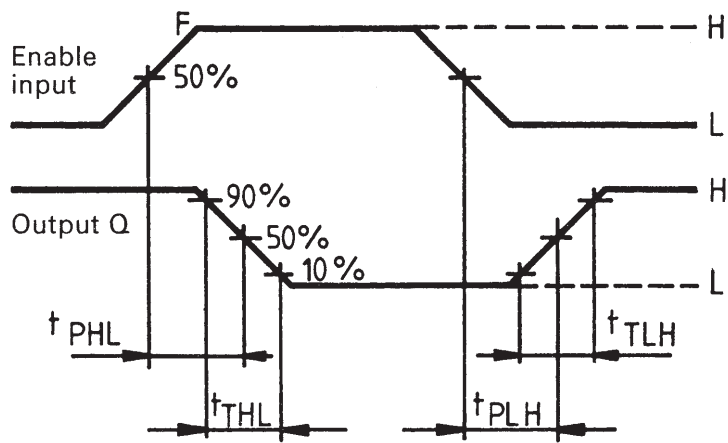

4

Block diagram
Hall IC

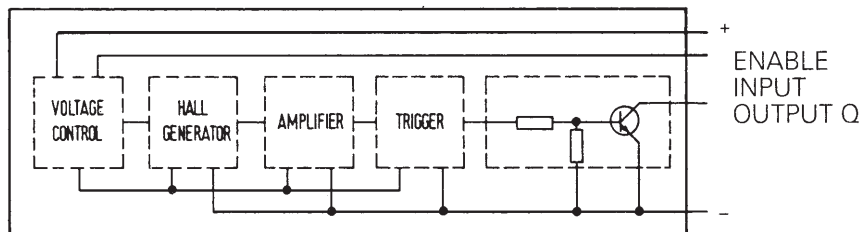

Static with Enable Input

Examples for application RS 76 C

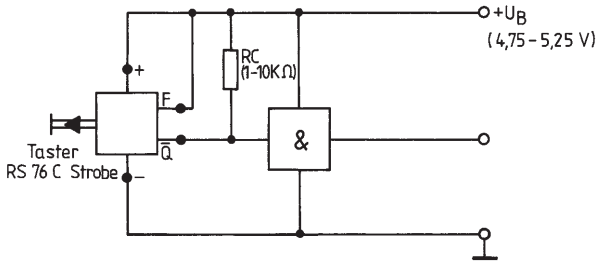

Driving of logic components

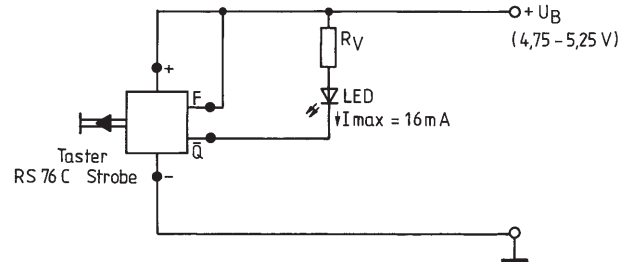

Indication of logical states

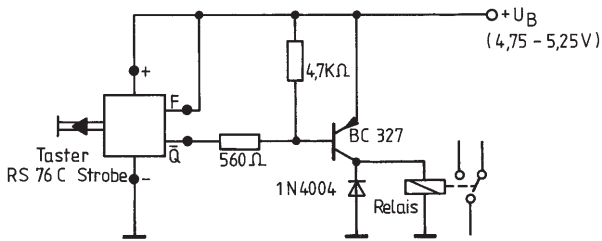

Driving of a PNP transistor

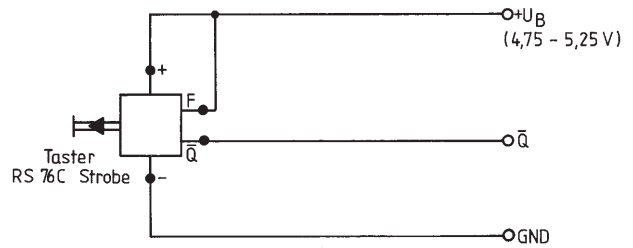

Use as static key with open collector output.
Output transistor (NPN) is conductive when actuated.

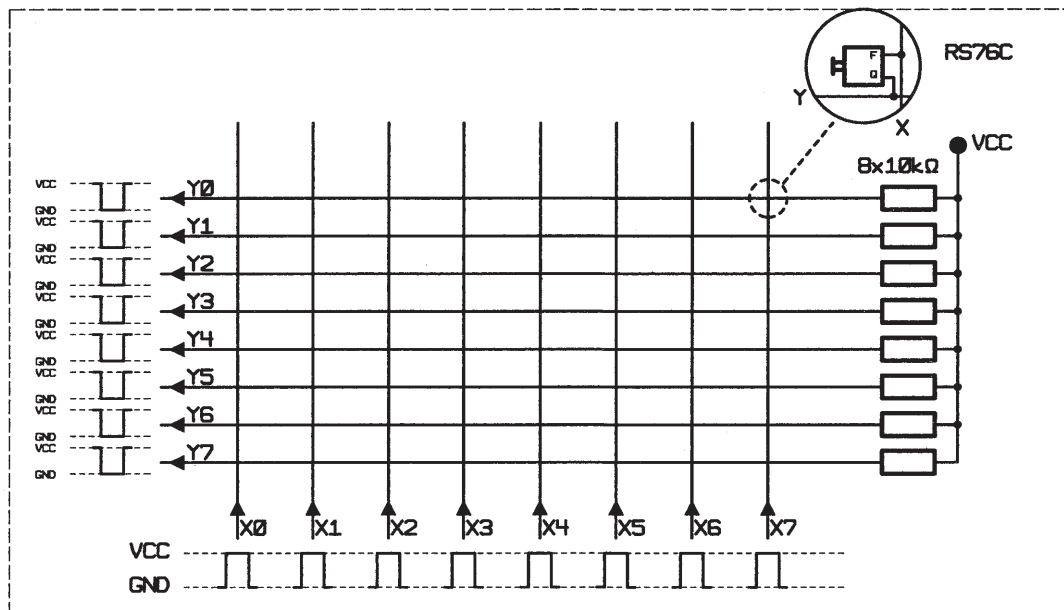

Use in keyboards

PCB KEY SWITCHES

RS 76 M - FULL-TRAVEL KEY SWITCHES, NON-ILLUMINATED

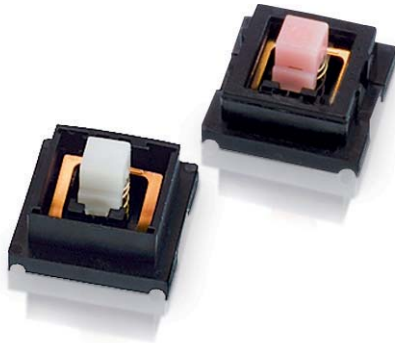

RS 76 M Full-travel key switches, not illuminable

Technical Data

→ General information	
Recommended key grid	19.05 mm
→ Mechanical design	
Contact function	momentary
Mounting	soldering
Terminals	solder terminals, tin-plated
Contact system	cross contact
Contact arrangement	1 NO
Contact materials	Au alloy
Illumination	no
→ Mechanical characteristics	
Operating force max.	see order block
Operating travel	4 mm
Switching travel	1.5 - 2.8 mm
Robustness max.	100 N
→ Electrical characteristics	
Rated voltage min.	2 V (with Diode 3 V)
Rated voltage max.	35 V
Rated current min.	0.01 mA
Rated current max.	100 mA
Rated power max.	1 W
Contact resistance when new max.	100 mΩ (ohne Diode)
Contact resistance acc. to life max.	3 Ω (without diode)
Insulation resistance	10 ⁹ Ω
ESD strength max.	8 kV
Bouncing time max.	5 ms
→ Other specifications	
Ambient temp. operating min.	-25 °C
Ambient temp. operating max.	+70 °C
Storage temperature min.	-40 °C
Storage temperature max. (product)	+80 °C
Storage temperature max. (rail)	+50 °C
Environmental resistance	acc. to IEC 60068-2-14, -30, -33 and -78
Operating life min. (operations)	10 ⁷
Degree of protection	IP40 (DIN EN 60529)
Flammability of materials	UL 94 HB
ROHS compliant	yes
REACH compliant	yes

4

Accessories RS 76 M - Full-travel key switch, not illuminable

→ Description	Photo	Order no.	Additional accessories see page
RS 76 C - Keycap with legend insert		-	4 - 162
RS 76 C - Keycap, opaque		-	4 - 161

RS
76

PCB KEY SWITCHES

RS 76 M - FULL-TRAVEL KEY SWITCHES, NON-ILLUMINATED

**- Table (continued) -
Accessories RS 76 M - Full-travel key switch, not illuminable**

→ Description	Photo	Order no.	Additional accessories see page
RS 76 C - Keycap, opaque, with nail protection		-	4 - 162

RS 76 M Full-travel key switch, not illuminable



Technical data see page 4 - 150

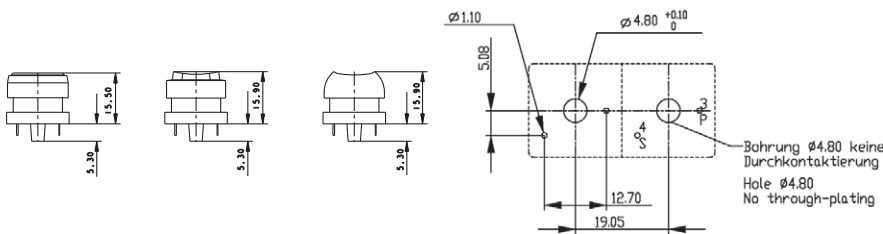

→ Contact function	Illumination	Contact arrangement	Contact materials	Operating travel	Operating force max.	Order no.
momentary	no	1 NO	Au alloy	4 mm	0.9 N	3.13.002.502/0000
momentary	no	1 NO	Au alloy	4 mm	1.4 N	3.13.002.512/0000

For accessories, refer to RS 76 special accessories.

For keycaps, see keycaps for RS 76.

PCB KEY SWITCHES

RS 76 M - FULL-TRAVEL KEY SWITCHES, NON-ILLUMINATED

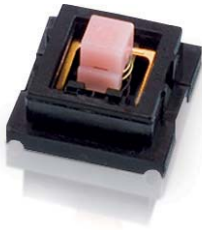

RS 76 M Full-travel key switch, with diode, not illuminable

Technical data see page 4 - 150

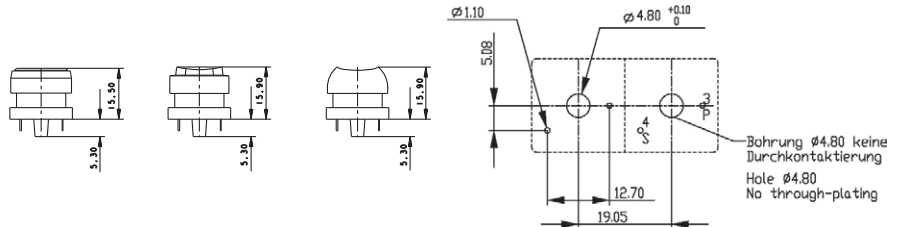

→ Contact function	Illumination	Contact arrangement	Contact materials	Operating travel	Operating force max.	Order no.
momentary	no	1 NO	Au alloy	4 mm	0.9 N	3.13.005.001/0000
momentary	no	1 NO	Au alloy	4 mm	1.4 N	3.13.005.011/0000

For accessories, refer to RS 76 special accessories.

For keycaps, see keycaps for RS 76.

RS 76 M Full-travel key switches, illuminable

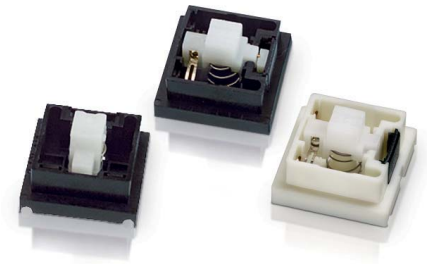

RS 76MX, with illuminated keycaps

Technical Data

→ General information

Recommended key grid	19.05 mm
----------------------	----------

→ Mechanical design

Contact function	see order block
Mounting	soldering
Terminals	solder terminals, tin-plated
Contact system	bridge contact
Contact arrangement	1 NO
Contact materials	Au alloy
Illumination	see order block

→ Mechanical characteristics

Operating force max.	1 N
Operating travel	4 mm
Switching travel	1.5 - 2.8 mm
Robustness max.	100 N

→ Electrical characteristics

Rated voltage min.	2 V
Rated voltage max.	35 V
Rated current min.	0.01 mA
Rated current max.	100 mA
Rated power max.	1 W
Contact resistance when new max.	200 mΩ
Contact resistance acc. to life max.	3 Ω
Insulation resistance	10 ⁹ Ω
ESD strength max.	8 kV
Bouncing time max.	10 ms

→ Other specifications

Ambient temp. operating min.	-25 °C
Ambient temp. operating max.	+70 °C
Storage temperature min.	-40 °C
Storage temperature max. (product)	+80 °C
Storage temperature max. (rail)	+50 °C
Environmental resistance	acc. to IEC 60068-2-14, -30, -33 and -78
Operating life min. (operations)	10 ⁷ momentary, 10 ⁵ latching
Degree of protection	IP40 (DIN EN 60529)
Flammability of materials	UL 94 HB
ROHS compliant	yes
REACH compliant	yes

Accessories RS 76 M - Full-travel key switch, illuminable

→ Description	Photo	Order no.	Additional accessories see page
RS 76 - Cover IP40		-	4 - 168
RS 76 - Keycap with light bar		-	4 - 163
RS 76 - Keycap, illuminable, with legend insert		-	4 - 164

PCB KEY SWITCHES

RS 76 M - FULL-TRAVEL KEY SWITCHES, ILLUMINATED

– Table (continued) –

Accessories RS 76 M - Full-travel key switch, illuminable

→ Description	Photo	Order no.	Additional accessories see page
RS 76 - Keycap, illuminable, with nail protection and legend insert		-	4 - 164



RS 76 M Full-travel key switch, illuminable, momentary

Technical data see page 4 - 153

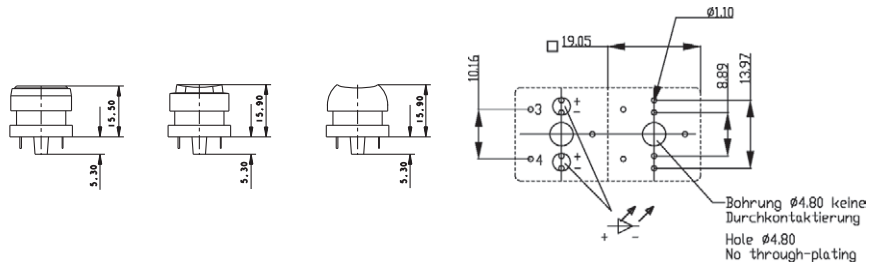

→ Contact function	Contact system	Illumination	Recommended key grid	Order no.
momentary	bridge contact	spot illumination possible with 3 LED	19.05 mm	3.13.002.102/0000

For accessories, refer to RS 76 special accessories.

For keycaps, see keycaps for RS 76.

Accessoires:

THT LED 3 mm, without base: see page 2 - 263, 5 - 8

4

RS
76

RS 76 M Full-travel key switch, illuminable, latching

Technical data see page 4 - 153

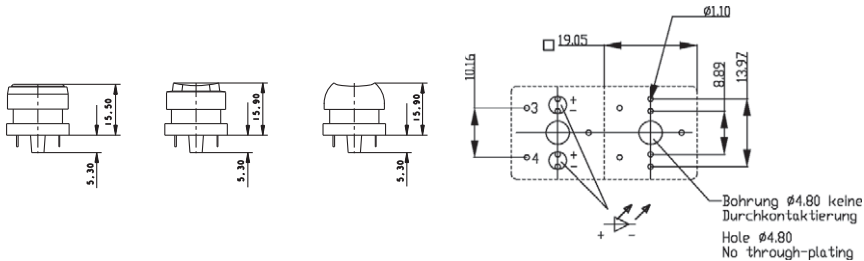

→ Contact function	Contact system	Illumination	Recommended key grid	Order no.
latching	bridge contact	spot illumination possible with 3 LED	19.05 mm	3.13.002.022/0000

For accessories, refer to RS 76 special accessories.

For keycaps, see keycaps for RS 76.

Accessoires:

THT LED 3 mm, without base: see page 2 - 263, 5 - 8

RS 76 MX Full-travel key switch, fully illuminable

Technical data see page 4 - 153

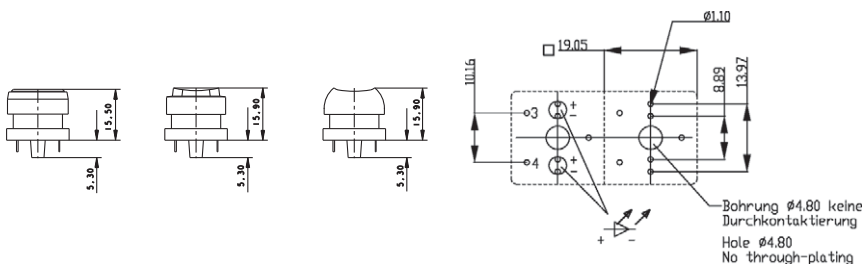

→ Contact function	Contact system	Illumination	Recommended key grid	Order no.
momentary	bridge contact	2 SMT LED needed	19.05 mm	3.13.002.922/0000

For accessories, refer to RS 76 special accessories.

For keycaps, see keycaps for RS 76.

The SMT LEDs are soldered on the back of the printed circuit board and shine through openings in the board and key switch housing.

Accessoires:

RS 76 MX - Keycap, fully illuminated: 5.05.511.168/0209

RS 76 MX - Keycap, fully illuminated: 5.05.511.168/0754

PCB KEY SWITCHES

RS 76 C - FULL-TRAVEL KEY SWITCHES, NON-ILLUMINATED



RS 76 C Full-travel key switches, not illuminable

Technical Data

→ General information

Recommended key grid	19.05 mm
----------------------	----------

→ Mechanical design

Contact function	momentary
Mounting	soldering
Terminals	solder terminals, tin-plated
Contact system	contactless with Hall-IC
Illumination	no

→ Mechanical characteristics

Switching travel off	0.8 ... 2.4 mm
Operating force max.	see order block
Operating travel	4 mm
Switching travel on	1.5 - 2.8 mm
Robustness max.	100 N

→ Electrical characteristics

Operating voltage DC	4.75 ... 5.25 V
Supply current max. at $U_{IL} = 0 V$	0.5 mA
Supply current max. at $U_{IH} = 5 V$	5 mA
Input voltage (F) at $U_{IL} = 0 V$	0.4 V
Input voltage (F) at $U_{IH} = 2.4 V$	5.25 V
Output load current (Q) max.	16 mA
Output residual current (Q) max.	10 μA
Output saturation voltage (Q) max. bei 16 mA	0.4 V
ESD strength max.	8 kV
Output switching times (Q) at 25 °C, t_{PHL}	3 μs
Output switching times (Q) at 25 °C, t_{PLH}	4 μs
Output switching times (Q) at 25 °C, t_{THL}	1 μs
Output switching times (Q) at 25 °C, t_{TLH}	2 μs

→ Other specifications

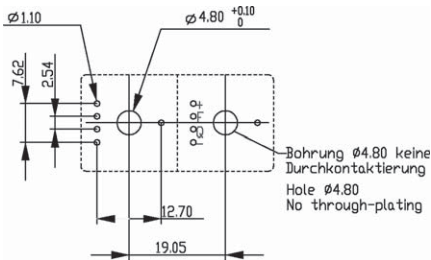
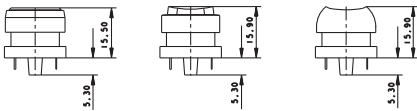

Reliability of Hall-IC at 25 °C	$\lambda = 2.5 \times 10^{-7} h^{-1}$
Ambient temp. operating min.	0 °C
Ambient temp. operating max.	+70 °C
Storage temperature min.	-40 °C
Storage temperature max. (product)	+80 °C
Storage temperature max. (rail)	+50 °C
Environmental resistance	acc. to IEC 60068-2-14, -30, -33 and -78
Operating life min. (operations)	see order block
Degree of protection	IP40 (DIN EN 60529)
Flammability of materials	UL 94 HB
ROHS compliant	yes
REACH compliant	yes



PCB KEY SWITCHES

RS 76 C - FULL-TRAVEL KEY SWITCHES, NON-ILLUMINATED

Accessories RS 76 C - Full-travel key switch, not illuminable

→ Description	Photo	Order no.	Additional accessories see page
RS 76 C - Keycap with legend insert		-	4 - 162
RS 76 C - Keycap, opaque		-	4 - 161
RS 76 C - Keycap, opaque, with nail protection		-	4 - 162

RS 76 C Full-travel key switch, not illuminable

Technical data see page 4 - 156

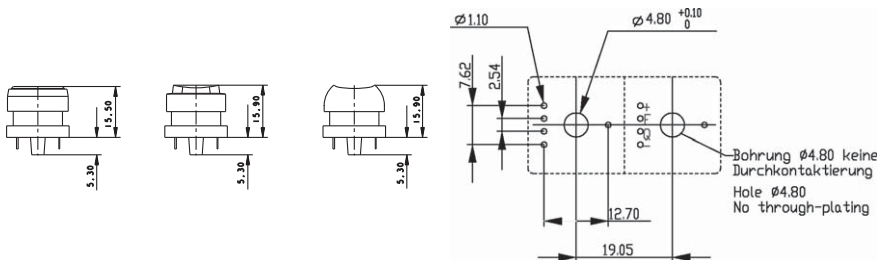

→ Contact function	Operating life min. (operations)	Illumination	Operating force max.	Operating travel	Order no.
momentary	10^8	no	0.7 N	4 mm	3.13.001.010/0000
momentary	10^8	no	1 N	4 mm	3.13.001.210/0000

For accessories and keycaps, refer to RS 76. For applications, refer to the general description of RS 76.

PCB KEY SWITCHES

RS 76 C - FULL-TRAVEL KEY SWITCHES, ILLUMINATED

RS 76 C Full-travel key switches, illuminable

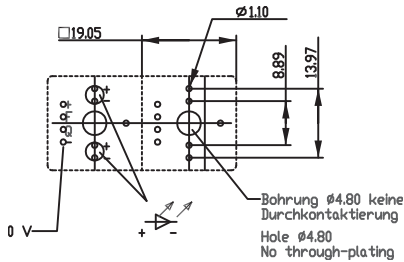
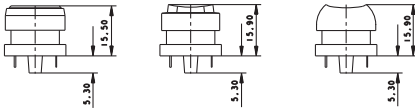

Technical Data

→ General information

Recommended key grid 19.05 mm

→ Mechanical design

Contact function see order block
Mounting soldering
Terminals solder terminals, tin-plated
Contact system contactless with Hall-IC
Illumination with LED
LED color see order block

→ Mechanical characteristics

Switching travel on 1.5 - 2.8 mm
Switching travel off 0.8 ... 2.4 mm
Operating force max. 0.7 N
Operating travel 4 mm
Robustness max. 100 N

→ Electrical characteristics

Number of LED see order block
Operating voltage DC 4.75 ... 5.25 V
Supply current max. at $U_{IL} = 0 V$ 0.5 mA
Supply current max. at $U_{IH} = 5 V$ 5 mA
Input voltage (F) at $U_{IL} = 0 V$ 0.4 V
Input voltage (F) at $U_{IH} = 2.4 V$ 5.25 V
Output load current (Q) max. 16 mA
Output residual current (Q) max. 10 μA
Output saturation voltage (Q) max. bei 16 mA 0.4 V
ESD strength max. 8 kV
Output switching times (Q) at 25 °C, t_{PHL} 3 μs
Output switching times (Q) at 25 °C, t_{PLH} 4 μs
Output switching times (Q) at 25 °C, t_{THL} 1 μs
Output switching times (Q) at 25 °C, t_{TLH} 2 μs

→ Other specifications

Reliability of Hall-IC at 25 °C $\lambda = 2.5 \times 10^{-7} h^{-1}$
Ambient temp. operating min. 0 °C
Ambient temp. operating max. +70 °C
Storage temperature min. -40 °C
Storage temperature max. (product) +80 °C
Storage temperature max. (rail) +50 °C
Environmental resistance acc. to IEC 60068-2-14, -30, -33 and -78
Operating life min. (operations) see order block
Degree of protection IP40 (DIN EN 60529)
Flammability of materials UL 94 HB
ROHS compliant yes
REACH compliant yes

Accessories RS 76 C - Full-travel key switch, illuminable

→ Description

Photo

Order no.

Additional accessories see page

RS 76 - Cover IP40



-

4 - 168



4

RS
76

PCB KEY SWITCHES

RS 76 C - FULL-TRAVEL KEY SWITCHES, ILLUMINATED

– Table (continued) –
Accessories RS 76 C - Full-travel key switch, illuminable

→ Description	Photo	Order no.	Additional accessories see page
RS 76 - Keycap with light bar		-	4 - 163
RS 76 - Keycap, illuminable, with legend insert		-	4 - 164
RS 76 - Keycap, illuminable, with nail protection and legend insert		-	4 - 164

RS 76 C Full-travel key switch, illuminable, momentary

Technical data see page 4 - 158

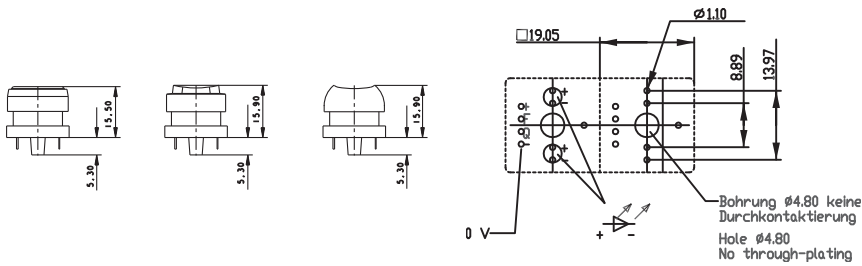

→ Contact function	Operating life min. (operations)	Illumination	Operating force max.	Operating travel	Order no.
momentary	10 ⁸	with LED	0.7 N	4 mm	3.13.001.110/0000

PCB KEY SWITCHES

RS 76 C - FULL-TRAVEL KEY SWITCHES, ILLUMINATED



RS 76 C Full-travel key switch, illuminable, latching

Technical data see page 4 - 158

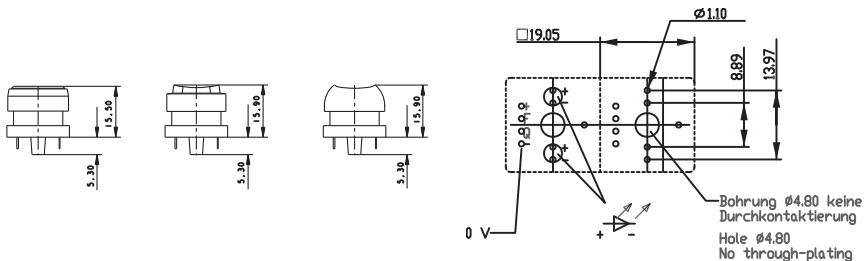

→ Contact function	Operating life min. (operations)	Illumination	Operating force max.	Operating travel	Order no.
latching	10 ⁵	with LED	0.7 N	4 mm	3.13.001.130/0000

RS 76 Keycaps, not illuminable



Technical Data

→ **General information**

Form of lens	see order block
Color of keycap / legending	see order block
Color of lens / legend insert	see order block
Illumination	see order block
Degree of protection	see order block
Size of keycap	see order block

→ **Other specifications**

ROHS compliant	yes
REACH compliant	yes

RS 76 C Keycap, opaque

Technical data see page 4 - 161



Keycap, light grey



→ Size of keycap	Illumination	Color of keycap / legending	Color of lens / legend insert	Order no.
1-module	no	charcoal grey/-	-	5.82.000.000/0152
1-module	no	light grey/-	-	5.82.000.000/0242

Keycap sets available in two-shot molded design.

Other keycap sizes, e.g. 1.25-, 1.5-, 1.75-, 2-, 3-, 5- and 8-module versions available on request.

PCB KEY SWITCHES

RS 76 - KEYCAPS, NON-ILLUMINATED



RS 76 C Keycap, opaque, with nail protection

Technical data see page 4 - 161



opaque with nail protection charcoal grey / white

→ Size of keycap	Illumination	Color of keycap / legending	Color of lens / legend insert	Order no.
1-module	no	charcoal grey/-	-	5.80.000.000/0152
1-module	no	light grey/-	-	5.80.000.000/0242

Keycap sets available in two-shot molded design.

Other keycap sizes, e.g. 1.25-, 1.5-, 1.75-, 2-, 3- and 8-module versions available on request.

4



RS 76 C Keycap with legend insert

Technical data see page 4 - 161

→ Size of keycap	Illumination	Color of keycap / legending	Color of lens / legend insert	Order no.
1-module	no	charcoal grey/-	colorless/white	5.04.665.221/5520
1-module	no	light grey/-	colorless/white	5.04.665.230/5520

Supplied as single parts: Mat lens, legend insert, keycap body.

Other colors on request.

RS
76

RS 76 Keycaps, illuminable

Technical Data

→ **General information**

Form of lens	see order block
Color of keycap / legending	see order block
Color of lens / legend insert	see order block
Illumination	see order block
Degree of protection	see order block
Size of keycap	see order block

→ **Other specifications**

ROHS compliant	yes
REACH compliant	yes



RS 76 Keycap with light bar

Technical data see page 4 - 163



→ Size of keycap	Illumination	Color of keycap / legending	Color of lens / legend insert	Order no.
1-module	yes	light grey/-	-	5.82.110.000/0242
1-module	yes	charcoal grey/-	-	5.82.110.000/0152

Other colors on request.

PCB KEY SWITCHES

RS 76 - KEYCAPS, ILLUMINATED



RS 76 Keycap, illuminable, with legend insert

Technical data see page 4 - 163

→ Size of keycap	Illumination	Color of keycap / legending	Color of lens / legend insert	Order no.
1-module	yes	charcoal grey/-	colorless/white	5.04.665.521/5520
1-module	yes	light grey/-	colorless/white	5.04.665.530/5520

Supplied as single parts: Mat lens, legend insert, diffuser foil, keycap body.

Other colors on request.



RS 76 Keycap, illuminable, with nail protection and legend insert

Technical data see page 4 - 163

→ Size of keycap	Illumination	Color of keycap / legending	Color of lens / legend insert	Order no.
1-module	yes	charcoal grey/-	colorless/white	5.04.665.911/5520
1-module	yes	light grey/-	colorless/white	5.04.665.920/5520

Supplied as single parts: Mat lens, legend insert, keycap body.

Other colors on request.

4

RS
76

RS 76 Keycap, illuminable, with legend insert

Technical data see page 4 - 163



→ Size of keycap	Illumination	Color of keycap / legending	Color of lens / legend insert	Order no.
1-module	yes	charcoal grey/-	colorless/white	5.04.665.161/5520
1-module	yes	light grey/-	colorless/white	5.04.665.170/5520

Supplied as single parts: Mat lens, legend insert, diffuser foil, keycap body.
Other colors on request.

RS 76 MX Keycap, fully illuminable

Technical data see page 4 - 163



RS 76MX, with illuminated keycaps

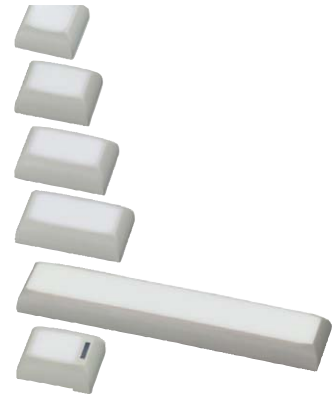

→ Size of keycap	Illumination	Color of keycap / legending	Color of lens / legend insert	Order no.
1-module	yes	white/-	white translucent/-	5.05.511.168/0209
1-module	yes	light grey/-	white translucent/-	5.05.511.168/0754
1¼-module	yes	white/-	white translucent/-	5.05.511.169/0209
1½-module	yes	white/-	white translucent/-	5.05.511.170/0209
1¾-module	yes	white/-	white translucent/-	5.05.511.171/0209
1¼-module with light conductor	yes	white/-	white translucent/-	5.05.511.173/0209

Laser-printed versions available on request.

PCB KEY SWITCHES

RS 76 - KEYCAPS, WITH LEGEND, TWO-SHOT MOLDED/KEYCAP SETS

RS 76 Keycaps, with legend, two-shot molded/ keycap sets



Mouse button, 2 x PS/2 connector

Technical Data

→ General information

Form of lens	see order block
Color of keycap / legending	see order block
Symbol	see order block
Illumination	see order block
Degree of protection	see order block
Size of keycap	see order block

→ Other specifications

ROHS compliant	yes
REACH compliant	yes

4

RS 76 Keycap set, symbols A-Z

Technical data see page 4 - 166



light beige

→ Size of keycap	Form of lens	Color of keycap / legending	Symbol	Order no.
1-module	keycap opaque with nail protection	charcoal grey/white	A-Z	5.00.999.500/0000
1-module	keycap opaque with nail protection	light grey/black	A-Z	5.00.999.824/0000
1-module	keycap opaque	charcoal grey/white	A-Z	5.00.999.525/0000
1-module	keycap opaque	light grey/black	A-Z	5.00.999.825/0000

Other symbols and colors on request.

RS
76

PCB KEY SWITCHES

RS 76 - KEYCAPS, WITH LEGEND, TWO-SHOT MOLDED/KEYCAP SETS

RS 76 Keycap set, symbols 0-9

Technical data see page 4 - 166

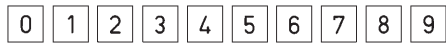

opaque with nail protection charcoal grey / white

→ Size of keycap	Form of lens	Color of keycap / legending	Symbol	Order no.
1-module	keycap opaque with nail protection	charcoal grey/white	0-9	5.00.999.504/0000
1-module	keycap opaque with nail protection	light grey/black	0-9	5.00.999.826/0000
1-module	keycap opaque	charcoal grey/white	0-9	5.00.999.529/0000
1-module	keycap opaque	light grey/black	0-9	5.00.999.827/0000

Other symbols and colors on request.

PCB KEY SWITCHES

RS 76 - SPECIAL ACCESSORIES

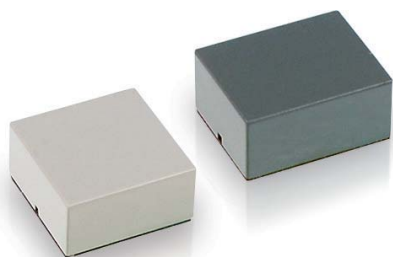

RS 76 Accessories

Technical Data

→ General information

Color	see order block
Size	see order block

→ Other specifications

ROHS compliant	yes
REACH compliant	yes

RS 76 Cover IP40

Technical data see page 4 - 168

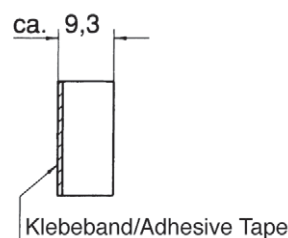
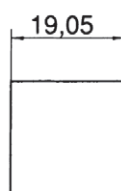

4

→ Color	Size	Order no.
charcoal grey	¼-module	5.04.520.171/0152
light grey	¼-module	5.04.520.171/0242
light beige	¼-module	5.04.520.171/0710
dark grey	¼-module	5.04.520.171/0801
charcoal grey	½-module	5.04.520.172/0152
light grey	½-module	5.04.520.172/0242
light beige	½-module	5.04.520.172/0710
dark grey	½-module	5.04.520.172/0801
charcoal grey	¾-module	5.04.520.173/0152
light grey	¾-module	5.04.520.173/0242
light beige	¾-module	5.04.520.173/0710
dark grey	¾-module	5.04.520.173/0801
charcoal grey	1-module	5.04.520.174/0152

RS
76

PCB KEY SWITCHES

RS 76 - SPECIAL ACCESSORIES

– Table (continued) –
RS 76 - Cover IP40

→ Color	Size	Order no.
light grey	1-module	5.04.520.174/0242
light beige	1-module	5.04.520.174/0710
dark grey	1-module	5.04.520.174/0801

Other colors on request.



Keylock / rotary switches

for PCB

Keylock switches for PCB mounting. Matching with the RS 76 full-travel key switches and the RF 15 and RF 19 tactile switches.

- All products are RoHS compliant.
-

PCB KEY SWITCHES

MICROMECC - KEYLOCK SWITCHES

Content

MICROMECC - Keylock switches, IP54	4 - 173
MICROMECC - Keylock switch IP54	4 - 176
EUROLOCKS - Keylock switches, IP54	4 - 177
EUROLOCKS - Keylock switch IP54	4 - 178
Priority keylock switches, IP54	4 - 179
Priority keylock switch IP54	4 - 180
Rotary switches, IP40	4 - 181
Rotary switch IP40	4 - 182

MICROMECC Keylock switches, IP54

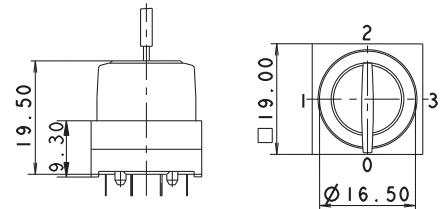

Technical Data

→ General information

Color	see order block
Form of collar	square

→ Dimensions

Length of collar	19 mm
Width of collar	19 mm
Overall height	19.5 mm

→ Mechanical design

Mounting	soldering
Terminals	tin-plated
Contact system	cross contact self cleaning
Contact function	see order block
Contact materials	Au alloy
Illuminability	no
Lock	Micromec
Wafers	5
Lock type	001
Number of locking positions	500
Main key	on request
Key removal position	see order block

→ Mechanical characteristics

Switching torque	0.04 ... 0.10 Nm
Robustness max.	2 Nm
Dielectric strength AC min.	500 V
Rated power max.	1 W

→ Electrical characteristics

Rated voltage	2 ... 35 V
Rated current max.	100 mA
Contact resistance when new max.	100 mΩ
Contact resistance acc. to life max.	200 mΩ
Insulation resistance	10 ⁹ Ω
ESD strength max.	8 kV

→ Other specifications

Rotating angle	see order block
Operating life	10,000
Degree of protection from front side	IP54
Ambient temp. operating min.	-25 °C
Ambient temp. operating max.	+70 °C
Storage temperature min.	-40 °C
Storage temperature max.	+80 °C
Environmental resistance	acc. to IEC 60068-2-14, -30, -33 and -78
Flammability of materials	UL 94 HB
ROHS compliant	yes
REACH compliant	yes





Accessories MICROMECC - Keylock switch IP54

→ Description	Photo	Order no.	Additional accessories see page
O-ring for keylock switch		5.30.120.015/0100	5 - 31

PCB KEY SWITCHES

MICROMECC - KEYLOCK SWITCHES IP 54

– Table (continued) –
Accessories MICROMECC - Keylock switch IP54

→ Description	Photo	Order no.	Additional accessories see page
Spare key, (delivery content 1 key)		5.58.007.001/0000	-
Spare key, for double action, e.g. 2 x 90° (delivery content 1 key)		5.58.008.001/0000	-
Spare key for 3 angles, f.ex. 3 x 90° degree (content 1 key)		5.58.009.001/0100	-
Spare key for 4 angles, f.ex. 4 x 90 degrees, (content 1 key)		5.58.010.001/0100	-

PCB KEY SWITCHES

MICROMECC - KEYLOCK SWITCHES IP 54

Dimensional drawing

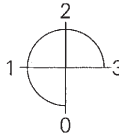
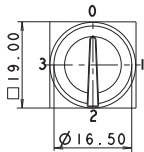
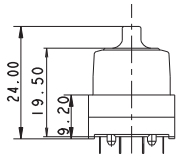

Circuit diagram

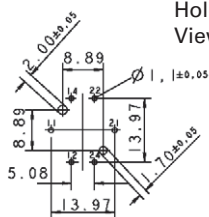

Hole patterns PCB
View on component side

Switching position	Contact function
0	
1	
2	
3	

PCB KEY SWITCHES

MICROMECC - KEYLOCK SWITCHES IP 54



MICROMECC Keylock switch IP54

Technical data see page 4 - 173

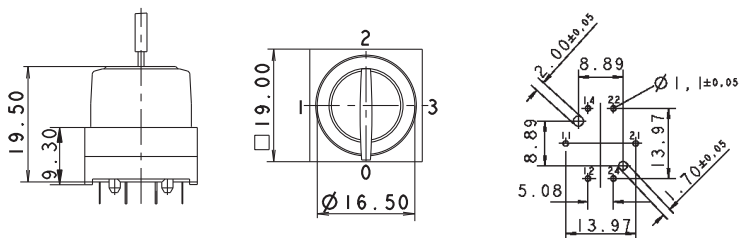

PCB hole pattern, component side

→ Contact function	Color	Rotating angle	Key removal position	Order no.
momentary	charcoal grey	1 x 40°	0	3.13.026.041/0000
momentary	light grey	1 x 40°	0	3.13.026.541/0000
latching	charcoal grey	1 x 90°	0	3.13.026.001/0000
latching	light grey	1 x 90°	0	3.13.026.501/0000
latching	charcoal grey	1 x 90°	0+1	3.13.026.006/0000
latching	light grey	1 x 90°	0+1	3.13.026.506/0000
latching	charcoal grey	3 x 90°	0	3.13.026.021/0000
latching	light grey	3 x 90°	0	3.13.026.521/0000
latching	charcoal grey	3 x 90°	0+1+2+3	3.13.026.026/0000
latching	light grey	3 x 90°	0+1+2+3	3.13.026.526/0000
latching	charcoal grey	4 x 90° without stop	0	3.13.026.031/0000
latching	light grey	4 x 90° without stop	0	3.13.026.531/0000
latching	charcoal grey	4 x 90° without stop	0+1+2+3	3.13.026.036/0000
latching	light grey	4 x 90° without stop	0+1+2+3	3.13.026.536/0000
latching	charcoal grey	2 x 90°	0	3.13.026.011/0000
latching	light grey	2 x 90°	0	3.13.026.511/0000
latching	charcoal grey	2 x 90°	0+1+2	3.13.026.016/0000
latching	light grey	2 x 90°	0+1+2	3.13.026.516/0000
latching	charcoal grey	2 x 90°	0	3.13.026.601/0000
latching	light grey	2 x 90°	0	3.13.026.851/0000
latching	charcoal grey	2 x 90°	0+1+3	3.13.026.606/0000
latching	light grey	2 x 90°	0+1+3	3.13.026.856/0000

2 keys included.

Other lock variants available on request.

EUROLOCKS Keylock switches, IP54

Technical Data

→ General information

Color	see order block
Form of collar	square

→ Dimensions

Length of collar	19 mm
Width of collar	19 mm
Overall height	19.5 mm

→ Mechanical design

Mounting	soldering
Terminals	tin-plated
Contact system	cross contact self cleaning
Contact function	latching
Contact materials	Au alloy
Illuminability	no
Lock	Eurolocks
Wafers	5
Lock type	801
Number of locking positions	50
Main key	no
Symmetric key	yes
Key removal position	see order block

→ Mechanical characteristics

Switching torque	0.04 ... 0.10 Nm
Robustness max.	2 Nm
Dielectric strength AC min.	500 V
Rated power max.	1 W

→ Electrical characteristics

Rated voltage	2 ... 35 V
Rated current max.	100 mA
Contact resistance when new max.	100 mΩ
Contact resistance acc. to life max.	200 mΩ
Insulation resistance	10 ⁹ Ω
ESD strength max.	8 kV

→ Other specifications

Rotating angle	see order block
Operating life	10,000
Degree of protection from front side	IP54
Ambient temp. operating min.	-25 °C
Ambient temp. operating max.	+70 °C
Storage temperature min.	-40 °C
Storage temperature max.	+80 °C
Environmental resistance	acc. to IEC 60068-2-14, -30, -33 and -78
Flammability of materials	UL 94 HB
ROHS compliant	yes
REACH compliant	yes

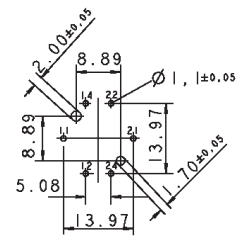
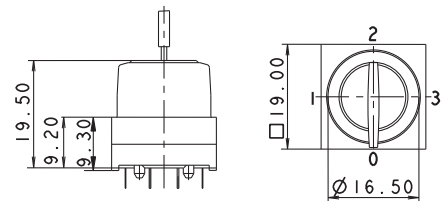

PCB hole pattern, component side

Accessories EUROLOCKS - Keylock switch IP54

→ Description	Photo	Order no.	Additional accessories see page
O-ring for keylock switch		5.30.120.015/0100	5 - 31

PCB KEY SWITCHES

EUROLOCKS - KEYLOCK SWITCHES IP 54

**– Table (continued) –
Accessories EUROLOCKS - Keylock switch IP54**

→ Description	Photo	Order no.	Additional accessories see page
Spare key (delivery content 1 key)		5.58.006.801/0000	-



EUROLOCKS Keylock switch IP54

Technical data see page 4 - 177

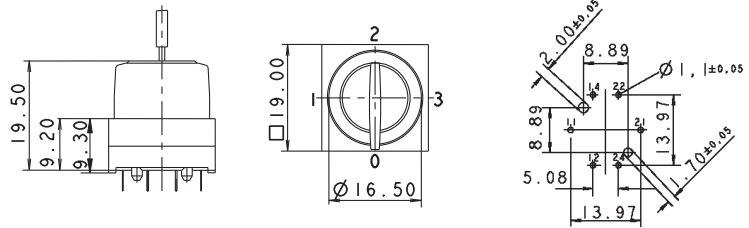

PCB hole pattern, component side

→ Contact function	Color	Rotating angle	Key removal position	Order no.
latching	charcoal grey	1 x 90°	0	3.13.009.001/0000
latching	light grey	1 x 90°	0	3.13.009.006/0000
latching	charcoal grey	1 x 90°	0+1	3.13.009.031/0000
latching	light grey	1 x 90°	0+1	3.13.009.036/0000

4

2 keys included.

Other lock variants available on request.

For the switching arrangement, refer to Micromec keylock switch IP54.

PRIORITY KEYLOCK SWITCHES, IP54

→ Either 2 or 3 different keys are required, depending on the angle between positions. Key 1 can switch to position 1, key 2 can switch to position 1 and 2, etc.



Technical Data

→ General information

Color	see order block
Form of collar	square

→ Dimensions

Length of collar	19 mm
Width of collar	19 mm
Overall height	19.5 mm

→ Mechanical design

Mounting	soldering
Terminals	tin-plated
Contact system	cross contact self cleaning
Contact function	see order block
Contact materials	Au alloy
Illuminability	no
Lock	Micromec
Wafers	5
Lock type	001
Number of locking positions	500
Main key	on request
Key removal position	see order block

→ Mechanical characteristics

Switching torque	0.04 ... 0.10 Nm
Robustness max.	2 Nm
Dielectric strength AC min.	500 V
Rated power max.	1 W

→ Electrical characteristics

Rated voltage	2 ... 35 V
Rated current max.	100 mA
Contact resistance when new max.	100 mΩ
Contact resistance acc. to life max.	200 mΩ
Insulation resistance	10 ⁹ Ω
ESD strength max.	8 kV

→ Other specifications

Rotating angle	see order block
Operating life	10,000
Degree of protection from front side	IP54
Ambient temp. operating min.	-25 °C
Ambient temp. operating max.	+70 °C
Storage temperature min.	-40 °C
Storage temperature max.	+80 °C
Environmental resistance	acc. to IEC 60068-2-14, -30, -33 and -78
Flammability of materials	UL 94 HB
ROHS compliant	yes
REACH compliant	yes

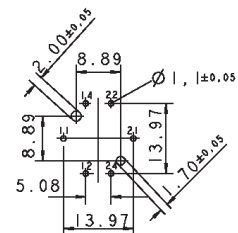
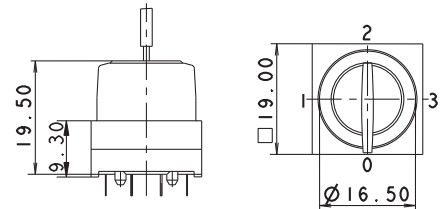



PCB hole pattern, component side

PCB KEY SWITCHES

PRIORITY KEYLOCK SWITCHES IP 54

Accessories Priority keylock switch IP54

→ Description	Photo	Order no.	Additional accessories see page
O-ring for keylock switch		5.30.120.015/0100	5 - 31
Set of keys for 2 x 90° type (2 keys)		5.58.099.012/0000	-
Set of keys for 3 x 90° type (3 keys)		5.58.099.013/0000	-



Priority keylock switch IP54

Technical data see page 4 - 179

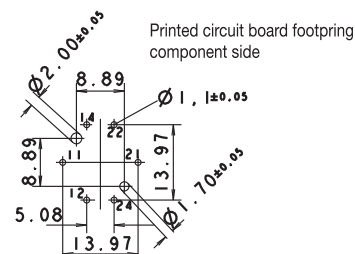
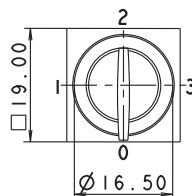
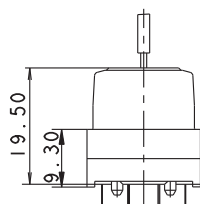

PCB hole pattern, component side

→ Contact function	Color	Rotating angle	Key removal position	Order no.
latching	charcoal grey	3 x 90°	0	3.13.027.011/0000
latching	light grey	3 x 90°	0	3.13.027.511/0000
latching	charcoal grey	3 x 90°	0+1+2+3	3.13.027.016/0000
latching	light grey	3 x 90°	0+1+2+3	3.13.027.516/0000
latching	charcoal grey	2 x 90°	0	3.13.027.001/0000
latching	light grey	2 x 90°	0	3.13.027.501/0000
latching	charcoal grey	2 x 90°	0+1+2	3.13.027.006/0000
latching	light grey	2 x 90°	0+1+2	3.13.027.506/0000

2 sets of keys included.

Other lock variants available on request.

For the switching arrangement, see IP54 Micromec keylock switch.

Either 2 or 3 different keys are required, depending on the angle between positions. Key 1 can switch to position 1, key 2 can switch to position 1 and 2, etc.

ROTARY SWITCHES, IP40

Technical Data

→ General information

Color	see order block
Form of collar	square

→ Dimensions

Length of collar	19 mm
Width of collar	19 mm
Overall height	24 mm

→ Mechanical design

Mounting	soldering
Terminals	tin-plated
Contact system	cross contact self cleaning
Contact function	see order block
Contact materials	Au alloy
Illuminability	no

→ Mechanical characteristics

Torque against stop min.	0.45 Nm
Dielectric strength AC min.	see order block
Rated power max.	1 W

→ Electrical characteristics

Rated voltage max.	35 V
Rated current max.	100 mA
Contact resistance when new max.	100 mΩ
Contact resistance acc. to life max.	200 mΩ
Insulation resistance	10 ⁹ Ω
ESD strength max.	8 kV

→ Other specifications

Rotating angle	see order block
Operating life	50,000
Degree of protection from front side	IP40 (DIN EN 60529)
Ambient temp. operating min.	-25 °C
Ambient temp. operating max.	+70 °C
Storage temperature min.	-40 °C
Storage temperature max.	+80 °C
Environmental resistance	acc. to IEC 60068-2-14, -30, -33 and -78
Flammability of materials	UL 94 HB
ROHS compliant	yes
REACH compliant	yes

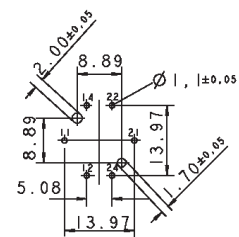
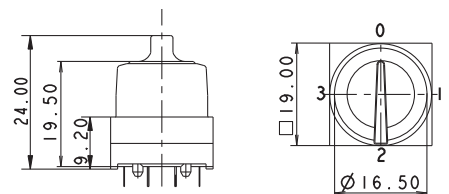

PCB hole pattern, component side

PCB KEY SWITCHES

ROTARY SWITCHES IP40



Rotary switch IP40

Technical data see page 4 - 181

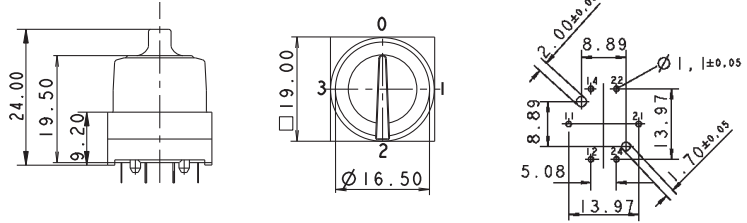

PCB hole pattern, component side

→ Contact function	Color	Rotating angle	Order no.
latching	charcoal grey	1 x 90°	3.13.007.001/0152
latching	charcoal grey	3 x 90°	3.13.007.021/0152
latching	charcoal grey	4 x 90°	3.13.007.031/0152
latching	charcoal grey	2 x 90°	3.13.007.011/0152

Other color variants available on request