

## Features/Benefits

- Compact design
- Short stroke to latch
- Wide variety of actuator heights
- Adapted for medium power applications
- RoHS compliant and compatible

## Typical Applications

- Automotive (air conditioning, lighting)
- Industrial
- Control panel

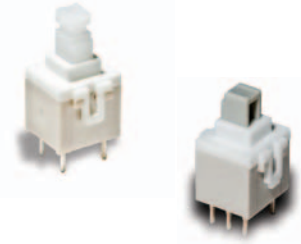

## Construction

FUNCTION: Momentary, Push-Push  
 CONTACT ARRANGEMENT:  
 PVA1: 2 make contacts (DPST)  
 PVA2: 2 change over contacts (DPDT)  
 SWITCHING MODE: Non-shorting  
 TERMINALS: PC pins<sup>1</sup>

## Mechanical

TOTAL TRAVEL / LATCHING TRAVEL:  
 OA: 2,4 mm  
 EE: 2,4 / 1,5 mm  
 ELECTRICAL TRAVEL: 0.8 mm (1.1 for PVA2 OA H5)  
 OPERATING FORCE: 1,2N; 1,7N; 3,5N

## Process

SOLDERABILITY:  
 Wave soldering, compatible with lead free soldering profile  
 Hand soldering, 350°C for 3 seconds

## Electrical

SWITCHING POWER MAX.: 3 W DC  
 SWITCHING VOLTAGE MAX.: 32 V DC  
 SWITCHING CURRENT MAX.: 100 mA DC\*  
 DIELECTRIC STRENGTH (50 Hz / 1 min):  
 1000 V between open contacts, PVA2: 750 V  
 OPERATING LIFE:  
 OA (momentary):  $\geq 1 \times 10^5$  operations  
 EE (push-push):  $\geq 1 \times 10^5$  operations  
 CONTACT RESISTANCE: Initial  $\leq 100 \text{ m}\Omega$   
 INSULATION RESISTANCE:  $\geq 10^{10} \Omega$   
 BOUNCE TIME:  $\leq 3 \text{ ms}$

## Environmental

OPERATING TEMPERATURE: -40°C to 85°C.<sup>2</sup>

- 1) "Snap-in" contacts on request, Version SNA with pins bent inside (standard)  
 2) With button +70°C

**Note:** Specifications listed above are for switches with standard options.

For information on specific and custom switches, please contact technical support using the "Ask a Specialist" option on the PVA product web page.<sup>v</sup>

## How To Order

Our easy build-a-switch concept allows you to mix and match options to create the switch you need. To order, select desired option from each category and place it in the appropriate box. **Some of the configurations may not be available or could require some development.**

### Switch

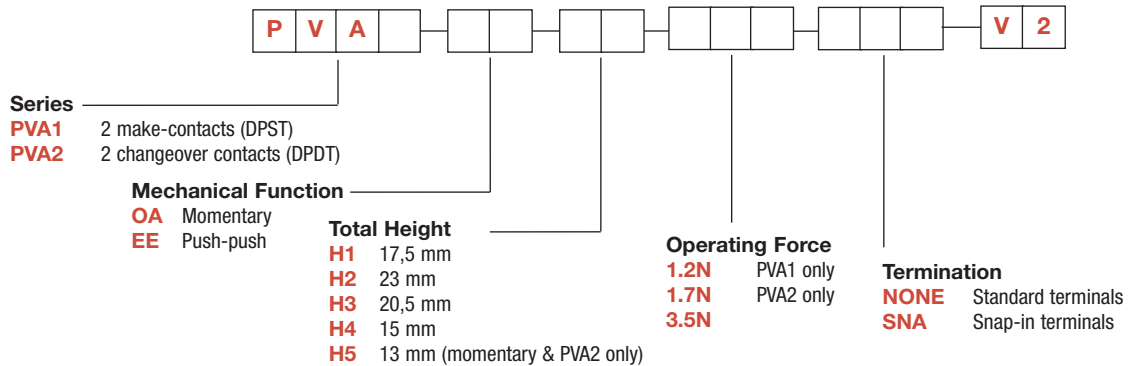

### Button

Buttons must be ordered separately.  
 Shipped in bulk.

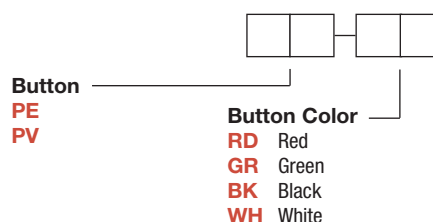

# PVA Short Stroke Key Switches

SERIES 

## PVA1 (DPST)

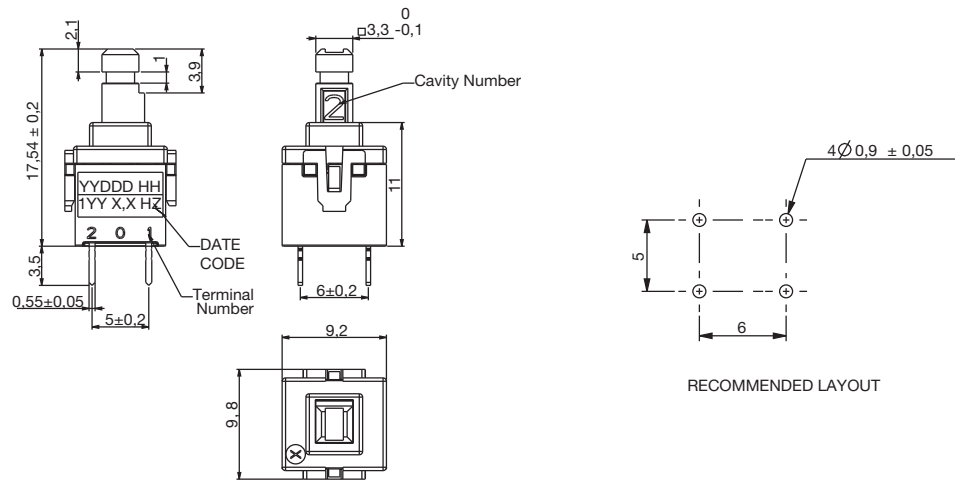

## PVA2 (DPDT)

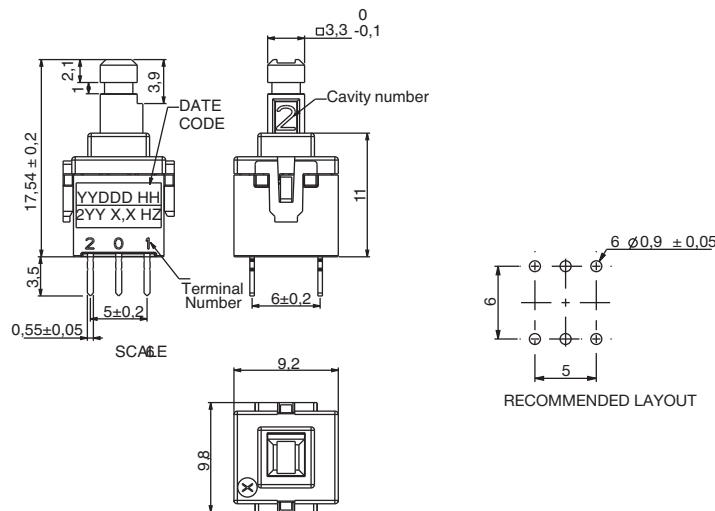

## MECHANICAL FUNCTION

OPTION CODE	FUNCTION
<b>OA</b>	Momentary
<b>EE</b>	Push-Push

**OA**

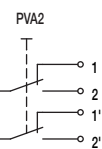
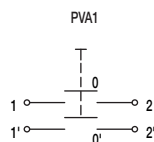

**EE**

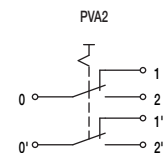
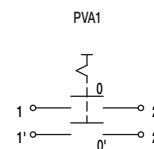

Dimensions are shown: mm  
Specifications and dimensions subject to change

# PVA Short Stroke Key Switches

## TOTAL HEIGHT

**H1** 17,5 MM

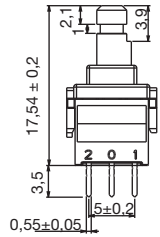

**H2** 23 MM

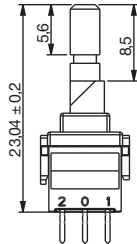

**H3** 20,5 MM

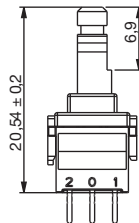

**H4** 15 MM

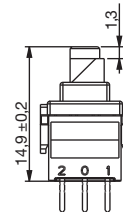

**H5** 13 MM  
(MOMENTARY ONLY)

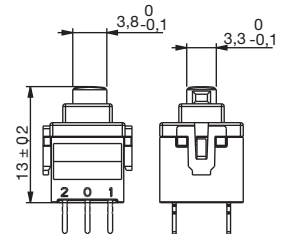

## OPERATING FORCE

**1.2N** PVA1 ONLY  
**1.7N** PVA2 ONLY  
**3.5N**

## TERMINATION

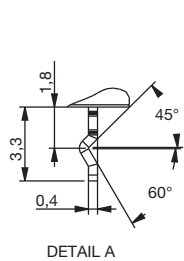

DETAIL A

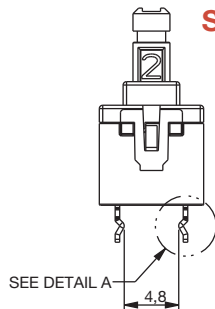

**SNA with PVA1**

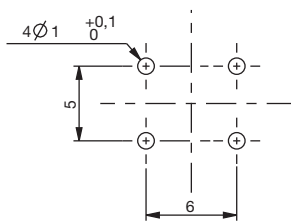

**SNA with PVA2**

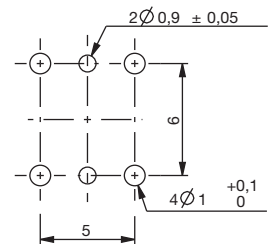
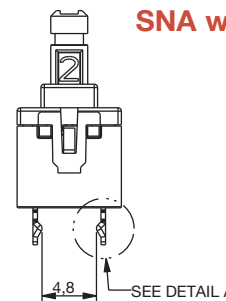

## BUTTONS

BUTTONS MUST BE ORDERED SEPARATELY. SHIPPED IN BULK.

**PE**

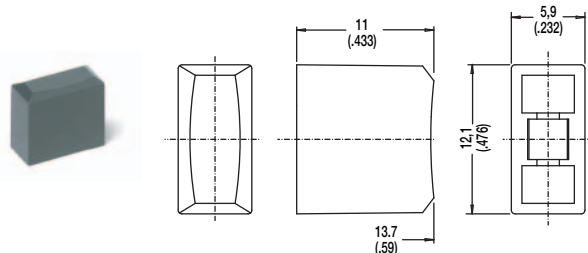

**PV**

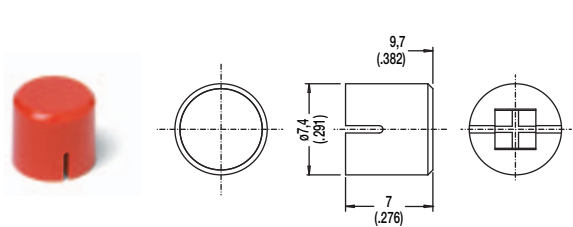

OPTION CODE	COLOR
<b>RD</b>	Red
<b>GY</b>	Gray
<b>BK</b>	Black
<b>WH</b>	White



First Angle Projection