

# KH206

## Overdrive-Protected Wideband Op Amp

### Features

- -3dB bandwidth of 180MHz
- 70MHz large signal bandwidth (20V<sub>pp</sub>)
- 0.1% settling in 19ns
- Overdrive protected
- Output may be current limited
- Stable without compensation
- 3MΩ input impedance
- Direct replacement for CLC206

### Applications

- Fast, precision A/D conversion
- Automatic test equipment
- Input/output amplifiers
- Photodiode, CCD preamps
- High-speed modems, radios
- Line drivers

### General Description

The KH206 is a wideband, overdrive-protected operational amplifier designed for applications needing both speed and high drive capability (100mA). Utilizing a well-established current feedback architecture, the KH206 exhibits performance far beyond that of conventional voltage feedback op amps. For example, the KH206 has a bandwidth of 180MHz at a gain of +20 and settles to 0.1% in 19ns. Plus, the KH206 has a combination of important features not found in other high-speed op amps.

The 100mA output current and the large signal bandwidth of 70MHz (20V<sub>pp</sub>) make the KH206 ideal for applications which involve both high signal amplitudes and heavy loads as in coaxial line driving applications.

Complete overdrive protection has been designed into the KH206. This is critical for applications, such as ATE and instrumentation, which require protection from signal levels high enough to cause saturation of the amplifier. This feature allows the output of the op amp to be protected against short circuits using techniques developed for low-speed op amps. With this capability, even the fastest signal sources can feature effective short circuit protection.

The KH206 is constructed using thin film resistor/bipolar transistor technology, and is available in the following versions:

KH206AI	-25°C to +85°C	12-pin TO-8 can
KH206AK	-55°C to +125°C	12-pin TO-8 can, features burn-in & hermetic testing
KH206AM	-55°C to +125°C	12-pin TO-8 can, environmentally screened and electrically tested to MIL-STD-883
KH206HXC	-55°C to +125°C	SMD#: 5962-8985801HXC
KH206HXA	-55°C to +125°C	SMD#: 5962-8985801HXA

Small Signal Pulse Response

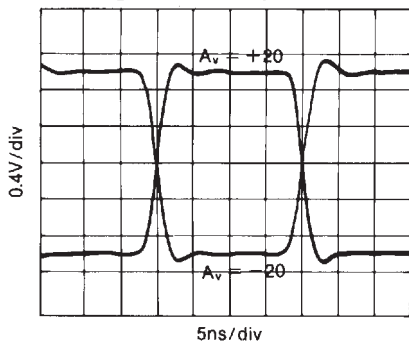

Bottom View

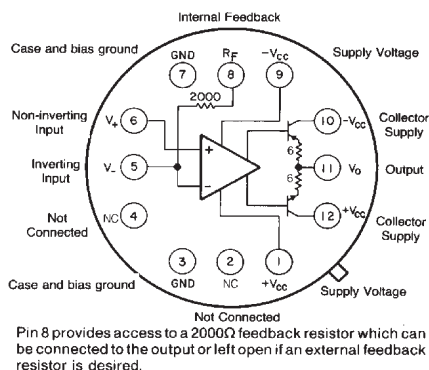

### Typical Performance

parameter	gain setting						units
	+7	+20	+50	-1	-20	-50	
-3dB bandwidth	220	180	90	220	145	90	MHz
rise time	1.6	2	4	1.6	2.5	4	ns
slew rate	3.4	3.4	3.4	3.4	3.4	3.4	V/ns
settling time (to 0.1%)	22	19	17	20	19	18	ns

## KH206 Electrical Characteristics ( $A_v = +20, V_{cc} = \pm 15V, R_L = 200\Omega, R_f = 2k\Omega$ ; unless specified)

PARAMETERS	CONDITIONS	TYP	MAX & MIN RATINGS				UNITS	SYMBOL
Ambient Temperature	KH206AI	+25°C	-25°C	+25°C	+85°C			
Ambient Temperature	KH206AK/AM/HXC/HXA	+25°C	-55°C	+25°C	+125°C			
<b>FREQUENCY DOMAIN RESPONSE</b>								
+3dB bandwidth	$V_{out} < 2V_{pp}$	180	>150	>150	>135	MHz	SSBW	
large signal bandwidth	$V_{out} < 20V_{pp}$	70	>54	>60	>60	MHz	FPBW	
gain flatness	$V_{out} < 2V_{pp}$							
+ peaking	0.1 to 40MHz	0	<0.3	<0.3	<0.5	dB	GFPL	
+ peaking	>40MHz	0	<0.5	<0.5	<0.8	dB	GFPH	
+ rolloff	at 75MHz	—	<0.7	<0.7	<0.7	dB	GFR	
group delay	to 75MHz	3.0±.2	—	—	—	ns	GD	
linear phase deviation	to 75MHz	0.6	<2.0	<1.5	<2.0	°	LPD	
<b>TIME DOMAIN RESPONSE</b>								
rise and fall time	2V step	2.0	<2.5	<2.5	<2.7	ns	TRS	
	20V step	7.0	<8.5	<8.5	<8.5	ns	TRL	
settling time to 0.1%	10V step, note 2	22	<25	<25	<25	ns	TS	
to 0.05%	10V step, note 2	24	<27	<27	<27	ns	TSP	
overshoot	10V step	11	<15	<15	<15	%	OS	
slew rate	20V <sub>pp</sub> , 100MHz	3.4	>2.7	>3.0	>3.0	V/ns	SR	
<b>DISTORTION AND NOISE RESPONSE</b>								
+2nd harmonic distortion	2V <sub>pp</sub> , 20MHz	-59	<-50	<-50	<-50	dBc	HD2	
+3rd harmonic distortion	2V <sub>pp</sub> , 20MHz	-67	<-55	<-55	<-55	dBc	HD3	
equivalent input noise								
voltage	>100kHz	2.1	<3.0	<3.0	<3.5	nV/ $\sqrt{\text{Hz}}$	VN	
inverting current	>100kHz	22	<30	<30	<35	pA/ $\sqrt{\text{Hz}}$	ICN	
non-inverting current	>100kHz	5.0	<7.0	<7.0	<8.0	pA/ $\sqrt{\text{Hz}}$	NCN	
noise floor	>100kHz	-157	<-154	<-154	<-153	dBm(1Hz)	SNF	
integrated noise	1kHz to 150MHz	39	<55	<55	<61	uV	INV	
noise floor	>5MHz	-157	<-154	<-154	<-153	dBm(1Hz)	SNF	
integrated noise	5MHz to 150MHz	39	<55	<55	<61	uV	INV	
<b>STATIC, DC PERFORMANCE</b>								
*input offset voltage		3.5	<8.0	<8.0	<11.0	mV	VIO	
average temperature coefficient		11	<25	<25	<25	uV/°C	DVIO	
*input bias current	non-inverting	4.0	<30	<20	<20	uA	IBN	
average temperature coefficient		20	<125	<125	<125	nA/°C	DIBN	
*input bias current	inverting	2.0	<26	<10	<30	uA	IBI	
average temperature coefficient		40	<200	<200	<200	nA/°C	DIBI	
*power supply rejection ratio		65	>55	>55	>55	dB	PSRR	
common mode rejection ratio		60	>50	>50	>50	dB	CMRR	
*supply current	no load	29	<31	<31	<33	mA	ICC	
<b>MISCELLANEOUS PERFORMANCE</b>								
non-inverting input resistance	DC	3.0	>1.0	>1.0	>1.0	MΩ	RIN	
non-inverting input capacitance	75MHz	5.2	<7.0	<7.0	<7.0	pF	CIN	
output impedance	DC	—	<0.1	<0.1	<0.1	Ω	RO	
output voltage range	no load	±12	>±11	>±11	>±11	V	VO	
internal feedback resistor								
absolute tolerance		—	—	<0.2	—	%	RFA	
temperature coefficient		—	—	-100±40	—	ppm/°C	RFTC	
inverting input current self limit		3.3	<4.5	<4.5	<4.7	mA	ICL	

Min/max ratings are based on product characterization and simulation. Individual parameters are tested as noted. Outgoing quality levels are determined from tested parameters.

### Absolute Maximum Ratings

$V_{cc}$	±20V
$I_{out}$	±150mA
common mode input voltage	±(  $V_{cc}$   - 1)V
differential input voltage	±3V
thermal resistance: See thermal model.	
junction temperature	+175°C
operating temperature	AI: -25°C to +85°C
	AK/AM/HXC/HXA: -55°C to +125°C
storage temperature	-65°C to +150°C
lead temperature (soldering 10s)	+300°C

### Recommended Operating Conditions

$V_{cc}$	±5V to ±15V
$I_{out}$	±100mA
common mode input voltage	±(  $V_{cc}$   - 5)V
gain range:	+7 to +50, -1 to -50
<b>note 1:</b>	* AI/AK/AM/HXC/HXA 100% tested at 25°C.
	+ AK/AM/HXC/HXA 100% tested at +25°C & sample tested at -55°C & +125°C.
	+ AI sample tested at +25°C.
<b>note 2:</b>	Settling time specifications require the use of an external feedback resistor (2Ω).

# KH206 Typical Performance Characteristics ( $T_A = +25^\circ\text{C}$ , $A_v = +20$ , $V_{CC} = \pm 15\text{V}$ , $R_L = 200\Omega$ ; unless specified)

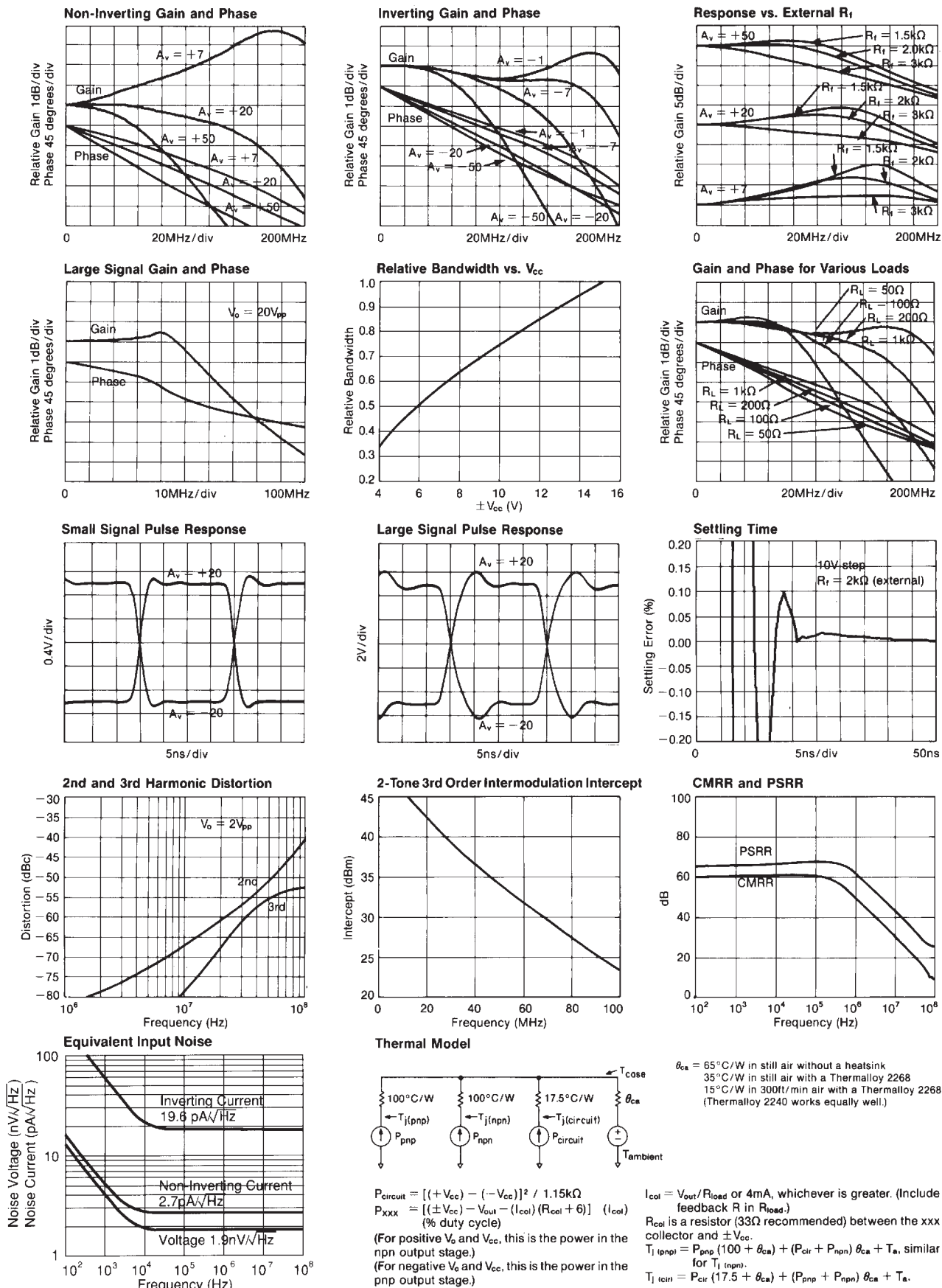

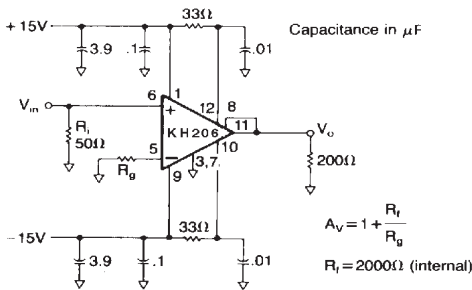

Figure 1: recommended non-inverting gain circuit

**Overdrive Protection**

Unlike most other high-speed op amps, the KH206 is not damaged by saturation caused by overdriving input signals (where  $V_{in} \times \text{gain} > V_{out}$ ). The KH206 self limits the current at the inverting input when the output is saturated (see the inverting input current self limit specification); this ensures that the amplifier will not be damaged due to excessive internal currents during overdrive. For protection against input signals which would exceed either the maximum differential or common mode input voltage, the diode clamp circuits below may be used.

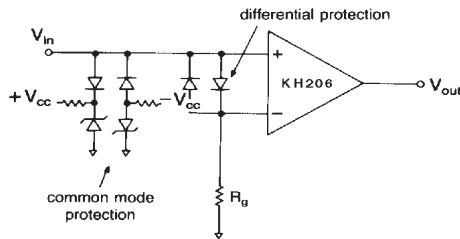

Figure 3: Diode clamp circuits for common mode and differential mode protection

**Short Circuit Protection:**

Damage caused by short circuits at the output may be prevented by limiting the output current to safe levels. The most simple current limit circuit calls for placing resistors between the output stage collector calls for placing resistors between the output stage collectors (pins 12 and 10). The value of this resistor is determined by:

$$R_c = \frac{V_c}{I_l} - R_l$$

Where  $I_l$  is the desired limit current and  $R_l$  is the minimum expected load resistance ( $0\Omega$  for a short to ground). Bypass capacitors of  $0.01\mu F$  on should be used on the collectors as in Figures 1 and 2.

A more sophisticated current limit circuit which provides a limit current independent of  $R_l$  is shown below.

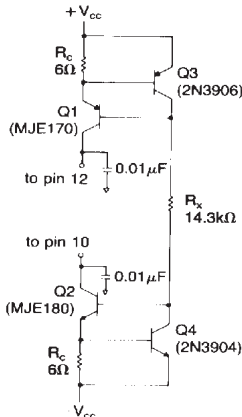

Figure 4: Active current limit circuit (100mA)

With the component values indicated, current limiting occurs at 100mA. For other values of current limit ( $I_l$ ), select  $R_c$  to equal  $V_{be}/I_l$ . Where  $V_{be}$  is the base to emitter voltage drop of Q3 (or Q4) at a current of  $[2V_{cc} - 1.4]/R_x$ , where

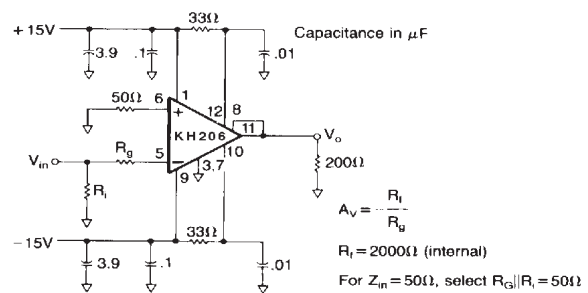

Figure 2: recommended inverting gain circuit

$R_x \leq [(2V_{cc} - 1.4)/I_l] B_{min}$ . Also,  $B_{min}$  is the minimum beta of Q1 (or Q2) at a current of  $I_l$ . Since the limit current depends on  $V_{be}$ , which is temperature dependent, the limit current is likewise temperature dependent.

**Controlling Bandwidth and Passband Response**

In most applications, a feedback resistor value of  $2k\Omega$  will provide optimum performance; nonetheless, some applications may require a resistor of some other value. The response versus  $R_f$  plot on the previous page shows how decreasing  $R_f$  will increase bandwidth (and frequency response peaking, which may lead to instability). Conversely, large values of feedback resistance tend to roll off the response.

The best settling time performance requires the use of an external feedback resistor (use of the internal resistor results in a 0.1% to 0.2% settling tail). The settling performance may be improved slightly by adding a capacitance of  $0.4pF$  in parallel with the feedback resistor (settling time specifications reflect performance with an external feedback resistor but with no external capacitance).

**Noise Analysis**

Approximate noise figure can be determined for the KH206 using the equivalent input noise graph on the preceding page and the equations shown below.

Noise figure is for the network inside this box

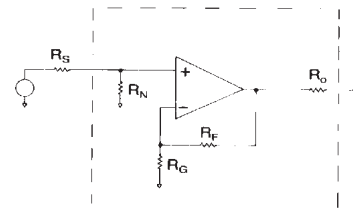

$$F = 10 \log \left[ 1 + \frac{R_s}{R_N} + \frac{R_s}{4kT} \cdot \left( i_n^2 + \frac{V_n^2}{R_p^2} + \frac{R_F^2 i_i^2}{R_p^2 A_v^2} \right) \right]$$

where  $R_p = \frac{R_s R_N}{R_s + R_N}$ ;  $A_v = \frac{R_F}{R_G} + 1$

- $kT = 4.00 \times 10^{-21}$  Joules at  $290^\circ K$
- $V_n$  is spot noise voltage ( $V/\sqrt{Hz}$ )
- $i_n$  is non-inverting spot noise current ( $A/\sqrt{Hz}$ )
- $i_i$  is inverting spot noise current ( $A/\sqrt{Hz}$ )

**Printed Circuit Layout**

As with any high frequency device, a good PCB layout will enhance the performance of the KH206. Good ground plane construction and power supply bypassing close to the package are critical to achieving full performance. In the non-inverting configuration, the amplifier is sensitive to stray capacitance to ground at the inverting input. Hence, the inverting node connections should be small with minimal stray capacitance to the ground plane. Shunt capacitance across the feedback resistor should not be used to compensate for this effect.

Evaluation PC boards (part number 730008 for inverting, 730009 for non-inverting) for the KH206 are available.

## KH206 Package Dimensions

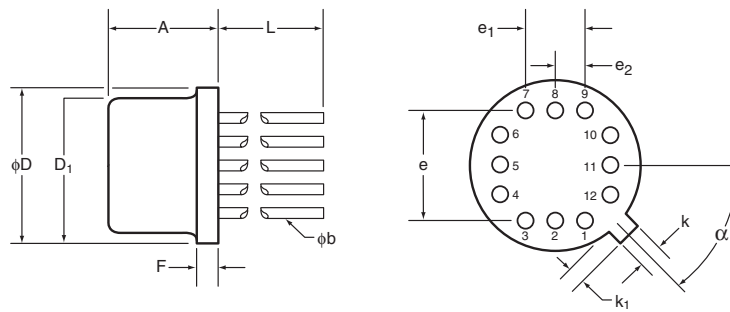

TO-8				
SYMBOL	INCHES		MILIMETERS	
	Minimum	Maximum	Minimum	Maximum
A	0.142	0.181	3.61	4.60
$\phi b$	0.016	0.019	0.41	0.48
$\phi D$	0.595	0.605	15.11	15.37
$\phi D_1$	0.543	0.555	13.79	14.10
e	0.400 BSC		10.16 BSC	
e <sub>1</sub>	0.200 BSC		5.08 BSC	
e <sub>2</sub>	0.100 BSC		2.54 BSC	
F	0.016	0.030	0.41	0.76
k	0.026	0.036	0.66	0.91
k <sub>1</sub>	0.026	0.036	0.66	0.91
L	0.310	0.340	7.87	8.64
$\alpha$	45° BSC		45° BSC	

## NOTES:

Seal: cap weld  
 Lead finish: gold per MIL-M-38510  
 Package composition:  
 Package: metal  
 Lid: Type A per MIL-M-38510

## Life Support Policy

Cadeca's products are not authorized for use as critical components in life support devices or systems without the express written approval of the president of Cadeca Microcircuits, Inc. As used herein:

1. Life support devices or systems are devices or systems which, a) are intended for surgical implant into the body, or b) support or sustain life, and whose failure to perform, when properly used in accordance with instructions for use provided in the labeling, can be reasonably expected to result in a significant injury to the user.
2. A critical component is any component of a life support device or system whose failure to perform can be reasonably expected to cause the failure of the life support device or system, or to affect its safety or effectiveness.

Cadeca does not assume any responsibility for use of any circuitry described, and Cadeca reserves the right at any time without notice to change said circuitry and specifications.