

Free Star Pro Series

**ZFSM-201-KIT-1
Development Kit
User's Guide**



ZFSM-201-1 FreeStar Pro Module

Document # 0006-00-08-00-000

(Rev B)

Table of Contents

1	INTRODUCTION	4
1.1	KIT DESCRIPTION.....	4
1.2	ZFSM-201-KIT-1 CONTENTS.....	5
1.2.1	<i>Optional Hardware and Software</i>	<i>5</i>
1.3	REFERENCED DOCUMENTS	6
2	HARDWARE OVERVIEW	6
2.1	ZFSM-201-EVB-1 OVERVIEW	6
2.2	DESCRIPTION OF THE MAJOR COMPONENTS – ZFSM-201-EVB-1.....	7
2.2.1	<i>Input Power:</i>	<i>7</i>
2.2.2	<i>Power Switch [SW6]:.....</i>	<i>7</i>
2.2.3	<i>Power LED [D5].....</i>	<i>7</i>
2.2.4	<i>Current Measurement Jumper [J9 2-pin].....</i>	<i>7</i>
2.2.5	<i>JTAG Port [J1 20-pin]:</i>	<i>8</i>
2.2.6	<i>Variable Resistors [VR1 & VR2]:.....</i>	<i>8</i>
2.2.7	<i>FLASH Erase Jumpers [J19 2-pin, J20 2-pin]:</i>	<i>8</i>
2.2.8	<i>Reset Switch [SW5]:.....</i>	<i>8</i>
2.2.9	<i>GPIO Header Connector [J2 26-pin]</i>	<i>8</i>
2.2.10	<i>Application Switches [SW1-SW4].....</i>	<i>8</i>
2.2.11	<i>LED's [D1-D4]</i>	<i>8</i>
2.2.12	<i>Timer I/O Connector [J3 4-pin].....</i>	<i>9</i>
2.2.13	<i>Supply Voltage Connector [J4 4-pin].....</i>	<i>9</i>
2.2.14	<i>ADC Input Channel Connector [J5 8-pin].....</i>	<i>9</i>
2.2.15	<i>Add on Antenna.....</i>	<i>9</i>
2.2.16	<i>GPIO Jumpers [J13 40-pin, J14 40-pin, J15 40-pin]:</i>	<i>9</i>
3	ZFSM-201-EVB-1 STANDALONE DEMONSTRATIONS.....	12
3.1	TRANSMISSION/RANGE DEMONSTRATION	12
3.1.1	<i>The Transmitter Setup.....</i>	<i>12</i>
3.1.2	<i>The Receiver Setup.....</i>	<i>12</i>
3.1.3	<i>Transmission Indicators.....</i>	<i>12</i>
3.1.4	<i>Testing the Range</i>	<i>12</i>
3.2	ADC DEMONSTRATION	12
4	FREESTAR PRO TEST TOOL SOFTWARE.....	13
4.1	SOFTWARE INSTALLATION AND SETUP	13
4.1.1	<i>Prerequisites to Installation</i>	<i>13</i>
4.1.2	<i>Installation</i>	<i>13</i>
4.2	GUI SCREEN DESCRIPTIONS	14
4.2.1	<i>Menu Items.....</i>	<i>14</i>
4.2.2	<i>Transceiver Settings Window:</i>	<i>15</i>
4.2.3	<i>Communications Log Window:.....</i>	<i>15</i>
4.2.4	<i>Test Tool Tabs:</i>	<i>15</i>
4.2.5	<i>Test Tool Settings Window:</i>	<i>15</i>
4.2.6	<i>Comm Status Window:.....</i>	<i>16</i>
4.3	COMMUNICATIONS SETUP	16
4.3.1	<i>Virtual Serial Port Setup</i>	<i>16</i>
4.3.2	<i>Establishing the Connection.....</i>	<i>18</i>
4.4	DESCRIPTIONS OF THE MAC TEST TOOLS	20

4.4.1	<i>RF Evaluation Tab</i>	20
4.4.2	<i>PERT Tab</i>	20
4.4.3	<i>Range Tab</i>	22
4.4.4	<i>Settings Tab</i>	23
4.4.5	<i>Low Power Tab</i>	24
4.4.6	<i>Transceiver Info Tab</i>	25
4.4.7	<i>GPIO Tab</i>	26
4.4.8	<i>ED Tab</i>	27
5	DEMONSTRATION USING TEST TOOLS	27
5.1	PREREQUISITE HARDWARE AND SOFTWARE	27
5.2	SETUP METHODS	27
5.2.1	<i>Mode A: One PC, Two Boards Connected</i>	28
5.2.2	<i>Mode B: Two PC's, Two Boards Connected</i>	28
5.2.3	<i>Mode C: One PC, One Board Connected – One Standalone</i>	28
5.3	RANGE TEST	29
5.3.1	<i>The Transmitter Connected to the PC</i>	29
5.3.2	<i>The Receiver Connected to the PC</i>	31
5.4	PERT TAB (PACKET ERROR RATE TEST)	32
6	USING THE GUI WITH THE SMAC	34
6.1	RF POWER	34
6.2	RANGE TEST	35
6.3	ENERGY SCAN	35
7	DOWNLOADING TO FLASH THROUGH THE USB	36
7.1	PREREQUISITE HARDWARE AND SOFTWARE	36
7.2	ERASING FLASH MEMORY	36
7.3	DOWNLOADING NEW FLASH IMAGE	36
8	REVISION HISTORY	40
	APPENDIX 1: USING AN EXTERNAL ANTENNA	41
	APPENDIX 2: LICENSING ARRANGEMENTS	42

1 INTRODUCTION

This document is the user guide for the California Eastern Laboratories (CEL) FreeStar Pro Evaluation Kit, (**ZFSM-201-KIT-1**). The kit is a collection of hardware and software assembled to allow a customer to design a remote sensing, AMR/AMI, home and building automation, industrial control, or security application.

1.1 KIT DESCRIPTION

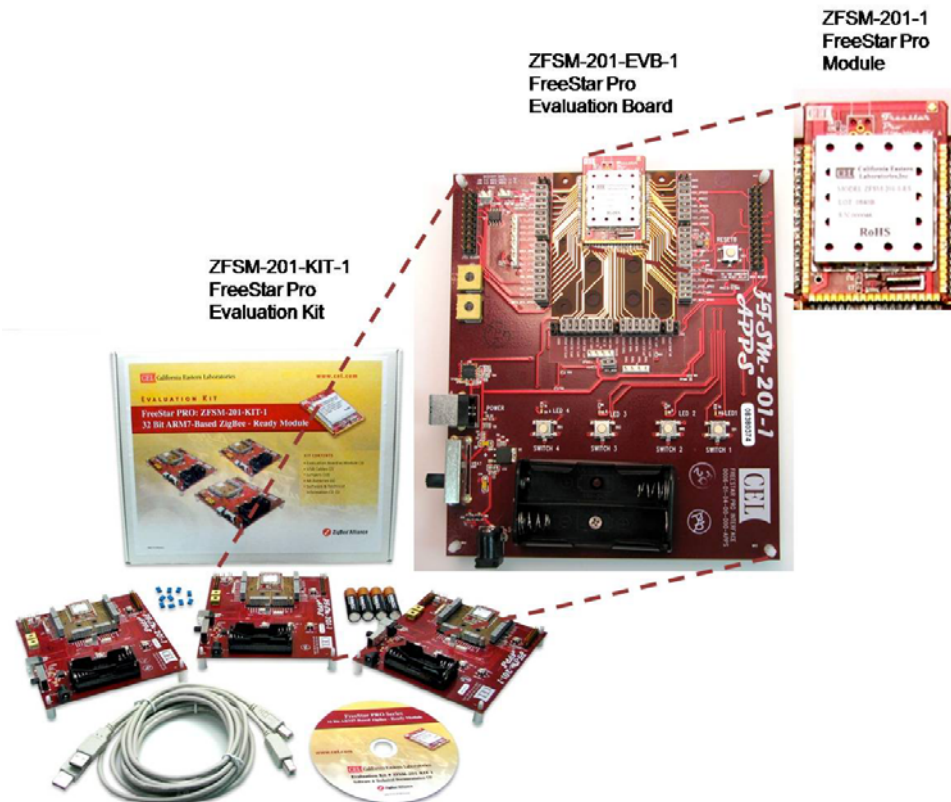

The main component in the Evaluation Kit is the **ZFSM201-EVB-1** FreeStar Pro Evaluation Board. The board serves as an interface, evaluation and development tool enabling the user to demonstrate, and evaluate the capabilities of the CEL **ZFSM-201-1**, FreeStar Pro Module. At the heart of the CEL **ZFSM-201-1** is the Freescale **MC13224V** Platform-in-Package (PiP) transceiver, a 32-bit ARM-based ZigBee radio module and a third-generation 2.4GHz IEEE® 802.15.4 platform.

The 32-bit ARM7 processor and extensive on-chip memory allows designers to eliminate the peripheral host processors often required by 8- and/or 16-bit transceiver solutions. The high level of integration also helps to reduce component count, lowering power consumption and reducing overall system cost.

The evaluation kit provides the end user the ability to quickly become familiar with both the **ZFSM-201-1** FreeStar Pro module's hardware and software. Each evaluation board comes preloaded with firmware demonstrating a wireless link and communicating with the supplied **FreeStar Pro Test Tool** Graphical User Interface (GUI).

Full application source code of the firmware is based on Freescale's SMAC and MAC

codebases for ARM7® are supplied in an IAR Embedded Workbench for ARM project. The source code exercises key features of the MC13224V and provides a good reference or starting point for creating custom applications on the SMAC codebase.

NOTE: The *MACPHY.A* library file has been removed from the pre-programmed Freescale MAC example project. The user will need to install the Freescale BeeKit™ and agree to the Terms and Conditions to receive the *MACPHY.A* library file.

Both applications include the following features:

- RF Evaluation
- Range Test Application
- Packet Error Rate Test (PERT) Application
- Transmitting and receiving on the UART
- Using low power modes
- Reading and writing to Non-Volatile Memory (NVM)
- Reading Analog to Digital Converters
- Using GPIOs

1.2 ZFSM-201-KIT-1 CONTENTS

Qty	Part Number	Description
3	ZFSM-201-EVB-1	FreeStar Pro Evaluation Boards (with firmware loaded)
2	94611-6 2.0 ver. A-B M/M 6'	USB interface cables
4	Any	Type AA Batteries
10	3M 929955-06 (0.1" SHUNT JUMPER)	Shorting Jumpers
1	CEL #0006-03-00-00-000	CEL Informational CD

The CEL Informational CD contains:

- CEL Documentation (See list in Section 1.3)
- Set-up files for the **FreeStar Pro Test Tool** program
- Sample Project files
 - A Project File for **IAR Workbench®**
 - A Solution File for **BeeKit™**
 - Application Firmware files for the **ZFSM-201-1** Module
- Files for loading the Freescale **BeeKit™** and **Test Tool**

1.2.1 Optional Hardware and Software

Manufacturer/Part Number	Description
Hardware Components	
Manufacturer: Phihong P/N: PSA05R-090-R	9V DC 0.5A Power Supply
Manufacturer: IAR Systems P/N: JLINK ARM	IAR J-Link for ARM Debug Probe (recommended for development)
Software Components	
Manufacturer: IAR Systems Name: EWARM	IAR Embedded Workbench® IDE – Development and Compiler software (required for development)
Manufacturer: Freescale Name: BeeKit	BeeKit™ – Freescale Wireless Connectivity Toolkit

1.3 REFERENCED DOCUMENTS

Table 1 contains the documents that have been referenced by this document (or recommended as additional information). Please consult the appropriate website to check for the latest revisions and editions.

Table 1 – Related and Referenced Documents

Document Title	Document Name / Number
Freescale Semiconductor Documents (www.freescale.com)	
BeeKit™ Wireless Connectivity Toolkit Quick Start Guide	BKWCTKQSG
BeeKit™ Wireless Connectivity Toolkit User's Guide	BKWCTKUG
BeeKit™ Wireless Connectivity Toolkit Software Release Notes	BKWCTKRN
MC13224V Datasheet	MC1322x
MC1322x Reference Manual	MC1322xRM
MC1322x Software Driver Reference Manual	22XDRVRRM
MC1322x Simple Media Access Controller (SMAC) Reference Manual	22xSMACRM
802.15.4 Media Access Controller (MAC) MyWirelessApp	802154MWAUG
802.15.4 Media Access Controller (MAC) MyStarNetworkApp	802154MSNAUG
802.15.4 MAC PHY Software Reference Manual	802154MPSRM
Simple Media Access Controller (SMAC) User's Guide	SMACRM
Freescale Test Tool User's Guide	TTUG
Note: The Freescale documents listed above will be loaded to the user's PC when installing the BeeKit™ Toolkit found on the CEL Freestar Pro CD	
CEL Documents (www.cel.com)	
ZFSM-201-1 Datasheet	0006-00-07-00-000
ZFSM-201-KIT-1 Development Kit User Guide	0006-00-08-00-000
ZFSM-201-EVB-1 Evaluation Board Host Serial & RF Protocol Guide	0006-00-08-01-000
ZFSM-201-EVB-1 Evaluation Board SMAC Programmers Guide	0006-00-08-02-000
ZFSM-201-EVB-1 Evaluation Board BeeKit™ Porting Guide	0006-00-08-03-000
ZFSM-201-EVB-1 Evaluation Board MAC Programmers Guide	0006-00-08-05-000
ZFSM-201-KIT-1 Wireless UART Application User Guide	0006-00-08-06-000
ZFSM-201-KIT-1, ZFSM-201-EVB-1 Erratum	0006-00-08-04-000
Note: The CEL documents listed above are included on the CEL CD.	

2 HARDWARE OVERVIEW

2.1 ZFSM-201-EVB-1 OVERVIEW

The **ZFSM-201-1** FreeStar Pro module is a 2.4GHz IEEE 802.15.4 compliant data transceiver module (based on the Freescale **MC13224V**) with a 100mW power amplifier providing enhanced range performance. Two crystals needed for the clock oscillators are also incorporated into the module. The module also contains an integrated PCB trace antenna and possesses the ability to optionally add an MMCX connector in order to use an external antenna. The procedure for adding the connector is located in APPENDIX 1: USING AN EXTERNAL ANTENNA at the end of this document.

In order to interface with the module, it has been mounted to a PCB to produce a **ZFSM-201-EVB-1** Evaluation Board as pictured in Figure 1.

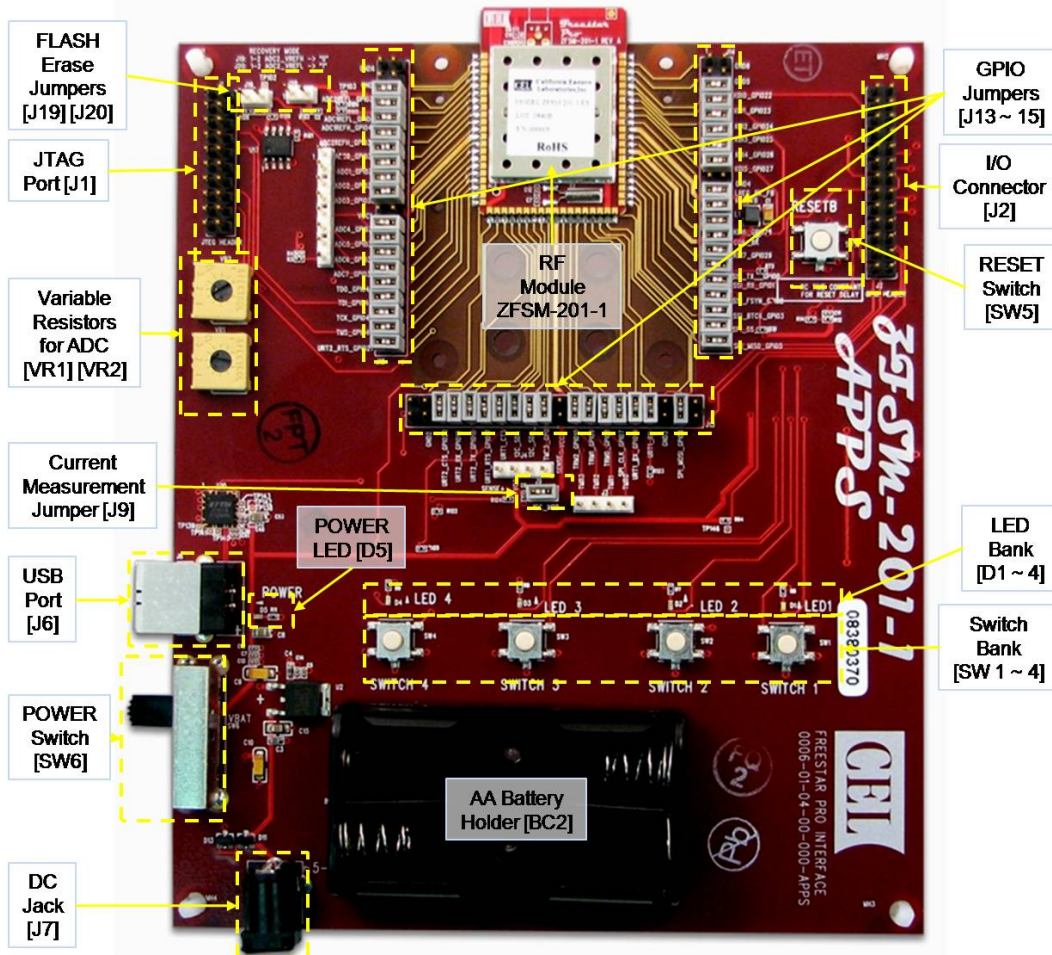

Figure 1 – Photo, ZFSM-201-EVB-1 Evaluation Board (top view)

2.2 DESCRIPTION OF THE MAJOR COMPONENTS – ZFSM-201-EVB-1

2.2.1 Input Power:

The device can be powered using any of three different methods:

- Through the **USB Port [J6]** using the supplied USB cable
- Through the **DC Jack [J7]** using an optional DC Power Supply
- Through the **Battery Holder [BC2]** using two supplied AA batteries

2.2.2 Power Switch [SW6]:

The Power Switch applies power from the chosen power source to the evaluation board. It is a three position switch with the three positions being OFF → 'V BAT' (ON for battery operation) → ON (for USB or DC Jack connections)

2.2.3 Power LED [D5]

This Red LED is connected to input power bus and will be illuminated when power is applied.

2.2.4 Current Measurement Jumper [J9 2-pin]

The jumper on J9 can be removed and a current meter placed in series to measure current into the module, a useful feature for evaluating low-power modes.

2.2.5 JTAG Port [J1 20-pin]:

The JTAG port is used for debugging applications and loading firmware using the **IAR Embedded Workbench® IDE** program.

Table 2 – JTAG Port Connector pins

Description	Pin	Pin	Description
VCC	1	2	VCC
<i>not connected</i>	3	4	GND
TDI	5	6	GND
TMS	7	8	GND
TCK	9	10	GND
RTCK	11	12	GND
TDO	13	14	GND
DBGRRQ	15	16	GND
DBGACK	17	18	GND
<i>not connected</i>	19	20	GND

2.2.6 Variable Resistors [VR1 & VR2]:

The onboard potentiometers are connected to the Analog to Digital Converter (ADC) pins on the **MC13224V**. They are used to demonstrate the functionality of the ADC.

2.2.7 FLASH Erase Jumpers [J19 2-pin, J20 2-pin]:

A method for manually erasing the Flash memory using these jumpers is discussed in Section 7.2 of this manual.

2.2.8 Reset Switch [SW5]:

The ability to reset the microcontroller on the FreeStar Pro module is provided by this switch.

2.2.9 GPIO Header Connector [J2 26-pin]

Additional access to selected I/O pins on the **MC13224V** is provided at this connector.

Table 3 – GPIO Header Connector pins

I/O	Pin	Pin	I/O
TMR1	1	2	<i>not connected</i>
VCC	3	4	GND
ADC1	5	6	ADC2
ADC3	7	8	ADC4
ADC5	9	10	<i>not connected</i>
SSI_TX	11	12	SSI_RX (GPIO1)
SSI_FSYN	13	14	SSI_BITCK
KBI0 (GPIO22)	15	16	KBI4 (GPIO26)
UART2_TX	17	18	UART2_RX
UART2_RTS	19	20	UART2_CTS
I ² C_SCL	21	22	I ² C_SDA
SPI_SCK	23	24	SPI_SS
SPI_MOSI	25	26	SPI_MISO

2.2.10 Application Switches [SW1-SW4]

User inputs for standalone demonstrations or custom applications.

2.2.11 LED's [D1-D4]

User outputs for standalone demonstrations or custom applications.

2.2.12 Timer I/O Connector [J3 4-pin]

The four Timer I/O signals are available on the J3 connector.

Table 4 – Timer I/O Connector pins

Pin 1	Pin 2	Pin 3	Pin 4
TMR0	TMR1	TMR2	TMR3

2.2.13 Supply Voltage Connector [J4 4-pin]

This connector allows powering of the EVB directly (bypassing the regulator) through Pin 3 and allows monitoring of the module's VCC through Pin 4 (SENSE+)

Table 5 – VCC Connector pins

Pin 1	Pin 2	Pin 3	Pin 4
GND (SENSE-)	GND	VCC In	VCC Module (SENSE+)

2.2.14 ADC Input Channel Connector [J5 8-pin]

The eight ADC input channels are available on the J5 connector.

Table 6 – ADC Input Channel Connector pins

Pin 1	Pin 2	Pin 3	Pin 4	Pin 5	Pin 6	Pin 7	Pin 8
ADC0	ADC1	ADC2	ADC3	ADC4	ADC5	ADC6	ADC7

2.2.15 Add on Antenna

The module contains an integrated PCB antenna and possesses the capacity to add an external antenna to the module. A simple procedure for making this change (adding the connector, changing the position of a capacitor) is included in APPENDIX 1: USING AN EXTERNAL ANTENNA located at the end of this document.

2.2.16 GPIO Jumpers [J13 40-pin, J14 40-pin, J15 40-pin]:

Three 40-pin jumper connectors provide access to the I/O pins of the **ZFSM-201-1** FreeStar Pro module and as a result to most of the I/O pins of the Freescale **MC13224V** device.

Table 7 below shows the connections made by each jumper for each of the three connectors J13, J14 and J15 as shown in Figure 2.

**Figure 2 – Pin numbering for the 40-pin Jumper Connectors (J13, J14 and J15)**

Table 7 – Jumper Connections Map

Connection to the Module/IC					Connector Pins		Connection on the EVB
Pin #		GPIO #	Description	Pin Name	#	#	<i>designates Jumper³</i>
IC ¹	Mod ²						
Jumper Connections, J14							
86	59	-	Ground	GND8	1	2	both pins hard wired to ground
79	58	-	Ground	GND5	3	4	both pins hard wired to ground
42	57	22	Keyboard Interface Bit 0	KBI0	5	6	pin 15, J2(GPIO Header)
41	56	23	Keyboard Interface Bit 1	KBI1	7	8	LED1
40	55	24	Keyboard Interface Bit 2	KBI2	9	10	LED2
39	54	25	Keyboard Interface Bit 3	KBI3	11	12	LED3
38	53	26	Keyboard Interface Bit 4	KBI4	13	14	SW1; pin 16, J2(GPIO Header)
37	52	27	Keyboard Interface Bit 5	KBI5	15	16	SW2
78	51	-	Ground	GND4	17	18	both pins hard wired to ground
44	50	-	Voltage Input to Onboard Regulators, Buck Regulator Feedback Voltage	LREG_BK_FB	19	20	connected to pin 26 through an inductor
51	49	-	System Reset Input	RESETB	21	22	RESET (SW5)
36	48	28	Keyboard Interface Bit 6	KBI6	23	24	SW3
43	47	-	Buck Converter Coil Drive Output	COIL_BK	25	26	connected to pin 20 through an inductor
35	46	29	Keyboard Interface Bit 7	KBI7	27	28	SW4
34	45	0	SSI TX Data Output	SSI_TX	29	30	pin 11, J2(GPIO Header)
33	44	1	SSI RX Data Input	SSI_RX	31	32	LED4; pin 12, J2(GPIO Header)
32	43	2	SSI Frame Sync	SSI_FSYN	33	34	pin 13, J2(GPIO Header)
31	42	3	SSI Bit Clock (bidirectional)	SSI_BITCK	35	36	pin 14, J2(GPIO Header)
30	41	4	SPI Port Slave Select	SPI_SS	37	38	pin 24, J2(GPIO Header)
29	40	5	SPI Port Master In Slave Out	SPI_MISO	39	40	pin 26, J2(GPIO Header)
Jumper Connections, J13							
<i>No Connection</i>					1	2	
28	39	6	SPI Port Master Out Slave In	SPI_MOSI	3	4	pin 25, J2(GPIO Header)
77	38	-	Ground	GND3	5	6	both pins hard wired to ground
19	37	15	UART1 RX Data Input	UART1_RX	7	8	pin 30, U10(USB to UART IC) through 1K Ω
20	36	14	UART1 TX Data Output	UART1_TX	9	10	pin 2, U10(USB to UART IC) through 1K Ω
27	35	7	SPI Port Clock	SPI_SCK	11	12	pin 23, J2(GPIO Header)
26	34	8	Timer 0 IO Signal	TMR0	13	14	pin 1, J3(Timers Conn)
25	33	9	Timer 1 IO Signal	TMR1	15	16	pin 2, J3(Timers Conn)
24	32	10	Timer 2 IO Signal	TMR2	17	18	pin 3, J3(Timers Conn)
45	31	-	Supply Voltage to Buck Regulator, switching MOSFETS & IO buffers	VCC2	19	20	both pins hard wired to Vcc
23	30	11	Timer 3 IO Signal	TMR3	21	22	pin 4, J3(Timers Conn)
22	29	12	I ² C Bus Clock	I2C_SCL	23	24	pin 21, J2(GPIO Header)
21	28	13	I ² C Bus Data	I2C_SDA	25	26	pin 22, J2(GPIO Header)

¹ The pin number on the Freescale **MC13224V** of the function listed.

² The pin number on the CEL **ZFSM-201-1** Free Star Pro Module of the function listed.

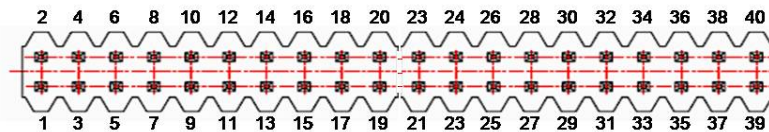
³ The **dark gray** color in the Connector Pins columns designates that a Jumper was in place at this location at shipment and should be in place for normal operation.

Connection to the Module/IC					Connector Pins		Connection on the EVB
Pin #		GPIO #	Description	Pin Name	#	#	<i>designates Jumper³</i>
IC ¹	Mod ²						
18	27	16	UART1 Clear to Send Output	UART1_CTS	27	28	pin 8, U10(USB to UART) through 1K Ω
17	26	17	UART1 Request to Send Input	UART1_RTS	29	30	pin 32, U10(USB to UART) through 1K Ω
16	25	18	UART2 Tx Data Output	UART2_TX	31	32	pin 17, J2(GPIO Header)
15	24	19	UART2 Rx Data Input	UART2_RX	33	34	pin 18, J2(GPIO Header)
14	23	20	UART2 Clear to Send Output	UART2_CTS	35	36	pin 20, J2(GPIO Header)
76	22	-	Ground	GND2	37	38	both pins hard wired to ground
			<i>No Connection</i>		39	40	
<u>Jumper Connections, J15</u>							
13	21	21	UART2 Request to Send Input	UART2_RTS	1	2	pin 19, J2(GPIO)
12	20	46	JTAG Test Mode Select Input	TMS	3	4	pin 7, J1(JTAG)
11	19	47	JTAG Test Clock Input	TCK	5	6	pin 9, J1(JTAG)
10	18	48	JTAG Test Data Input	TDI	7	8	pin 5, J1(JTAG)
9	17	49	JTAG Test Data Output	TDO	9	10	pin 13, J1(JTAG)
8	16	37	ADC Analog Input Channel 7	ADC7	11	12	pin 8, J5(ADC)
7	15	36	ADC Analog Input Channel 6	ADC6	13	14	pin 7, J5(ADC)
6	14	35	ADC Analog Input Channel 5	ADC5	15	16	pin 6, J5(ADC); pin 9, J2(GPIO)
5	13	34	ADC Analog Input Channel 4	ADC4	17	18	pin 5, J5(ADC) ; pin 8, J2(GPIO)
45	12	-	Supply Voltage to Buck Regulator, switching MOSFETS & IO buffers	VCC1	19	20	both pins hard wired to VCC
4	11	33	ADC Analog Input Channel 3	ADC3	21	22	pin 4, J5(ADC) ; pin 7, J2(GPIO)
3	10	32	ADC Analog Input Channel 2	ADC2	23	24	pin 3, J5(ADC) ; pin 6, J2(GPIO)
2	9	31	ADC Analog Input Channel 1	ADC1	25	26	pin 2, J5(ADC) ; pin 5, J2(GPIO)
1	8	30	ADC Analog Input Channel 0	ADC0	27	28	pin 1, J5(ADC)
64	7	38	High Ref Voltage for ADC2	ADC2_VREFH	29	30	pin 2, J19 (Flash Erase)
63	6	40	High Ref Voltage for ADC1	ADC1_VREFH	31	32	R105 to GND
62	5	41	Low Ref Voltage for ADC1	ADC1_VREFL	33	34	pin 8, U17
61	4	39	Low Ref Voltage for ADC2	ADC2_VREFL	35	36	pin 1, J20 (Flash Erase)
75	3	-	Ground	GND1	37	38	both pins hard wired to ground
84	2	-	Ground	GND6	39	40	both pins hard wired to ground

3 ZFSM-201-EVB-1 STANDALONE DEMONSTRATIONS (w/o PC Connection)

3.1 TRANSMISSION/RANGE DEMONSTRATION

The following demonstration can be performed using two powered **ZFSM-201-EVB-1** Evaluation Boards. No PC is required to perform this test.

- 1) Power each of the evaluation boards by one of three methods (USB, battery or DC Jack).
- 2) Switch the Power Switch '**SW6**' so that the Red Power LED (D5) turns on.
- 3) LED's 1 through 4 should all turn on and then turn off in sequence.

3.1.1 The Transmitter Setup

- 4) Pressing '**SWITCH 1**' puts the device into '**Transmit Range**' mode where the device will continually send out RF packets. The following parameters are set automatically when the switch is pressed:
 - o The ID of the device is set to '**1010**'.
 - o The channel is set to '**13**'.
 - o The power is set to maximum for the transmitted range message, '**18**' (20dBm).
 - o The device transmits a periodic range message (approx 200/min) and blinks LED1 for each transmission.
- 5) Between transmissions, the device switches to '**Receive Ack**' mode where it waits to receive an RF acknowledgment from the receiver.
- 6) If a valid acknowledgment response is received, the device will blink LED2 once for each receipt.

3.1.2 The Receiver Setup

- 7) Pressing '**SWITCH 2**' puts the device into '**Receive Range**' mode where the device continually listens for RF packets on its channel. The following are set automatically when the switch is pressed:
 - o The ID of the device is set to '**2020**'.
 - o The channel is set to '**13**'.
 - o The power is set to maximum for the transmission of the acknowledgment message, '**18**' (20dBm).
 - o If a valid message is received, the device will blink LED2 for each receipt of the message.
- 8) The device then switches to '**Transmit Ack**' mode where it transmits an acknowledgement message back to the source and blinks LED1.

3.1.3 Transmission Indicators

- 9) If the Transmitter is setup before the Receiver, the Transmit board will blink LED1 only, until the Receiver is setup. It will then blink both LED1 and LED2, as will the Receiver board.
- 10) If the Receiver is setup first, it will blink LED2 once, and then wait until the Transmitter is setup. Then both boards will blink both LED1 and LED2.

3.1.4 Testing the Range

Testing the range in the standalone mode can be done by separating the two boards until the Receiver board stops blinking. However, more effective range demonstrations are described later on in this document (Section 5.3 and 5.4).

3.2 ADC DEMONSTRATION

This demonstration requires only one powered **ZFSM-201-EVB-1** evaluation board; no PC is required.

- 1) Locate the two Variable Resistors (VR1 and VR2) on the board.

- 2) Adjusting VR1 will adjust the brightness of LED2, which will remain illuminated for about 2 seconds after the last adjustment.
- 3) Adjusting VR2 will adjust the brightness of LED1; it too will remain illuminated for about 2 seconds.

4 FREESTAR PRO TEST TOOL SOFTWARE

The **FreeStar Pro Test Tool** evaluation software was designed to give the developer the ability to quickly test features built into the **ZFSM-201-1** FreeStar Pro module. The underlying UART communications can also be used to incorporate automated manufacturing tests. The **FreeStar Pro Test Tool** evaluation software is described in the following sections.

4.1 SOFTWARE INSTALLATION AND SETUP

4.1.1 Prerequisites to Installation

CEL strongly recommends the disabling of any anti-virus software during the installation of the software. Anti-virus software may be re-enabled once the installation has completed. As certain driver files may change during installation, close all other applications in order to properly install the software.

4.1.2 Installation

Insert the CD into the drive and double-click the '**setup.exe**' file in the directory \ZFSM-201\Tools\FSPPT v1.5\ for the SMAC and/or MAC demo.

- 1) The installer will launch automatically. Follow the instructions to install the program.
- 2) When the installation is complete, a shortcut to the program will be created on the desktop. Double click the shortcut to open the **FreeStar Pro Test Tool** program. The screen in Figure 3 will appear:

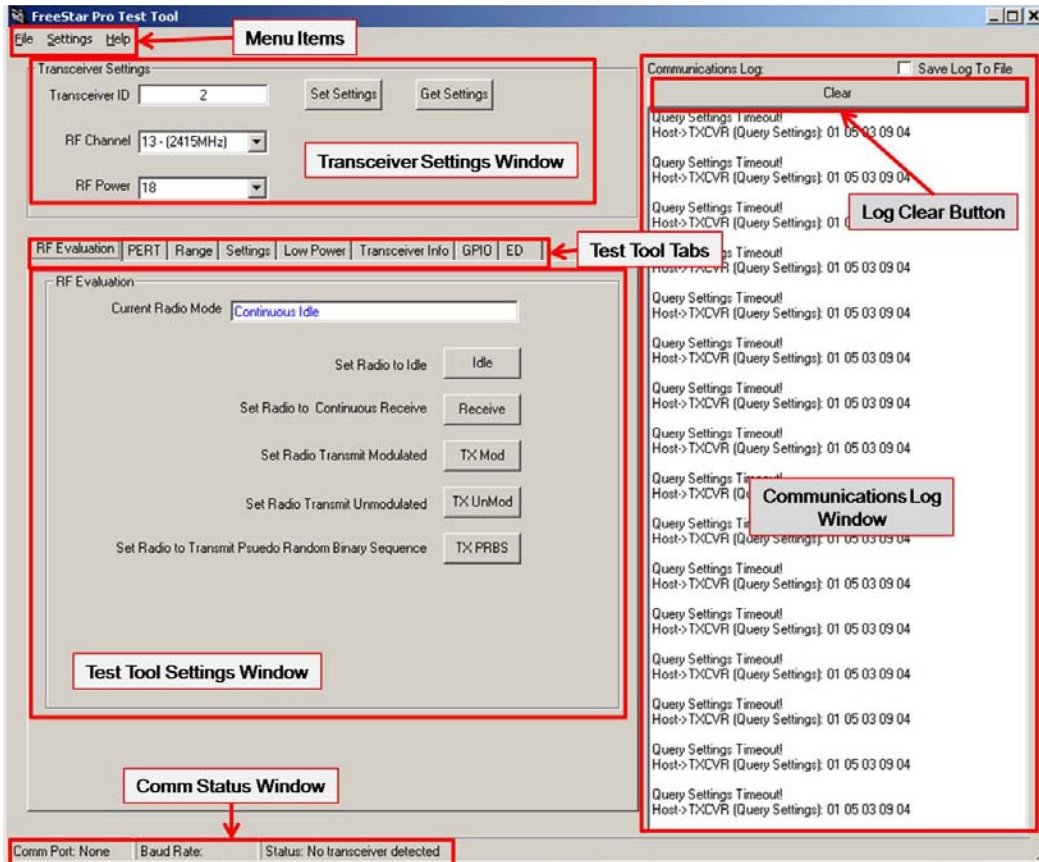

Figure 3 – Screen, FreeStar Pro Test Tool (Opening)

4.2 GUI SCREEN DESCRIPTIONS

Please refer to Figure 3 to become familiar with the screen location of each of the following areas, commands, and functions:

4.2.1 Menu Items

The major commands in the header menu bar of the opening screen

- **File**
 - **New:** To create a new file.
 - **Open:** To open an existing file.
 - **Exit:** To exit the program.
- **Settings**
 - **Communications...:** To set up the serial communications link with an evaluation board
- **Help**
 - **About FreeStar Pro Test Tool:** Additional information about the program.

4.2.2 Transceiver Settings Window:

Sets the parameters of the **ZFSM-201-EVB-1** FreeStar Pro evaluation board attached to the PC by a USB cable.

- **Transceiver ID:** Enter the ID of the transmitter (1-65,535)
- **RF Channel:** Enter the RF channel (11: 2405MHz ~ 26: 2480MHz).
- **RF Power:** Adjusts the Power Level of the Device from +5 to +20dBm (settings of 0 ~ 18)
- **Set Settings:** Writes the 'Transceiver ID', 'RF Channel', and 'RF Power' to the Flash memory of the module attached to the evaluation board
- **Get Settings:** Reads the 'Transceiver ID', 'RF Channel', and 'RF Power' from the Flash memory of the module attached to the evaluation board.

4.2.3 Communications Log Window:

All supported UART messages sent and received by the PC will be displayed.

- See "**ZFSM-201-EVB-1 Module, Host and RF Protocol Guide**" (CEL Doc #0006-00-08-01-000) for a detailed list of supported messages and their frame formats.
- Messages are listed with the most current on the top
- Clicking the 'Clear' button will clear all messages in the log.
- Checking the 'Save to Log' file will open a New save window. To save the log file, choose the appropriate directory and click 'Save'.

4.2.4 Test Tool Tabs:

The individual test tools available in the **FreeStar Pro Test Tool** software titled:

- **RF Evaluation** (Section 4.4.1): Sets the mode of a single module for RF testing.
- **PERT** (Section 4.4.2): Performs a Packet Error Rate Test on a pair of modules.
- **Range** (Section 4.4.3): Sets up a single or periodic transmission between two modules.
- **Settings** (Section 4.4.4): Queries the reference oscillator capacitor values and the ADC values on the evaluation board.
- **Low Power** (Section 4.4.5): Allows the user to put the evaluation board into various Sleep modes for testing; enables the on-chip Buck Regulator (a hardware change is needed also) See "**ZFSM-201-KIT-1, ZFSM-201-EVB-1 Errata**" (CEL Doc #0006-00-08-04-000) for further information on the Buck Regulator.
- **Transceiver Info** (Section 4.4.6): Reads firmware versions and transceiver statistics.
- **GPIO** (Section 4.4.7): Reads or sets selected GPIO Outputs.
- **ED** (Section 4.4.8): Performs an energy scan of the IEEE 802.15.4 2.4GHz channels.

4.2.5 Test Tool Settings Window:

This area changes depending on the 'Test Tool Tab' selected. Please see individual descriptions in Section 4.4.

4.2.6 Comm Status Window:

The status bar at the bottom of the screen showing:

- **Comm Port:** The PC COM port number through which the evaluation board is connected (or none).
- **Baud Rate:** The speed of the connection from the PC to the evaluation board
- **Status:** The connection status of the evaluation board:
 - **'Status: No transceiver detected'**
 - **'Status: Found FreeStar Pro Module'**

4.3 COMMUNICATIONS SETUP

4.3.1 Virtual Serial Port Setup

- 1) Attach a USB cable (supplied) between the **ZFSM-201-EVB-1** and the PC.

Note: It is strongly recommended that the USB cable be plugged directly into the PC and not through a USB Hub to avoid COM port conflicts.

The first time a ZFSM-201-EVB-1 FreeStar Pro Evaluation Board is connected to a computer, the PC will install virtual serial port drivers and a COM port number will be assigned to the evaluation board. To check which COM port is assigned to the USB connection follow steps 2) through 5):

- 2) Open the Windows **'System Properties'** window using **'Start'->'Control Panel' ->'System'** or right click on **'My Computer'** in the **'Start'** menu and select **'Properties'** from the drop down menu.
- 3) In the **'System Properties'** window under the **'Hardware'** tab, click the **'Device Manager'** button as indicated in Figure 4.

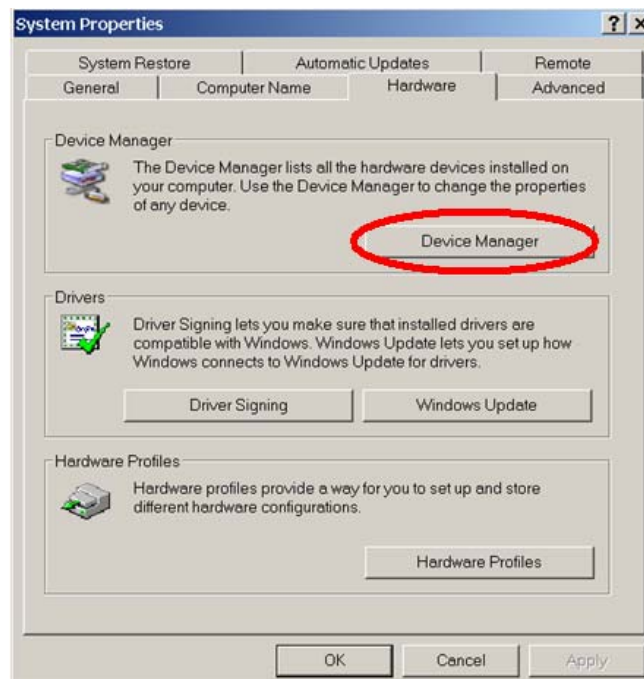

Figure 4 – Screen, Windows System Properties

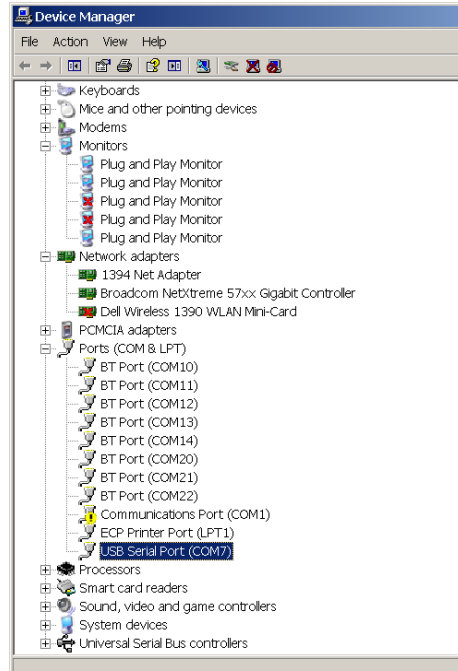

Figure 5 – Screen, Device Manager

- 4) Click on the **'Ports (COM & LPT)'** label or expand the tree by clicking the **'+'** sign. The COM ports in the system will be displayed as shown in Figure 5.
- 5) As shown in Figure 5, the COM port chosen by the system is displayed as **'USB Serial Port (COM7)'**. Only COM ports 1-16 should be used with the **FreeStar Pro Test Tool**. If a COM port greater than 16 has been selected by the system follow steps 6) through 8):
- 6) Double click on the **'USB Serial Port'** in the **'Device Manager'** window shown in Figure 5.
- 7) The window shown in Figure 6 will appear. Select the **'Port Settings'** tab and click the **'Advanced'** button.

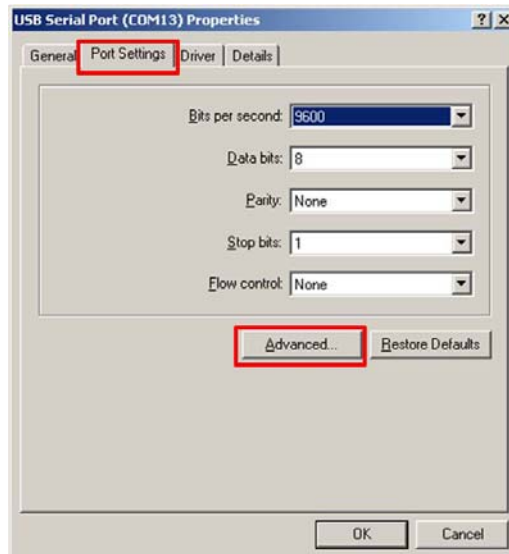

Figure 6 – Screen, Device Manager – Port Settings

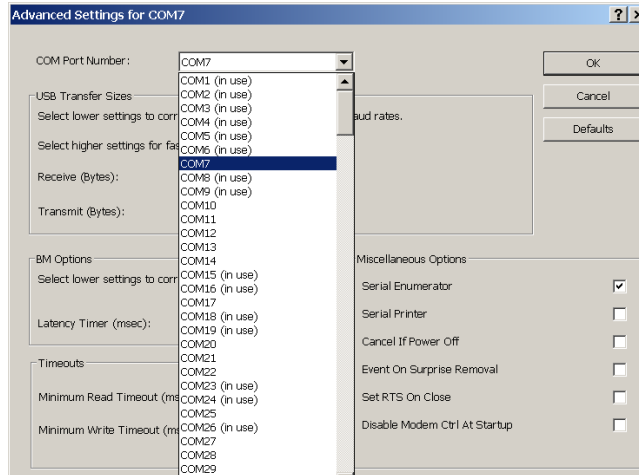

Figure 7 – Screen, Device Manager – COM Port Setting

- 8) Click the ‘**COM Port Number**’ drop down menu and select a COM Port (not in use) between 1 and 16 as shown in Figure 7.

Note: If all COM Ports between 1 and 16 are shown as ‘(in use)’ and one of them is not physically being used, it can be assigned.

4.3.2 Establishing the Connection

If the bottom status bar shows ‘**Comm Port: None**’, then the test tool was not able to find a FreeStar Pro module on any of the available PC COM ports.

- 1) Click on the ‘**Settings**’ menu and click the ‘**Communications**’ Pull down entry as shown in Figure 8. The screen shown in Figure 9 will appear.

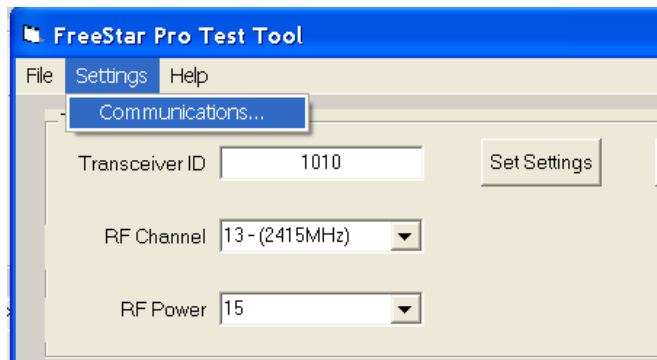

Figure 8 – Screen, Test Tool – Communications Settings

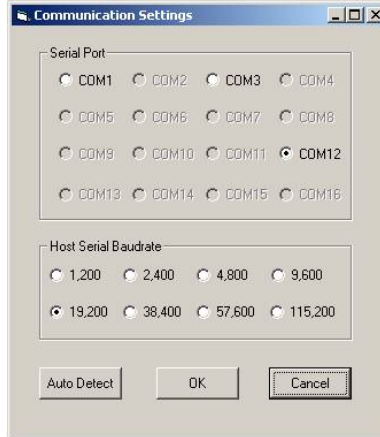

Figure 9 – Screen, Test Tool – Port & Baud Rate Settings

- 2) The default baud rate should be set correctly at **'19,200'** baud. Check that the correct serial port is identified and click **'OK'**. The status bar should appear as in Figure 10.

When the connection with the module has been successful, the Communications Status Window will show the COM port number, the baud rate, and the **'Status: Found FreeStar Pro Module'** as shown in Figure 10.



Figure 10 – Screen, Test Tool – Comm Status Window (Connected)

If the Comm Status Window displays another message, click on the **'Settings'** menu and click the **'Communications'** Pull down entry.

- 3) If the COM port in use is not shown or not known, select **'Auto Detect'**. If **'Auto Detect'** is successful the status bar will display a COM port number and a baud rate as in Figure 11 below. Repeat steps 1) and 2) until the correct status (as in Figure 10) is displayed in the **'Comm Status Window'**.



Figure 11 – Screen, Test Tool – Comm Status Window (COM Port Found)

- 4) If communication with the module is still unsuccessful with correct settings, restart the test tool, and perform the steps outlined above.

When connected to the FreeStar Pro Test Tool program the Indicator LED's 1 through 4 will convey the following information:

- LED4 blinks when UART messages sent from the Host PC are received on the evaluation board.
- LED3 blinks when UART messages are sent from the evaluation board to the Host PC.
- LED2 blinks when the evaluation board receives a message through the RF channel.
- LED1 blinks when the evaluation board transmits a message through the RF channel.

4.4 DESCRIPTIONS OF THE MAC TEST TOOLS

Eight different tools are available in the *Free Star Pro Test Tool* program provided on the CEL CD and are shown as Tabs in the program's opening screen.

4.4.1 RF Evaluation Tab

The RF Evaluation Tab is used to set the module to run in different modes for RF Evaluation Tests, commonly used for FCC certification or other RF evaluation.

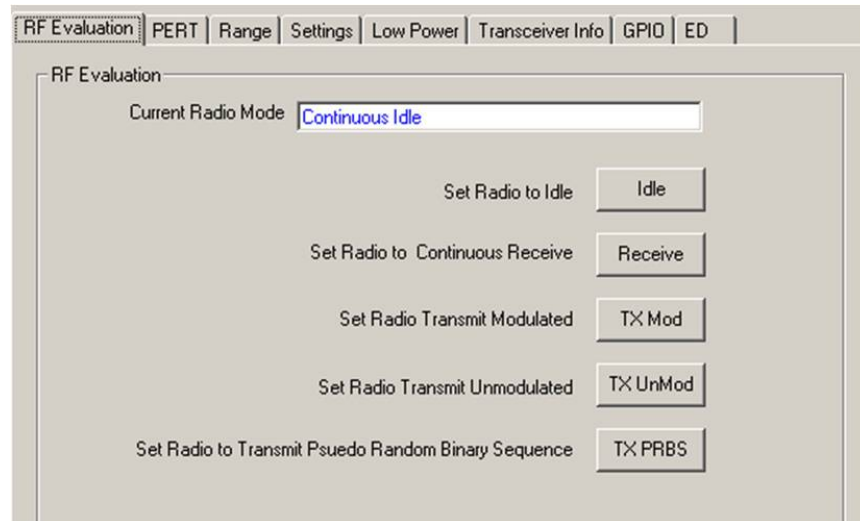

Figure 12 – Screen, Test Tool – RF Evaluation Modes

- **Idle:** Sets the radio to Idle mode where the reference oscillator is operating, but the radio is neither transmitting nor receiving.
- **Receive:** The radio will continually receive RF messages. In this mode any RF messages received will be ignored by the processor.
- **TX Mod:** The radio will continually transmit a Modulated signal.
- **TX UnMod:** The radio will continually transmit an Unmodulated signal.
- **TX PRBS:** The radio will continually transmit a Psuedo Random Binary Sequence.

4.4.2 PERT Tab

The Packet Error Rate Test is conducted between two evaluation boards, one configured as a transmitter and the other as a receiver. It sends a defined number of packets (with a defined message code) from the transmitter to the receiver. The receiver counts the number of packets received with the same message code and displays the statistics. A demonstration of this function is given in Section 5.4 of this document.

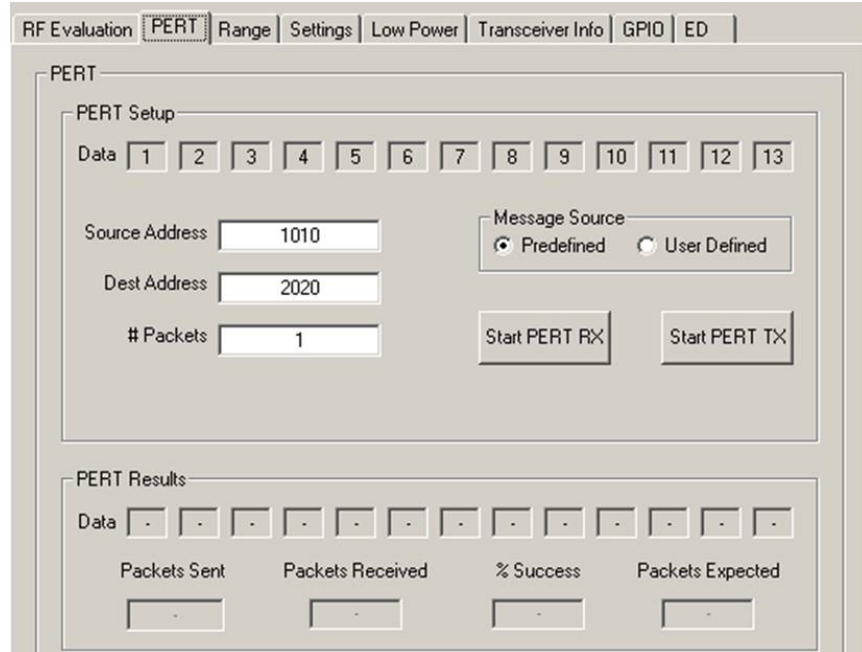

Figure 13 – Screen, Test Tool – PERT Test

4.4.2.1 PERT Setup Section

- **Data:** The message to be sent (thirteen 1-byte fields).
- **Source Address:** The ‘**Transceiver ID**’ of the evaluation board being used as the transmitter.
- **Dest Address:** The ‘**Transceiver ID**’ of the evaluation board being used as the receiver
- **# Packets:** The number of times the packet will be transmitted.
- **Message Source:** Defines the message in the data fields, as follows:
 - **Predefined:** Fills the Data fields with predefined numbers (1 ~ 13).
 - **User Defined:** Allows the user to change any of the data values (0 ~255) in the 13 ‘**Data**’ fields.
- **Start PERT RX:** Sets the receiver into a mode ready to receive packets (if the module connected to this version of the GUI is configured as the receiver); if using a User Defined Message Source, copies the data fields from the ‘**Transmitter**’ area.
- **Start PERT TX:** Starts the transmission of the specified number of packets (if the module connected to this version of the GUI is configured as the transmitter).

4.4.2.2 PERT Results Section

- **Data:** The criteria message for the error rate test (must match the transmitter data). The next four fields are filled by the test program when it is run. On starting the PERT, Packets Expected will immediately display:
- **Packets Sent:** Total number of packets sent.
- **Packets Received:** Successfully received packets (data received matched the criteria).
- **% Success:** Equal to ‘**Packets Received**’/‘**Packets Sent**’.
- **Packets Expected:** Equals the ‘**# Packets**’ from the Transmitter.

4.4.3 Range Tab

The test under this tab will set up a transmission (single or continuous) between two evaluation boards, and measure the Link Quality Indication parameter for their communications link.

Figure 14 – Screen, Test Tool – Range Test

4.4.3.1 Transmitter Section

- **Data:** The message to be sent (thirteen 1-byte fields).
- **Dest Address:** The ‘**Transceiver ID**’ of the evaluation board being used as the receiver.
- **Message Source:** Defines the message in the data fields, as follows:
 - **Predefined:** Fills the Data fields with predefined numbers (1 ~ 13).
 - **User Defined:** Allows the user to change any of the data values (0 ~255) in the 13 ‘**Data**’ fields.
- **ACK’s:** Determines whether the transmitter asks for an acknowledgement of its message, as follows:
 - **Disable:** Turns OFF the acknowledgement request.
 - **Enable:** Turns ON the acknowledgement request.
- **Rate:** Defines the transmission rate, as follows:
 - **Single:** Transmits a single packet.
 - **Continuous:** Transmits the packet repeatedly until stopped manually (i.e. can be stopped with the RESET button).
- **Transmit:** Starts the transmission of packets.

4.4.3.2 Receiver Section

- **Data:** The message being received; it should agree with the Transmit '**Data**'.
- **Source Address:** The '**Transceiver ID**' of the evaluation board being used as the transmitter.
- **RX's LQI:** The Link Quality Indicator as measured by the receiver (with indicator "light")
- **Receive:** Starts the reception of packets.

4.4.4 Settings Tab

The settings tab can be used to query the settings (capacitor values) of the reference oscillator, or to query the Analog to Digital Converters. See Figure 15.

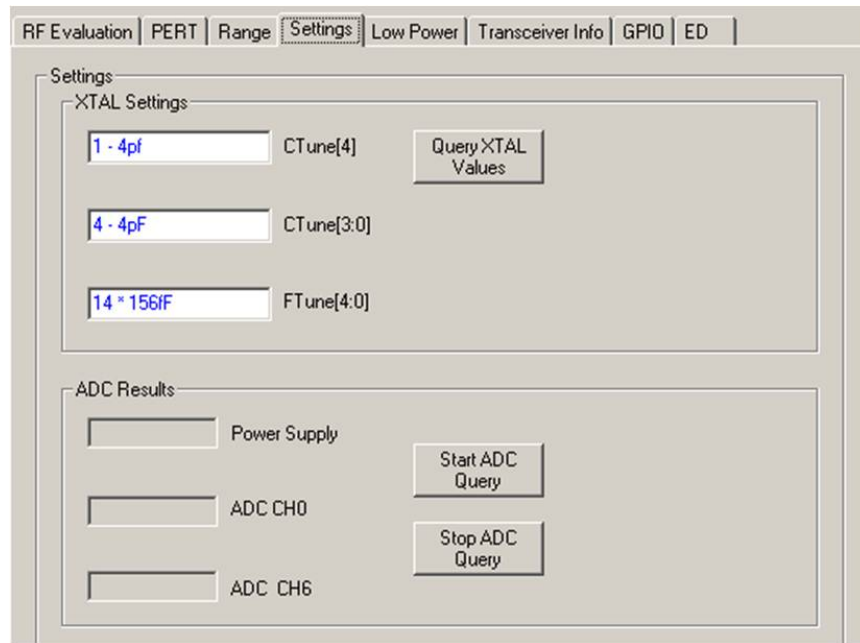

Figure 15 – Screen, Test Tool – Settings

4.4.4.1 XTAL Settings

- The default XTAL settings are hardcoded into the program and are displayed on turn on.
- Clicking the '**Query XTAL Values**' button will read the actual values in the device and display them in the drop down boxes. Packets sent and received can be seen in the Communications Log screen.

4.4.4.2 ADC Results

- By clicking the '**Start ADC Query**' button the ADC's connected to the Potentiometers (See Figure 1) will be continually read (about twice a second). Their values will be updated in the respective boxes in the GUI.
- In addition the **MC13224V** has the ability to monitor its own power supply from an internal voltage reference. This value will also be updated in the ADC query.
- Clicking the '**Stop ADC Query**' button will stop the query.

4.4.5 Low Power Tab

There are a variety of low power and wakeup options available on the **MC13224V**. The GUI allows the user to experiment with low power modes by placing the device into the selected low-power mode for 10 seconds, for a purpose such as to monitor the current into the module (using the current measurement jumper). See Figure 1 for its location.

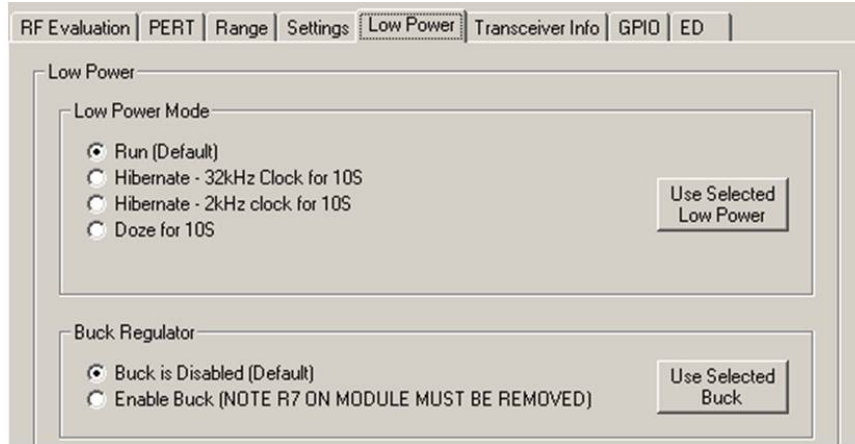

Figure 16 – Screen, Test Tool – Low Power Mode/Buck Regulator

4.4.5.1 Low Power Mode

Note: All of the 'Low Power Mode' demonstrations require that the transceiver 'Current Radio Mode' be in 'Idle' 'Receive' or 'TXUnMod' under the 'RF Evaluation' tab

- In the two Hibernate modes, the Real Time Clock (RTC) is configured as the wakeup source with either the 2 kHz internal clock or the external 32 kHz crystal used as the clock.
- In Doze mode, the reference oscillator (24 MHz) is the wakeup source.
- Run mode is normal operation.

4.4.5.2 Buck Regulator (this function is not supported by current software)

- The **MC13224V** contains an on-board Buck Regulator to further reduce operating current on battery powered devices.
- The evaluation board contains the external components needed to operate the Buck Regulator.

NOTE: FreeStar Pro Module hardware must be modified to enable the Buck Regulator.

- Check the Enable Buck/Disable Buck selection followed clicking the Use Selected Buck button. The buck will stay enabled/disabled until reset.

4.4.6 Transceiver Info Tab

Version and transceiver information can be obtained from this tab as seen in Figure 17.

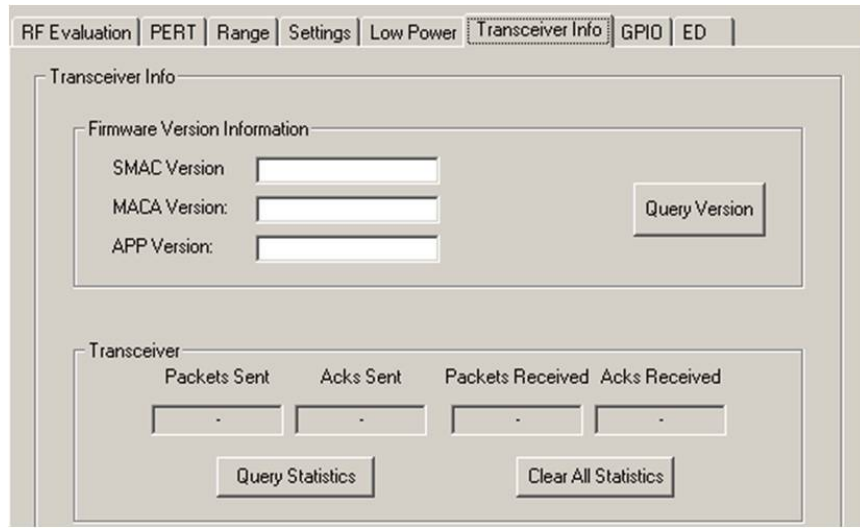

Figure 17 – Screen, Test Tool – Transceiver Info

4.4.6.1 Firmware Version Information

- The version information is updated when the evaluation board is first plugged into the host PC. It can be viewed by clicking '**Query Version**'.

4.4.6.2 Transceiver

Displays the statistics on the connected device accumulated since it was last cleared (Powering OFF or resetting the EVB do NOT clear the statistics.)

- The number of packets sent and received as well as the number of acknowledgement sent and received is tracked.
- Can be used (for example) in conjunction with the Range test to monitor the radio performance over an extended period of time.
- Clicking the '**Clear All Statistics**' button will set all data to zero.
- Clicking the '**Query Statistics**' will display the current data for the connected evaluation board.

4.4.7 GPIO Tab

The GPIO Tab can be used to set selected GPIO Outputs to logic high or logic low levels or to query the setting of the connected device.

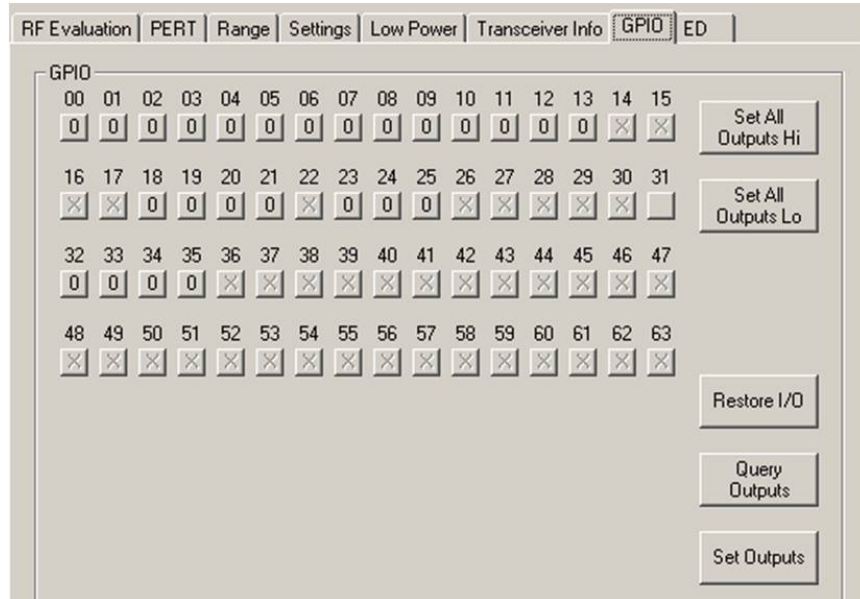

Figure 18 – Screen, Test Tool – GPIO

- The **'Set All Outputs Hi'** button will set all available GPIO outputs to a logic high level in the GUI.
- The **'Set All Outputs Lo'** button will set all available GPIO outputs to a logic low level in the GUI.
- Clicking on an individual **'GPIO'** box will toggle the output between being a logic high or logic low level.
- The **'Restore I/O'** button will restore the GPIO pins to their initial state.
- Clicking the **'Set Outputs'** button will send a UART message to the **ZFSM-201-EVB-1** evaluation board setting the selected GPIO to the state in the GUI.
- Clicking the **'Query Outputs'** button will read the output level of the **ZFSM-201-1** Module on the evaluation board and display the results in the GUI.
- The **'GPIO'** boxes containing a gray **'X'** are either not available on the module (not brought out) or used on the evaluation board for other functions (UART, ADC, ...).

NOTE: LED4 (GPIO01) and LED3 (GPIO25) are under the control of the UART state machine. Setting them to a logic level is allowed in the GUI, but the state machine will quickly take control of the LED's. The output state set by the GUI may not be what is queried for this reason.

4.4.8 ED Tab

This Tab demonstrates the ability of the module to conduct an energy scan of all of the IEEE802.15.4 2.4GHz channels, a function that can be useful when the network needs to be capable of determining its RF Channel based on the interfering signals present. The MAC software allows the duration of the energy scan to be selected. The longer the duration, the more accurate the energy scan results are, but the scan will take longer.

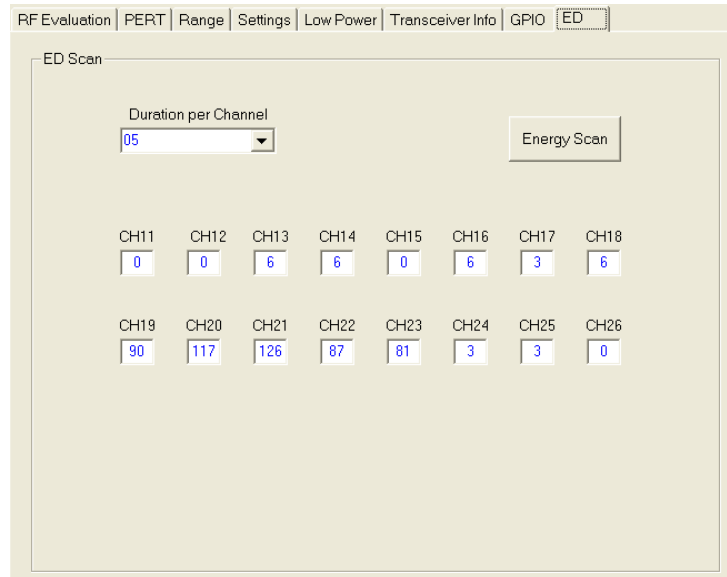

Figure 19 – Screen, Test Tool – ED Scan

5 DEMONSTRATION USING TEST TOOLS

5.1 PREREQUISITE HARDWARE AND SOFTWARE

- Two **ZFSM-201-EVB-1** FreeStar Pro Evaluation Boards
- One USB cable
- Two Type AA Batteries
- The FreeStar Pro Test Tools program loaded on a PC.

For information on downloading the FreeStar Pro Test Tools program, please refer to Section 4.1.2.

5.2 SETUP METHODS

Tests that Use Two Evaluation Boards (Range, PERT)

Three connection methods can be used for each of the next two tests, Range and PERT. For the demonstration tests that follow, Mode C configuration (described in Section 5.2.3) is used.

5.2.1 Mode A: One PC, Two Boards Connected

Two evaluation boards connected to One PC (see Figure 20).

- 1) Open two sessions of the *FreeStar Pro Test Tool* on the same computer.



Figure 20 – Diagram, Two sessions, one computer

- 2) Configure the receiver in one session and the transmitter in the other session.

5.2.2 Mode B: Two PC's, Two Boards Connected

Two evaluation boards connected to Two PC's (see Figure 21).

- 1) Open one session of the *FreeStar Pro Test Tool* on each computer.

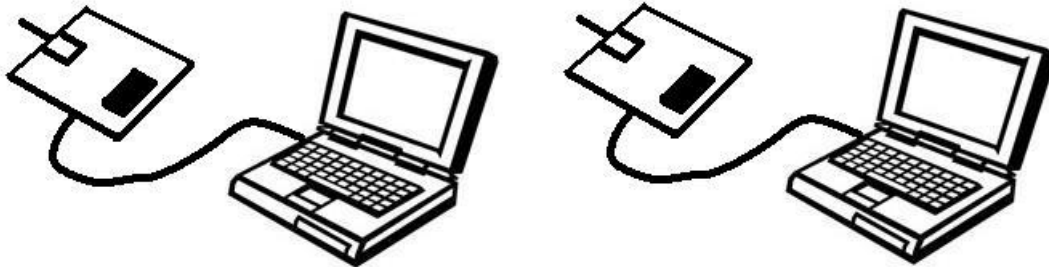

Figure 21 – Diagram, Two computers one session on each

- 2) Configure the receiver on one computer and the transmitter on the other computer.

5.2.3 Mode C: One PC, One Board Connected – One Standalone

One evaluation board connected to a PC, one board operating in standalone mode (see Figure 22).

For the demonstration tests that follow, Mode C configuration (as described here) is used.

- 1) Open a single session of the *FreeStar Pro Test Tool* on the computer.



Figure 22 – Diagram, One board wired to the computer, one linked wirelessly

- 2) For the 'Range' Test, the board connected to the computer can be configured either as the receiver or as the transmitter. For the 'PERT' Test, the board connected to the computer should be configured as the receiver. See the details in the sections (5.3 and 5.4) for each of these demonstration tests below.

5.3 RANGE TEST

The Range Tab (and the PERT Tab) can be used to determine the effect of separation of the two evaluation boards. For this demonstration, Mode C configuration (described in Section 5.2.3) is used in order to be able to separate the Transmitter evaluation board from the Receiver evaluation board to demonstrate the Link Quality Indication (LQI) of the communications link under less than ideal circumstances and as a function of range. This test, using two different methods, will be described: (5.3.1) using the connected evaluation board as a transmitter, and (5.3.2) using the connected evaluation board as the receiver.

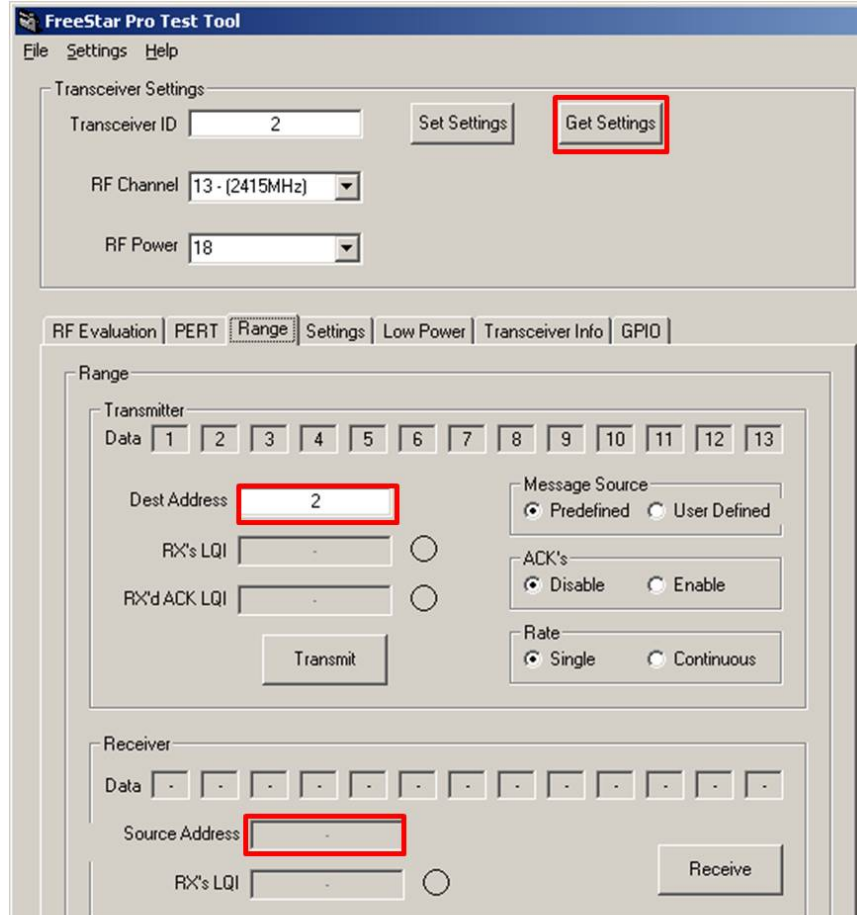



Figure 23 – Screen, Test Tool – Range Tab

5.3.1 The Transmitter Connected to the PC

- 1) Connect one of the evaluation boards to the PC through a USB cable and power up the board.
- 2) Open the FreeStar Pro Test Tool program by clicking on the icon [] on the user's desktop.
- 3) Follow connection procedures given in Section 4.3.1 until the Status is '**Found FreeStar Pro Module**'.

In the '**Transceiver Settings**' Section of the screen in Figure 23:

- 4) The '**Transceiver ID**' for the Transmitter should be set to '**1010**'.
- 5) The '**RF Channel**' should be set to Channel '**13**'.
- 6) Set the '**RF Power**' at full power '**06**'. (Note screenshot shows an SMAC configuration instead of a MAC configuration – See Section 6.1 for more information).
- 7) Click the '**Set Settings**' button to write the settings to the connected evaluation board.
- 8) In the '**Range – Transmitter**' Section of the screen in Figure 23, click '**Predefined**' in the '**Message**

Source area.

- 9) Set the (destination) '**Dest Address**' to '**2020**'.
- 10) Select '**Enable**' in the '**ACK's**' area and '**Continuous**' in the '**Rate**' area.

If ACKs are enabled the Receiver will send back an acknowledgement message which contains the Receiver's LQI. The Transmitter will calculate the LQI of the ACK message it receives.

Both LQI indications will be displayed in the boxes pictured above.

- 11) Start the Transmit Range test by clicking the '**Transmit**' button. LED 1 will blink.
- 12) Apply power to the standalone evaluation board.
- 13) Press '**SWITCH 2**' on the standalone board to start the Range Receive.
 - o The ID of the Receiver board will automatically be set to '**2020**'
 - o The RF channel of the Receiver board will be set to Channel '**13**'.
 - o The RF power of the Receiver board will be set to full power for the acknowledgment message '**18**'.
 - o The standalone board will receive the message from the Transmitter and send its LQI and ACK message back to the Transmitter.

On the transmitter board LED's 1, 2, and 3 will blink. On the receiver board, LED's 1 and 2 will blink. On the PC, a screen (such as that in Figure 24) will be displayed which will show:

- Packet messages in the 'Communications Log' window.
- 'RX's LQI' numbers (that will fluctuate) ranging from 0 to 255.
- 'RX'd LQI' numbers (that will also fluctuate) ranging from 0 to 255.
- To the right of each of the LQI numbers will be an indicator "light" which will blink with one of three colors:
 - o Green – For LQI readings of greater than 168.
 - o Yellow – For LQI readings between 85 and 168.
 - o Red – For LQI reading of less than 85.

LQI measurements will vary due to many factors including separation distance between the two evaluation boards, and obstructions in the transmission path. For example, the user can try covering the module of one of the evaluation boards with a hand to lower the LQI readings into the '**Yellow**' range and covering the modules on both boards to lower it into the '**Red**' range.

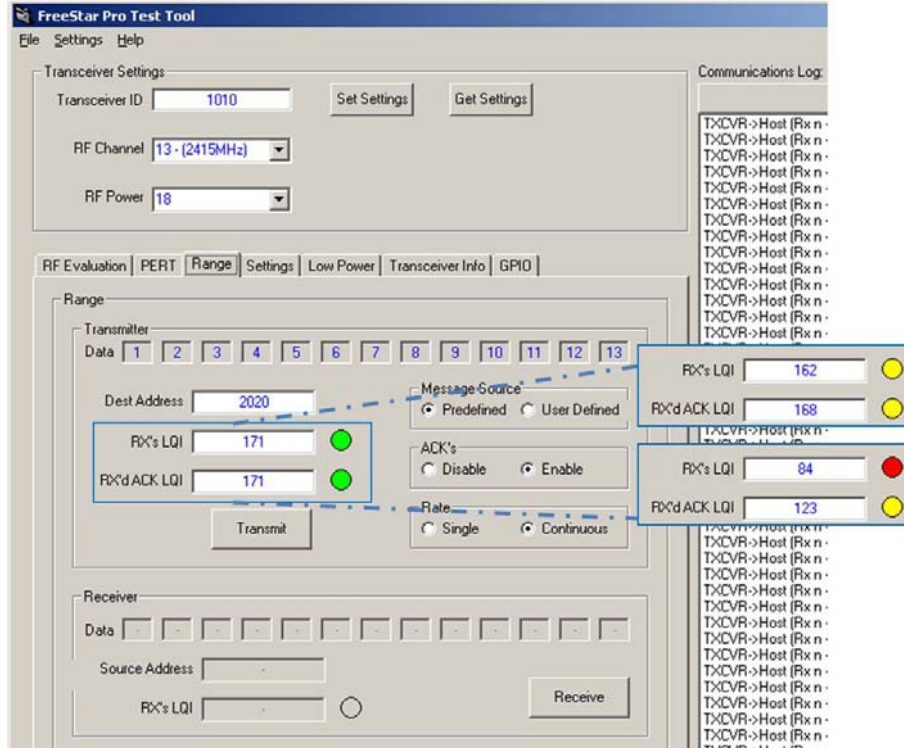

Figure 24 – Screen, Test Tool – Range TX

5.3.2 The Receiver Connected to the PC

Alternately the board connected to the PC can be configured as a receiver. Follow steps 1), 2) and 3) in section 5.3.1. In the **'Transceiver Information'** area:

- 1) Set the **'Transceiver ID'** to **'2020'**.
- 2) Set the **'RF Channel'** to **'13'**.
- 3) Set the **'RF Power'** to full power **'06'** (for the ACK message). (Note screenshot shows an SMAC configuration instead of a MAC configuration – See Section 6.1 for more information).
- 4) Click on **'Set Settings'**.

On the Standalone Board:

- 5) Press **'SWITCH 1'** on the standalone board to put the board into the Range Test, Transmit, Continuous Mode, with ACK's enabled.
 - o The ID of the Transmitter board will automatically be set to **'1010'**.
 - o The RF channel of the Transmitter board will be set to Channel **'13'**.
 - o The RF power of the Transmitter board will be set to full power, **'18'**.

The Transmitter Board will start to send out Range packets requiring ACK's indefinitely until the evaluation board is Reset or powered OFF. LED 1 will blink.

- 6) In the **'Range – Receiver'** Section of the screen in Figure 23, start the Receive test by clicking the **'Receive'** button.

On the receiver board LED's 1, 2, and 3 will blink. On the transmitter board, LED's 1 and 2 will blink. On the PC, a screen (such as that in Figure 25) will be displayed which will show:

- Packet messages in the **'Communications Log'** window.
- The **'Receiver'** area **'Data'** populated with the **'Predefined'** data.
- The **'Source Address'** of **'1010'**.

- ‘RX’s LQI’ numbers (that will fluctuate) ranging from 0 to 255.

To the right of the LQI number will be an indicator “light” which will blink any of three colors following the same criteria as with the Transmit test.

Again, the user can cause the LQI measurements to change by varying the separation distance between the two evaluation boards, or changing the obstructions in the transmission path.

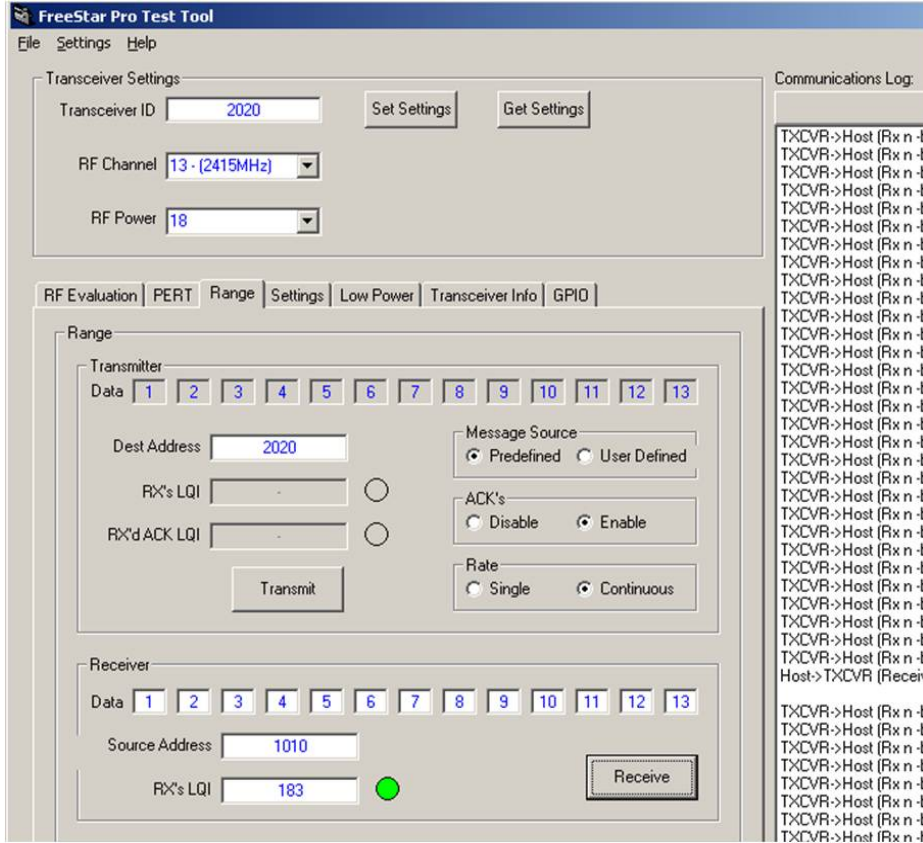

Figure 25 – Screen, Test Tool – Range RX

5.4 PERT TAB (PACKET ERROR RATE TEST)

The ‘PERT’ (Packet Error Rate Test) Tab can be used to evaluate RF performance in the user’s own environment. For this demonstration, the Mode C configuration (described in Section 5.2.3) is used in order to allow the separation of the Transmitter evaluation board from the Receiver evaluation board. This makes it possible to demonstrate the Packet Error Rate of the communications link in less than ideal circumstances. To simplify the demo, default settings in the firmware are used. This procedure explains how to configure the board connected to the PC as the Receiver, how to configure the standalone board as the Transmitter, and how to send 200 packets from the Transmitter to the Receiver. Statistics are then provided showing the number of “error-free” packets received. From that the Packet Error Rate (PER) can be computed.

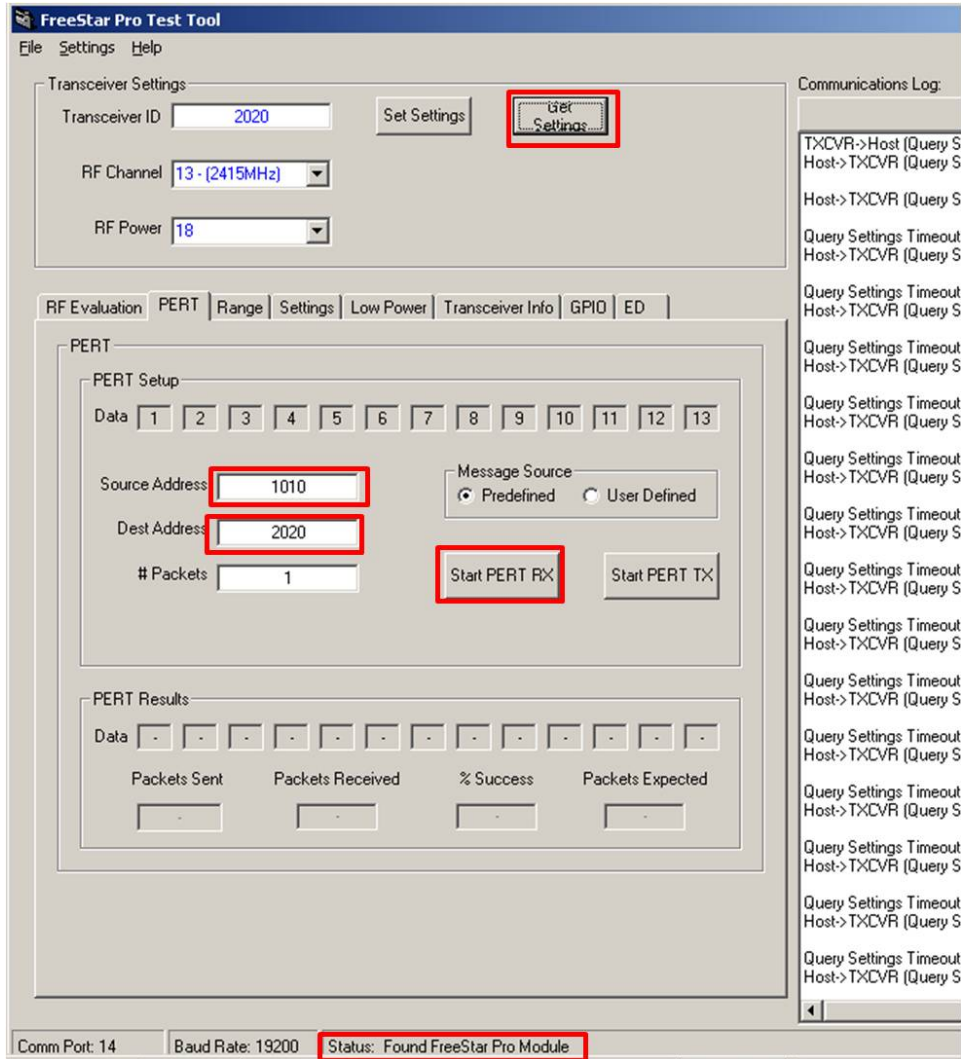

Figure 26 – Screen, Test Tool – PERT Demo

- 1) Connect one of the evaluation boards to the PC through a USB cable and power up the board.
- 2) Follow connection procedures given in Section 4.3.1 until the Status is '**Found FreeStar Pro Module**'
- 3) Push '**SWITCH 2**' on the evaluation board to configure the connected board as the Receiver.
- 4) In the '**Transceiver Settings**' window, click the '**Get Settings**' button to ensure the settings are:
 - o '**Transceiver ID**': '2020'
 - o '**RF Channel**': '13 – (2415MHz)'
 - o '**RF Power**': '06'

Note: The screenshot shows an SMAC configuration instead of a MAC configuration – See Section 6.1 for more information with regards to RF Power).

In the '**PERT Setup**' Section:

- 5) Ensure that '**Predefined**' is checked in the '**Message Source**' section.
- 6) Check that the '**Dest Address**' is '2020'.
- 7) Check that the '**Source Address**' is '1010'.
- 8) Click the '**Start PERT RX**' button to set up the Receiver. The Receiver Data should display the same

values in each of the fields as the Data in the Transmitter area. The four statistical fields should be zeros ('0').

- 9) Power up the Standalone board (using batteries supplied). (The standalone board may be separated from the Receiver to observe the PER results in different environments.)
- 10) Press '**SWITCH 4**' on the standalone board to configure it as the PERT Transmitter and start the packet transmissions.
 - o The ID of the transmitting board will be set to '**1010**'.
 - o The RF channel of the transmitting board will be set to Channel '**13**'.
 - o The RF power of the transmitting board will default to the maximum power, '**18**' (+20dbm).
 - o The transmitting board will transmit 200 PERT messages with the 'Predefined Message Source' as the 'Data' (in about 12 seconds). LED1 on the Transmitter board will blink once for each packet sent until all 200 packets have been transmitted.
- 11) On the Receiver evaluation board, LED 3 will be illuminate and LED 2 will blink until all 200 packets have been received.
- 12) Observe the results on the PC screen.
 - a. Each packet can be seen in the '**Communications Log**' as it is received.
 - b. In the PERT Results area, the '**Packets Expected**' field will immediately display '**200**'.
 - c. The '**Packets Sent**', '**Packets Received**', and '**% Success**' should start to increase in value as each packet is received.
 - d. When the transmitting board has completed transmission, the '**Packet Sent**' should equal the '**Packets Expected**'. '**Packets Received**' will be less than or equal to '**Packets Sent**' and '**% Success**' will reflect the ratio of '**Packets Received**' as a percentage of '**Packets Sent**'. This number can be used to calculate the Packet Error Rate (PER) for this demonstration using the formula:

$$PER = 100\% - \% \text{ Success'}$$

6 Using the GUI with the SMAC

6.1 RF Power

The MAC software from Freescale restricts the power settings from 0-6, as opposed to 0-18 for the SMAC. When the GUI identifies the transceiver as having the SMAC codebase the allowable power settings in the drop down menu is changed to a maximum of 18. See Figure 27.

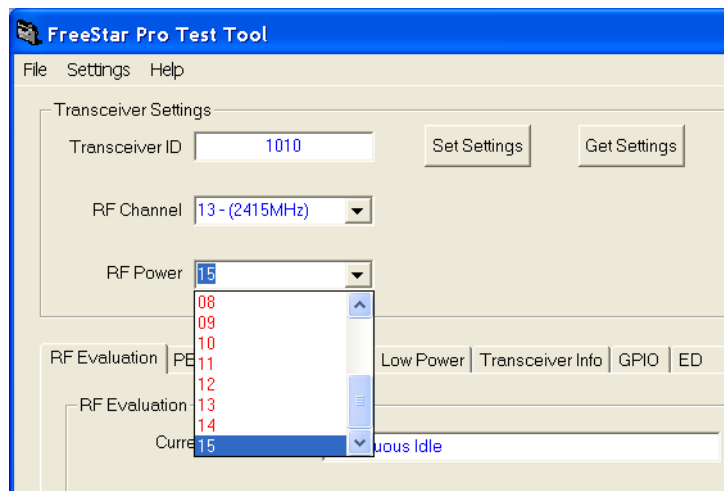

Figure 27 – RF Power with SMAC

6.2 Range Test

The SMAC software unlike the MAC does not handle ACK messages in the background. Thus it is possible to get a LQI message of an ACK message for transmitted messages, and this data is captured in the Transmitter section.

- **RX's LQI:** The Link Quality Indicator as measured by the receiver (with indicator "light").
- **RX'd ACK LQI:** The Link Quality Indicator of the acknowledgement messages as measured by the transmitter (with indicator "light").

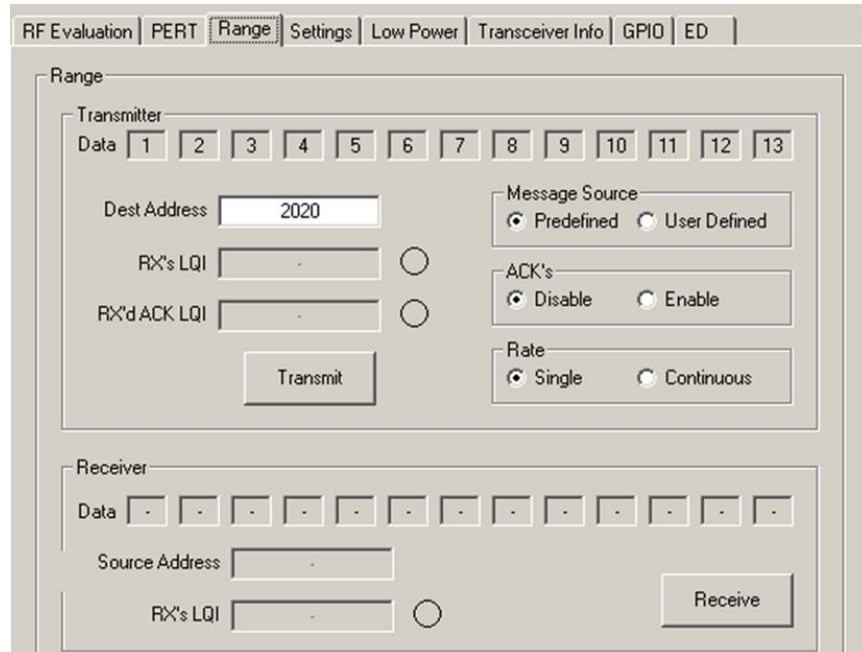

Figure 28 – Range test with SMAC.

6.3 Energy Scan

The SMAC software does not allow the duration of the energy scan to be selected. See Figure 29.

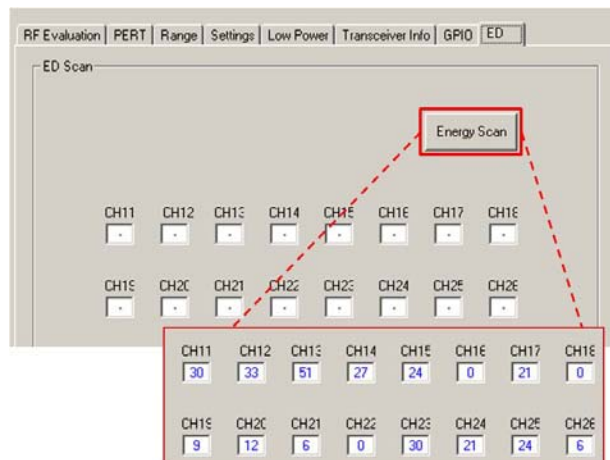

Figure 29 – Energy Scan with SMAC

7 DOWNLOADING TO FLASH THROUGH THE USB

In the event that the Application firmware on one of the evaluation boards needs to be reinstalled, this section describes a simple procedure for downloading to Flash memory using the **'MC1322x Firmware Loader'** tool in the **Freescale Test Tool** program (Version 11.1.0). Please refer to Freescale Semiconductors' **"Freescale Test Tool User's Guide"** (Freescale Doc # TTUG) for detailed information and explanations on this specific tool or for the rest of the program.

7.1 PREREQUISITE HARDWARE AND SOFTWARE

- One **ZFSM-201-EVB-1** FreeStar Pro Evaluation Board.
- The **Freescale Test Tool** program which is downloaded as a part of the **BeeKit™** download

For information on downloading this program refer to the Section on Installing **BeeKit™** in **"ZFSM-201-EVB-1 BeeKit Porting Guide"** (CEL Doc #0006-00-08-03-000)

7.2 ERASING FLASH MEMORY

This section describes a hardware procedure for erasing the Flash memory of the **ZFSM-201-1** Module. If using the **Freescale Test Tool** to upload firmware, the Flash memory must be erased prior to programming.

- 1) With power applied to the evaluation board, attach shorting jumpers to the **'FLASH Erase Jumpers'** **'J19'** and **'J20'**. See Figure 30 for their location (shown without jumpers).

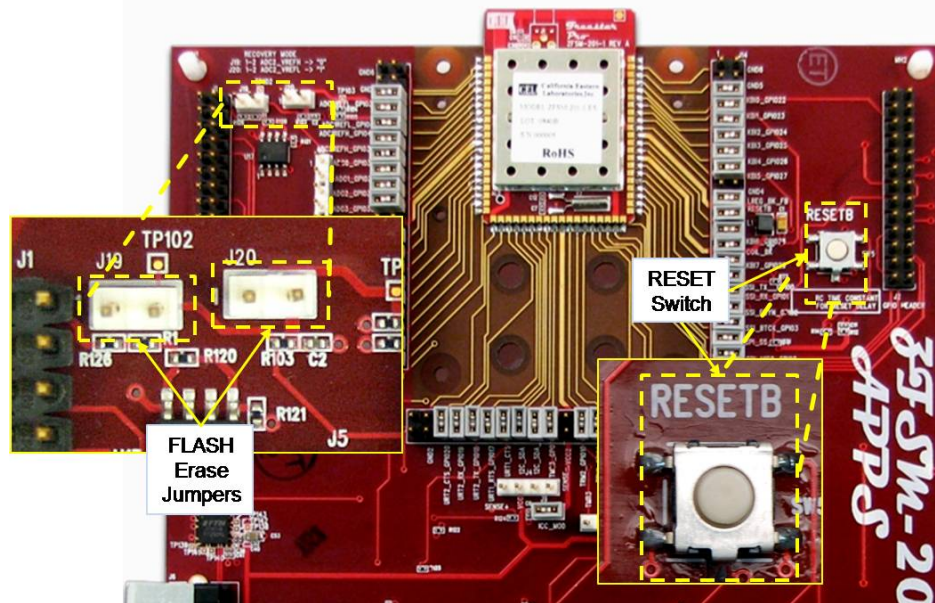

Figure 30 – Photo, EVB Details (FLASH Erase Jumpers & RESET)

- 2) Press the **'RESETB'** switch. See Figure 30 for its location.
- 3) LED 1, LED 2, and LED 3 should all be illuminated. The FLASH memory is now erased.
- 4) Remove the shorting jumpers.

7.3 DOWNLOADING NEW FLASH IMAGE

- 1) Connect the evaluation board (with FLASH memory erased) to the PC using a USB cable. Apply power to the board. LED's 1, 2, and 3 should be illuminated, indicating that the memory has been erased.

- 2) Open the **Freescal** **Test Tool** (FSTT) program by double-clicking the icon [] on the user's desktop. The screen in Figure 31 will appear:



Figure 31 – Screen, Freescal Test Tool – Opening

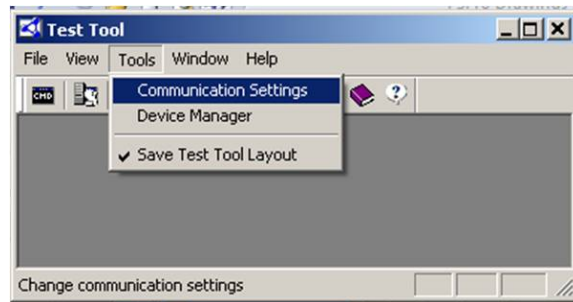

Figure 32 – Screen, FSTT – Communication Settings

- 3) Click on the **'Tools'** menu, and click on the **'Communication Settings'** in the Pop-up as shown in Figure 32. An empty version of the screen in Figure 33 should appear.
- 4) Click on **'Add Internal'**. The screen in Figure 34 will appear.

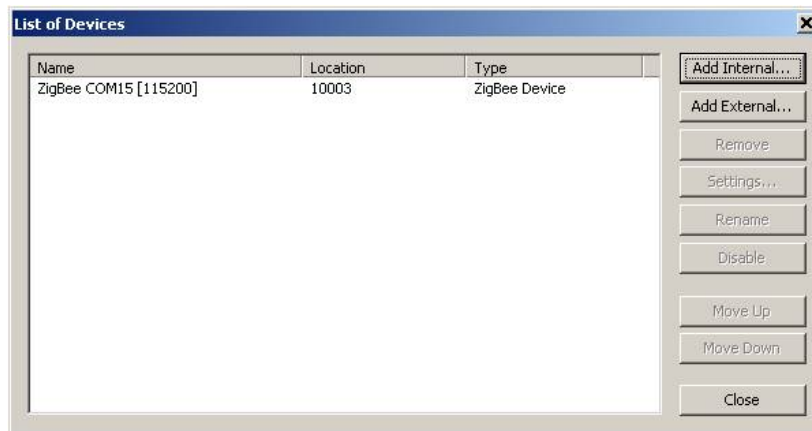

Figure 33 – Screen, FSTT – Comm List of Devices

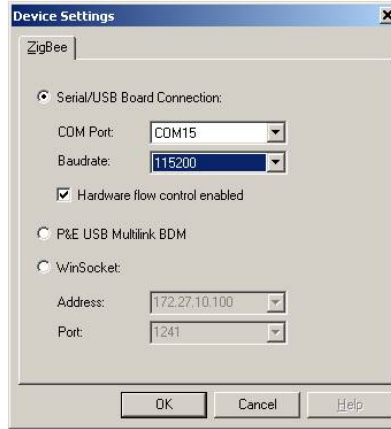

Figure 34 – Screen, FSTT – Comm Dev Setting

- 5) Choose the '**COM Port**' to which the evaluation board is connected, change the '**Baudrate**' to '**115200**' and click '**OK**'. The chosen evaluation board will be displayed on the screen as in Figure 33. Click '**Close**'.

If the '**COM Port**' needs to be determined, the **Test Tool** program has a convenient link to **Device Manager** to do so. Notice (in Figure 32) that '**Device Manager**' is just below '**Communication Settings**' in the '**Tools**' menu. Click on '**Device Manager**' and follow the procedure in Section 4.3.1.

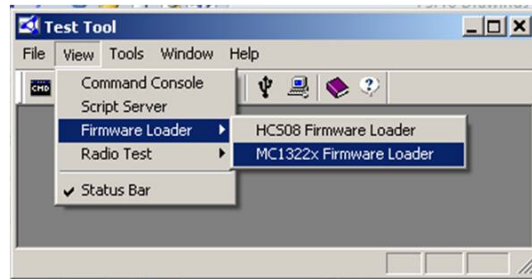

Figure 35 – Screen, FSTT – Firmware Loader

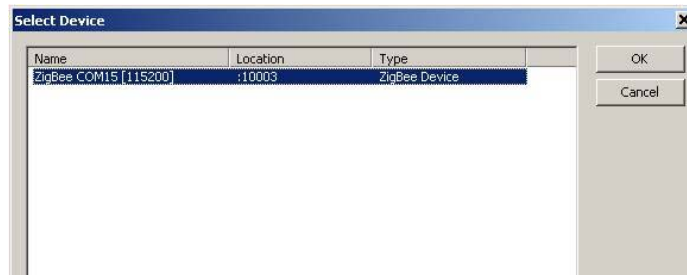

Figure 36 – Screen, FSTT – Device Selection

- 6) As shown in Figure 35, click on the '**View**' menu, click on the '**Firmware Loader**' and '**MC1322x Firmware Loader**' in the Pop-ups. The screen in Figure 36 will appear. Select the device (defined in Figure 33) and click '**OK**'. The screen in Figure 37 will be displayed.

Note: the '**Erase flash before programming**' option **DOES NOT WORK**. The Flash memory must already be erased (using the procedure in Section 7.2) in order to successfully perform an upload to Flash.

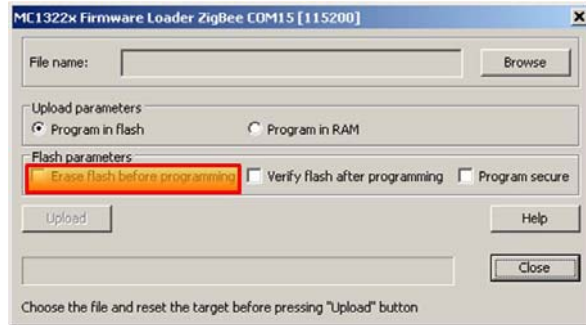

Figure 37 – Screen, FSTT – Firmware Loader Opening

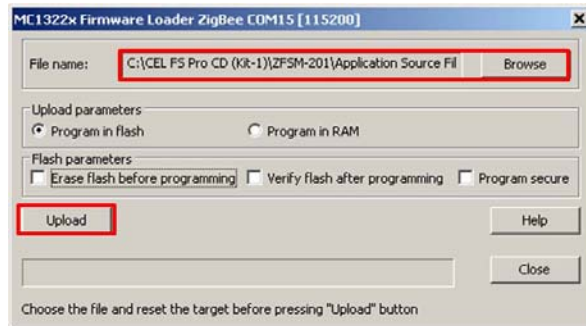



Figure 38 – Screen, FSTT – Selecting the binary File

- 7) Click the **'Browse'** button and find the binary (.bin) file to load. The .bin file that was originally loaded on the device is located on the CEL CD in the directory \ZF5M-201\Application Source Files\CEL_MAC_111_v1.3\CEL_MAC_111\Debug\Exe\ and is named CEL_MAC_111.bin. See Figure 38.
 - o Alternatively, if it is desired to use the SMAC variant of the sample application, the .bin file may be located on the CD in the directory \ZF5M-201\Application Source Files\CEL_SMAC_111_v1.2\CEL_SMAC_111\Debug\Exe\ and is named CEL_SMAC_111.bin.
- 8) In the Upload parameters section, select **'Program in flash'**.
- 9) Press the **'RESETB'** switch on the evaluation board; hold for a few seconds.
- 10) Click the **'Upload'** button in Figure 38.



- 11) If unsuccessful, the screen  will be displayed. Repeat step 9) and 10). (These steps may need to be repeated a few times.)
- 12) While the upload is occurring, the screen in Figure 39 will be displayed.

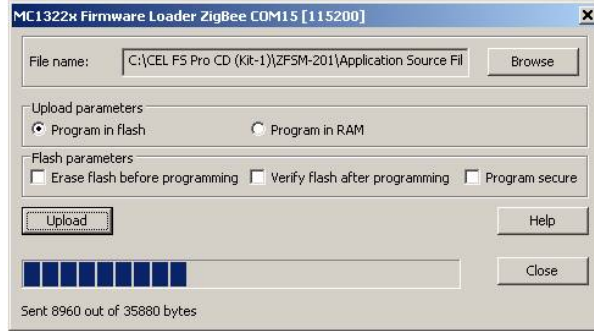

Figure 39 – Screen, FSTT – Upload in Process

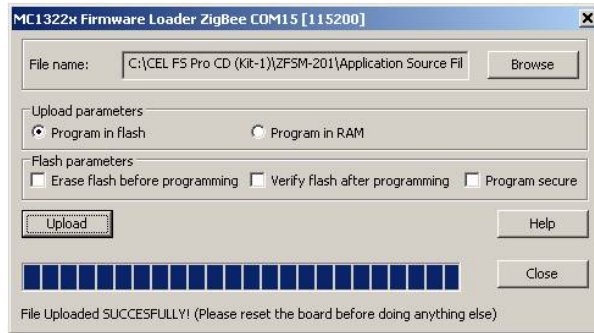

Figure 40 – Screen, FSTT – Upload Complete)

- 13) When it is complete, the screen in Figure 40 will be displayed.
- 14) Press the '**RESETB**' switch on the evaluation board. All four LED's should light and go out in sequence. The firmware has been successfully uploaded to the device.

8 REVISION HISTORY

<u>Revision</u>	<u>Date</u>	<u>Description</u>
PRELIMINARY	28Oct08	Released
A	04Feb09	Added MAC Support
B	22May09	Updated for MAC v1.11 and MAC-based demo as pre-loaded firmware.

APPENDIX 1: USING AN EXTERNAL ANTENNA

Note: Use of an antenna which has not been certified by FCC, IC or CE type acceptance is not permitted. Please refer to ZFSM-201-1 datasheet for the latest RF certification information.

The **ZFSM-201-1** module is available as a **ZFSM-201-1C** with an MMCX connector for an external antenna.

Alternatively, a module can be modified to incorporate an  MMCX Right Angle Jack connector to the board (though for the customer to do so, will void the warranty). This simple procedure is given on how to modify the board for the inclusion of an external antenna connector.

Table 8 – Components Required and Optional

Qty	Vendor	Part Number	Description
1	Amphenol	908-NM24100	MMCX Right Angle Jack PCB Mount (required)
	Johanson	135-3701-301	
	Molex	073415-1001	
1	Any		0402 SIZE SMT CERAMIC CAPACITOR, 100pF (replacement if needed)
-	Amphenol	908-31100	MMCX Plug to SMA Jack Adaptor (optional for antennas with SMA plug connectors)

- 1) Acquire a MMCX Right Angle Jack, PCB Mount connector from any of the three vendors listed (or equivalent).
- 2) Change the position of the capacitor as shown in Figure 41 (or replace with new).
- 3) Attach the connector to the module and solder in place.

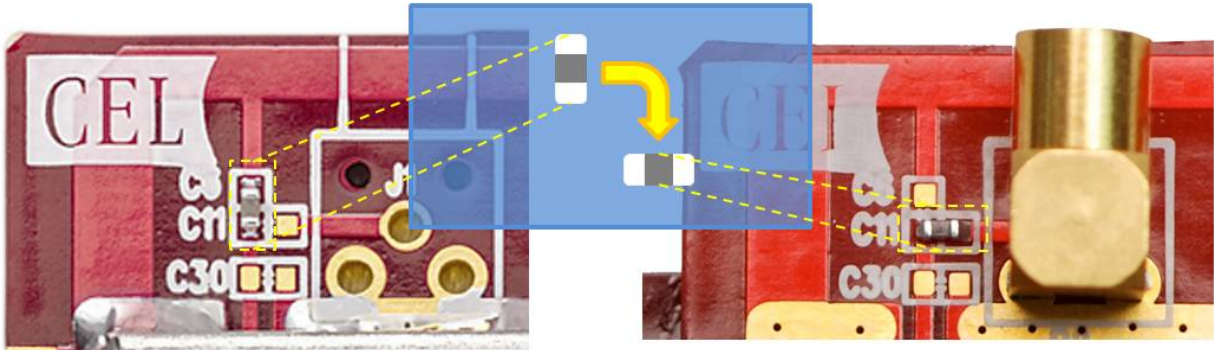

Figure 41 – Diagram, External Antenna Capacitor Change

The PCB Trace antenna will no longer be connected and the MMCX Jack connector will be active.

APPENDIX 2: LICENSING ARRANGEMENTS

Information in this document is provided solely to enable system and software implementers to use California Eastern Laboratories (CEL) products. There are no express or implied copyright licenses granted hereunder to design or fabricate any integrated circuits or integrated circuits based on the information in this document.

California Eastern Laboratories reserves the right to make changes without further notice to any products herein. CEL makes no warranty, representation or guarantee regarding the suitability of its products for any particular purpose, nor does CEL assume any liability arising out of the application or use of any product or circuit, and specifically disclaims any and all liability, including without limitation consequential or incidental damages. "Typical" parameters that may be provided in CEL data sheets and/or specifications can and do vary in different applications and actual performance may vary over time. All operating parameters, including "Typicals", must be validated for each customer application by customer's technical experts. CEL does not convey any license under its patent rights nor the rights of others. CEL products are not designed, intended, or authorized for use as components in systems intended for surgical implant into the body, or other applications intended to support or sustain life, or for any other application in which the failure of the CEL product could create a situation where personal injury or death may occur. Should Buyer purchase or use CEL products for any such unintended or unauthorized application, Buyer shall indemnify and hold California Eastern Laboratories and its officers, employees, subsidiaries, affiliates, and distributors harmless against all claims, costs, damages, and expenses, and reasonable attorney fees arising out of, directly or indirectly, any claim of personal injury or death associated with such unintended or unauthorized use, even if such claim alleges that CEL was negligent regarding the design or manufacture of the part.

BeeKit, Freescale and the Freescale logo are trademarks or registered trademarks of Freescale Semiconductor, Inc.. ARM and ARM7 are the trademarks or registered trademarks of ARM Limited. IAR, IAR Systems, IAR Embedded Workbench are the trademarks or registered trademarks of IAR Systems AB. All other product or service names are the property of their respective owners.

California Eastern Laboratories, Inc. 2008