



BIPOLAR ANALOG INTEGRATED CIRCUIT

μ PC8233TK

SiGe:C LOW NOISE AMPLIFIER FOR GPS/MOBILE COMMUNICATIONS

DESCRIPTION

The μ PC8233TK is a silicon germanium carbon (SiGe:C) monolithic integrated circuit designed as low noise amplifier for GPS and mobile communications. This device exhibits low noise figure and high power gain characteristics. This device is enabled in the frequency range from 1.5 to 2.4 GHz by modifying the external matching circuit.

This device is suitable for the reduction in power consumption of the mobile communication system because it operates by low voltage and low current.

The package is 6-pin lead-less minimold, suitable for surface mount.

This IC is manufactured using our UHS4 (Ultra High Speed Process) SiGe:C bipolar process.

FEATURES

- Supply voltage : $V_{CC} = 1.6$ to 3.3 V (2.7 V TYP.)
- Low noise : NF = 0.90 dB TYP. @ $V_{CC} = 2.7$ V, $f_{in} = 1.575$ MHz
NF = 0.90 dB TYP. @ $V_{CC} = 1.8$ V, $f_{in} = 1.575$ MHz
- High gain : GP = 20 dB TYP. @ $V_{CC} = 2.7$ V, $f_{in} = 1.575$ MHz
GP = 19.5 dB TYP. @ $V_{CC} = 1.8$ V, $f_{in} = 1.575$ MHz
- Low current consumption : $I_{CC} = 3.5$ mA TYP. @ $V_{CC} = 2.7$ V
- Built-in power-saving function : $V_{Pson} = 1.0$ V to V_{CC} , $V_{Psoff} = 0.0$ to 0.4 V
- High-density surface mounting : 6-pin lead-less minimold package ($1.5 \times 1.1 \times 0.55$ mm)
- Included very robust bandgap regulator (Small V_{CC} and T_A dependence)
- Included protection circuits for ESD

APPLICATION

- Low noise amplifier for GPS and mobile communications

ORDERING INFORMATION

Part Number	Order Number	Package	Marking	Supplying Form
μ PC8233TK-E2	μ PC8233TK-E2-A	6-pin lead-less minimold (1511 PKG) (Pb-Free)	6P	<ul style="list-style-type: none">• 8 mm wide embossed taping• Pin 1, 6 face the perforation side of the tape• Qty 5 kpcs/reel

Remark To order evaluation samples, contact your nearby sales office.

Part number for sample order: μ PC8233TK-A

Caution: Observe precautions when handling because these devices are sensitive to electrostatic discharge

The information in this document is subject to change without notice. Before using this document, please confirm that this is the latest version.

PIN CONNECTIONS

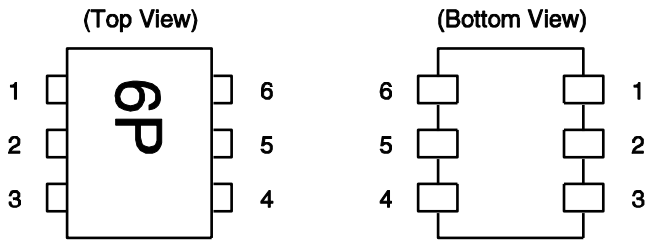

Pin No.	Pin Name
1	INPUT
2	GND
3	Power Save
4	OUTPUT
5	GND
6	V _{cc}

INTERNAL BLOCK DIAGRAM

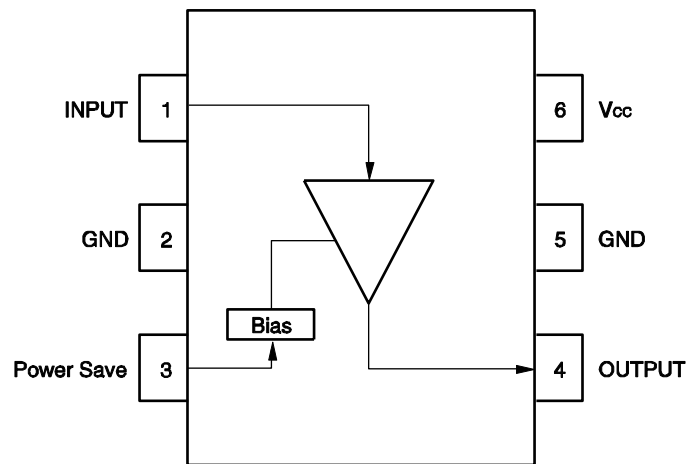

ABSOLUTE MAXIMUM RATINGS

Parameter	Symbol	Test Conditions	Ratings	Unit
Supply Voltage	V _{cc}	T _A = +25°C	4.0	V
Power-Saving Voltage	V _{PS}	T _A = +25°C	4.0	V
Power Dissipation	P _D	T _A = +85°C Note	232	mW
Operating Ambient Temperature	T _A		-40 to +85	°C
Storage Temperature	T _{stg}		-55 to +150	°C
Input Power	P _{in}		+10	dBm

Note Mounted on double-side copper-clad 50 × 50 × 1.6 mm epoxy glass PWB

RECOMMENDED OPERATING RANGE

Parameter	Symbol	MIN.	TYP.	MAX.	Unit
Supply Voltage	V _{cc}	1.6	2.7	3.3	V
Operating Ambient Temperature	T _A	-40	+25	+85	°C
Power Save Turn-on Voltage	V _{PSon}	1.0	-	V _{cc}	V
Power Save Turn-off Voltage	V _{PSoff}	0	-	0.4	V

ELECTRICAL CHARACTERISTICS

($T_A = +25^\circ\text{C}$, $V_{CC} = V_{PS} = 2.7\text{ V}$, $f_{in} = 1\ 575\text{ MHz}$, unless otherwise specified)

Parameter	Symbol	Test Conditions	MIN.	TYP.	MAX.	Unit
Circuit Current	I _{CC}	No Signal ($V_{PS} = 2.7\text{ V}$)	2.5	3.5	4.8	mA
		At Power-Saving Mode ($V_{PS} = 0\text{ V}$)	–	–	1	μA
Power Gain	G _P	$P_{in} = -35\text{ dBm}$	17.5	20.0	22.5	dB
Noise Figure	NF		–	0.9	1.2	dB
Input Return Loss	RL _{in}		7	10	–	dB
Output Return Loss	RL _{out}		10	16	–	dB

STANDARD CHARACTERISTICS FOR REFERENCE 1

($T_A = +25^\circ\text{C}$, $V_{CC} = V_{PS} = 2.7\text{ V}$, $f_{in} = 1\ 575\text{ MHz}$, unless otherwise specified)

Parameter	Symbol	Test Conditions	Reference	Unit
Input 3rd Order Intercept Point	IIP ₃	$f_{in1} = 1\ 575\text{ MHz}$, $f_{in2} = 1\ 574\text{ MHz}$	–8.5	dBm
Isolation	ISL		36	dB
Gain 1 dB Compression Input Power	$P_{in(1\text{ dB})}$		–23	dBm

STANDARD CHARACTERISTICS FOR REFERENCE 2

($T_A = +25^\circ\text{C}$, $V_{CC} = V_{PS} = 1.8\text{ V}$, $f_{in} = 1\ 575\text{ MHz}$, unless otherwise specified)

Parameter	Symbol	Test Conditions	Reference	Unit
Circuit Current	I _{CC}	No Signal ($V_{PS} = 1.8\text{ V}$)	3.3	mA
Power Gain	G _P	$P_{in} = -35\text{ dBm}$	19.5	dB
Noise Figure	NF		0.9	dB
Input 3rd Order Intercept Point	IIP ₃	$f_{in1} = 1\ 575\text{ MHz}$, $f_{in2} = 1\ 574\text{ MHz}$	–9.5	dBm
Input Return Loss	RL _{in}		9.5	dB
Output Return Loss	RL _{out}		15.5	dB
Isolation	ISL		36	dB
Gain 1 dB Compression Input Power	$P_{in(1\text{ dB})}$		–23.5	dBm

TEST CIRCUIT

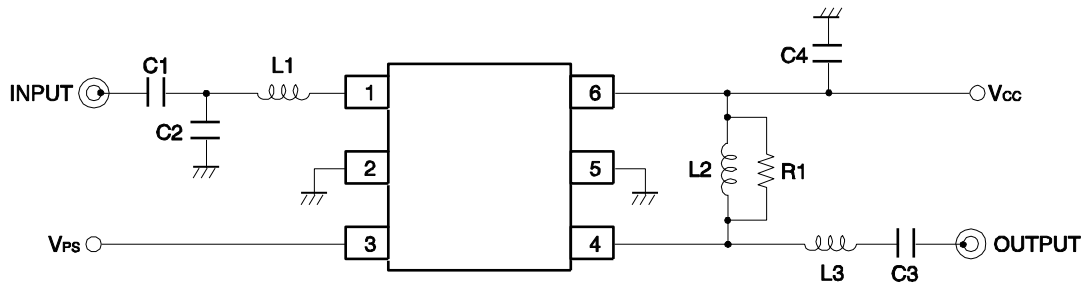

COMPONENT LIST

Symbol	Type	Value	Unit
C1	Chip Capacitor	1 000	pF
C2	Chip Capacitor	1.2	pF
C3	Chip Capacitor	18	pF
C4	Chip Capacitor	1 000	pF
L1	Chip Inductor	8.2	nH
L2	Chip Inductor	18	nH
L3	Chip Inductor	6.8	nH
R1	Chip Resistor	360	Ω

TYPICAL CHARACTERISTICS ($T_A = +25^\circ\text{C}$, unless otherwise specified)

CIRCUIT CURRENT vs. SUPPLY VOLTAGE

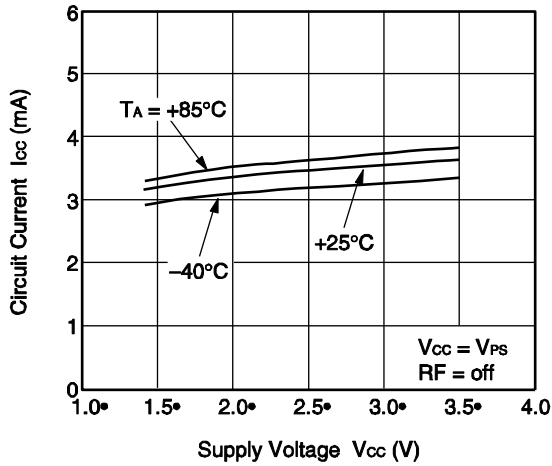

CIRCUIT CURRENT vs. POWER-SAVING VOLTAGE

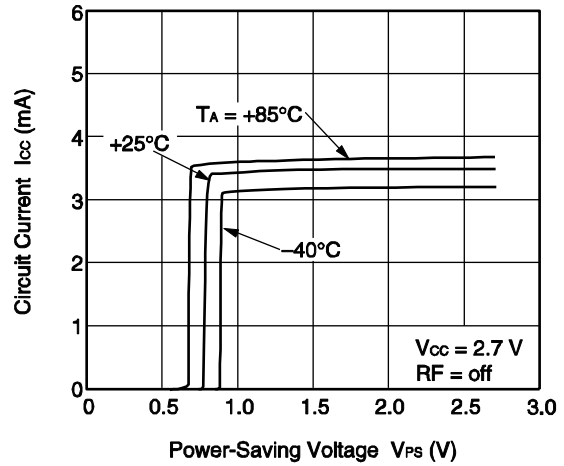

CIRCUIT CURRENT vs. POWER-SAVING VOLTAGE

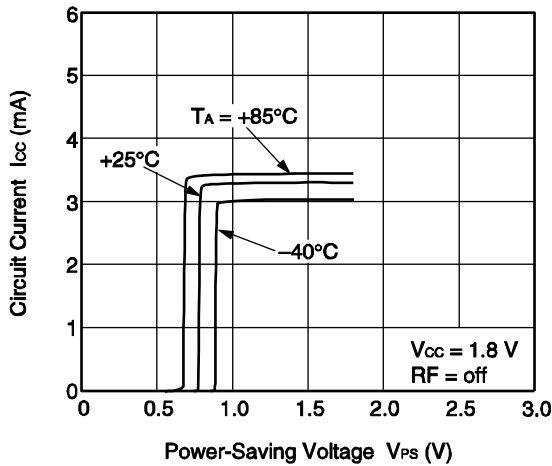

CIRCUIT CURRENT vs. OPERATING AMBIENT TEMPERATURE

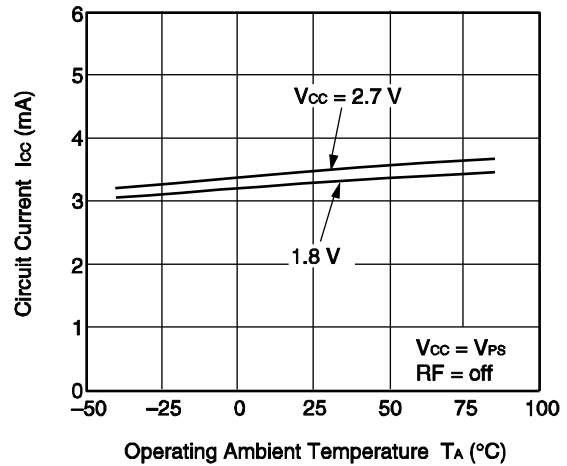

POWER GAIN vs. FREQUENCY

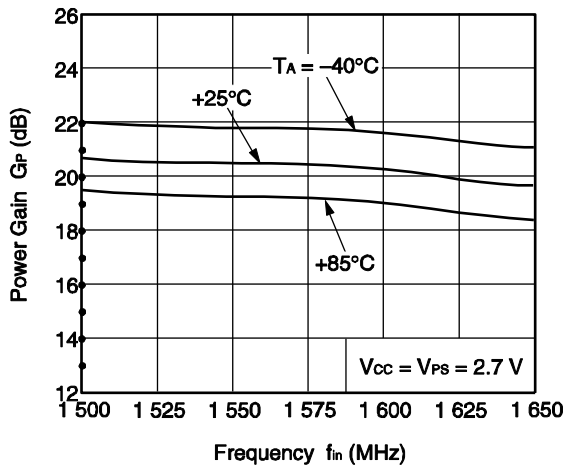

NOISE FIGURE vs. FREQUENCY

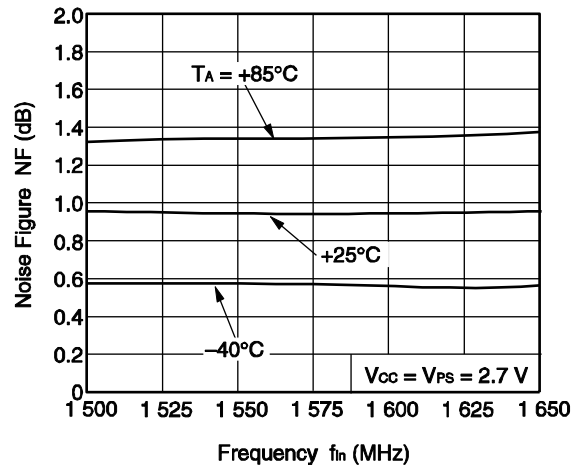

Remark The graphs indicate nominal characteristics.

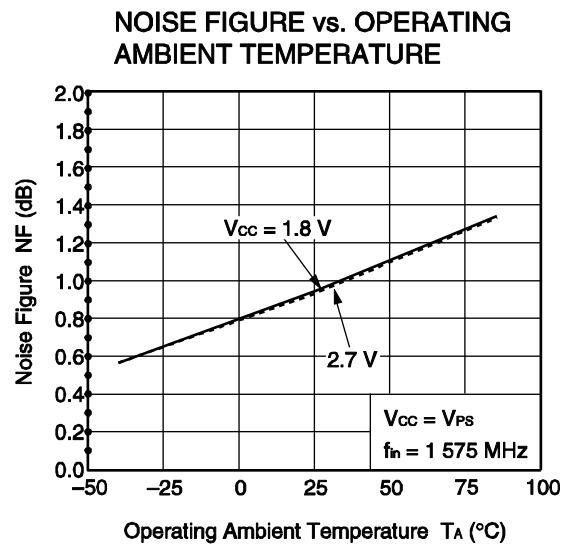
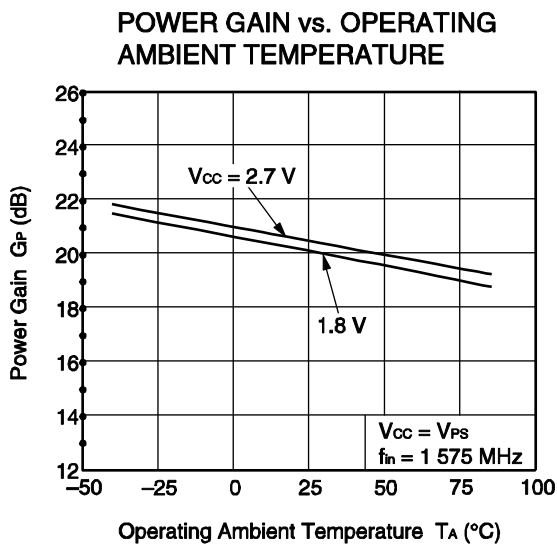
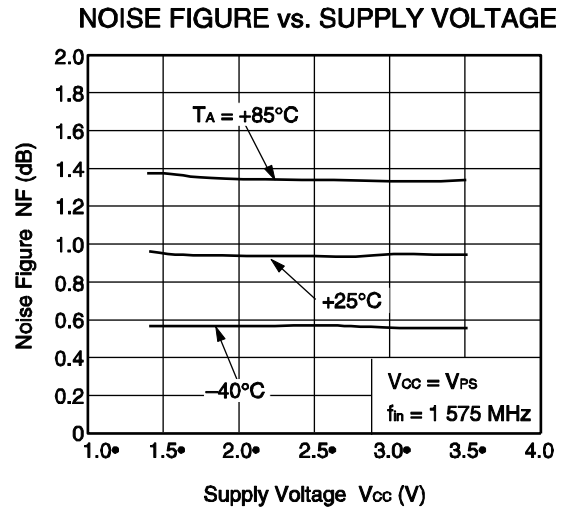
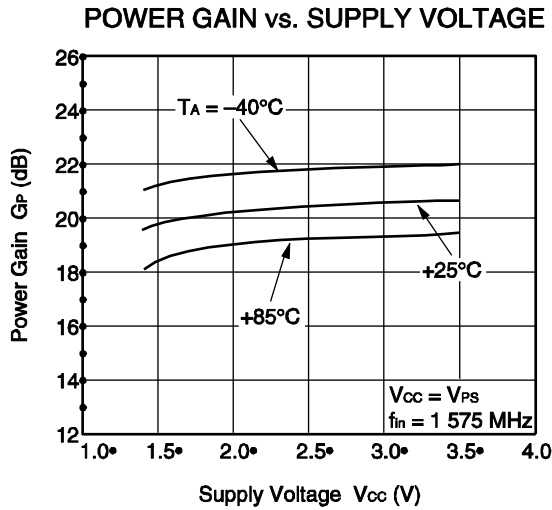
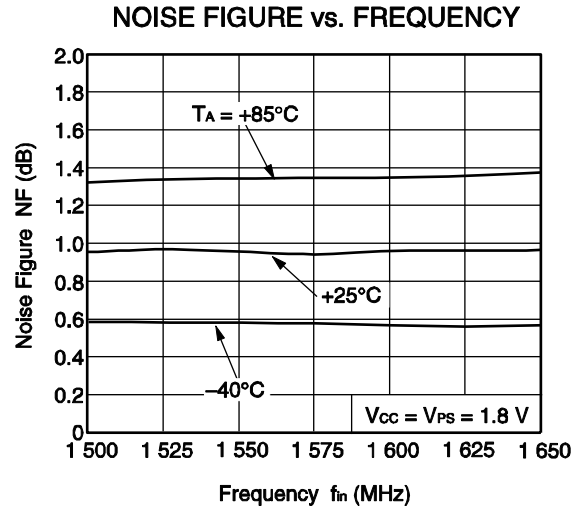
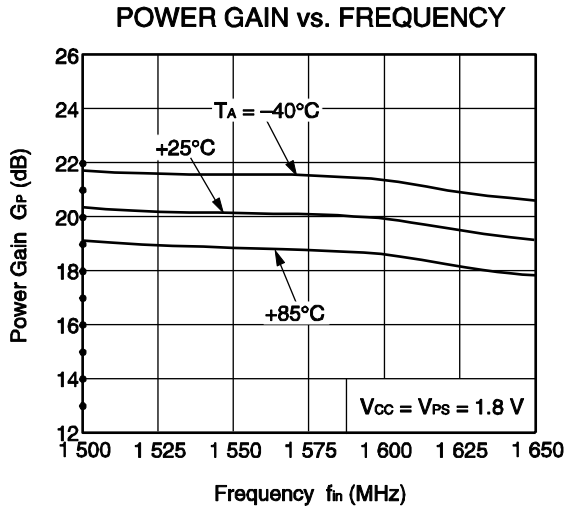

Remark The graphs indicate nominal characteristics.

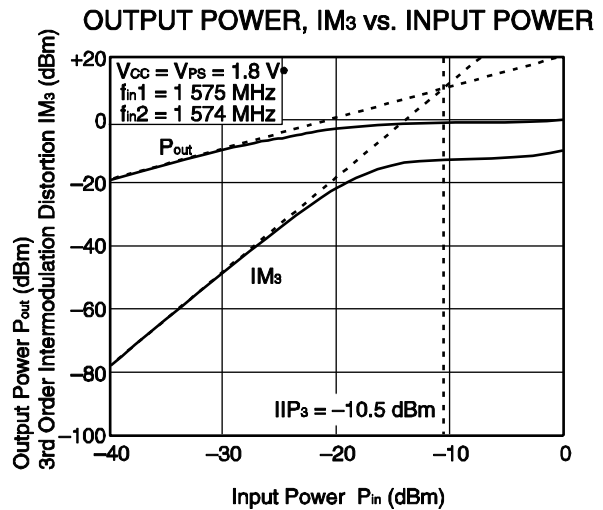
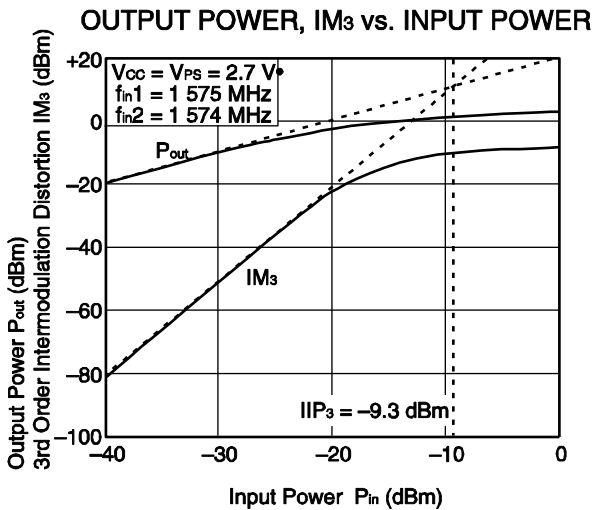
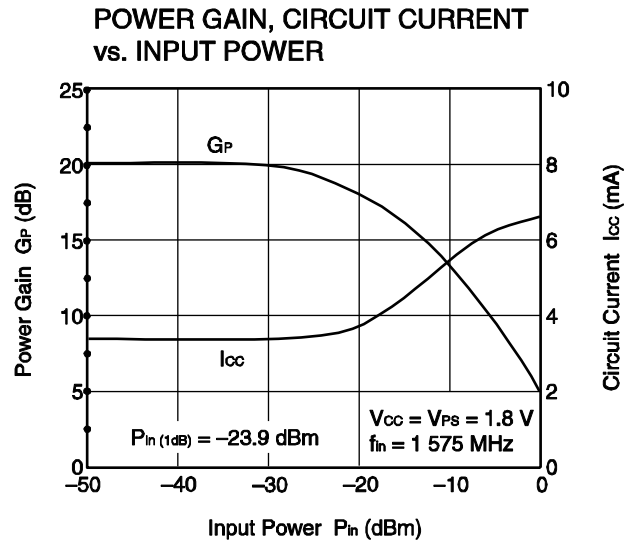
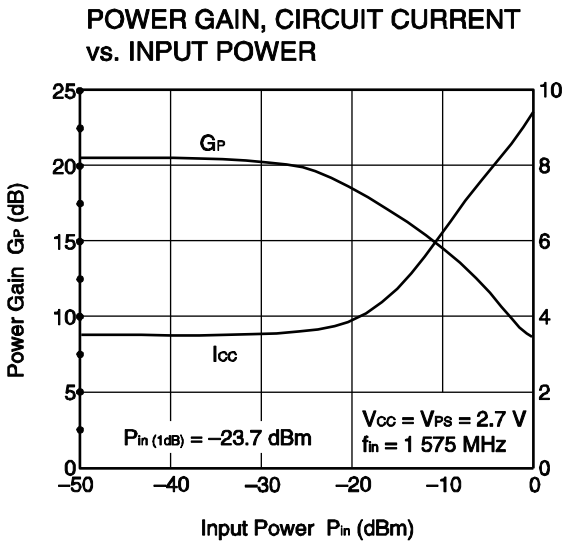
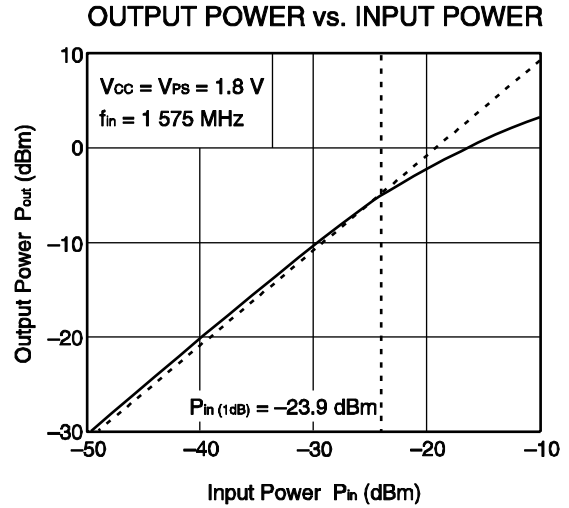
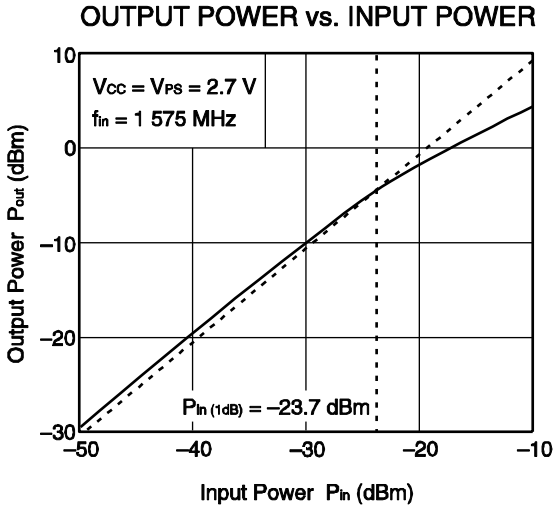

Remark The graphs indicate nominal characteristics.

GAIN 1 dB COMPRESSION INPUT POWER vs. OPERATING AMBIENT TEMPERATURE

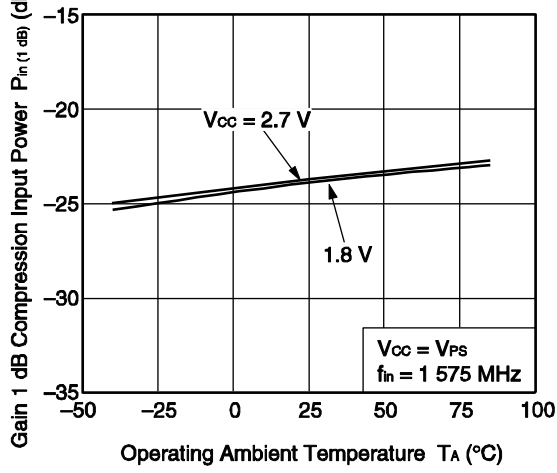

IIP₃, OIP₃ vs. OPERATING AMBIENT TEMPERATURE

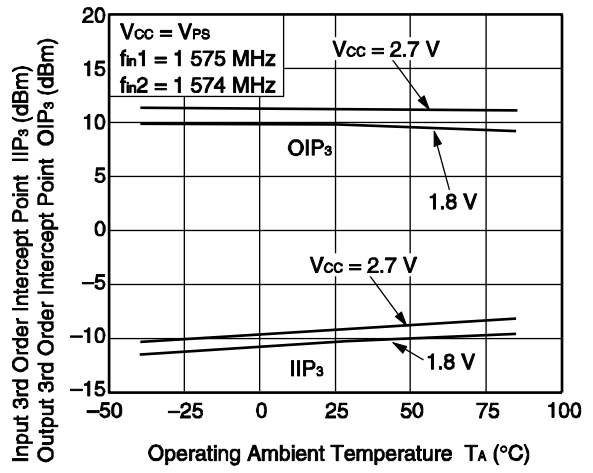

K FACTOR vs. FREQUENCY

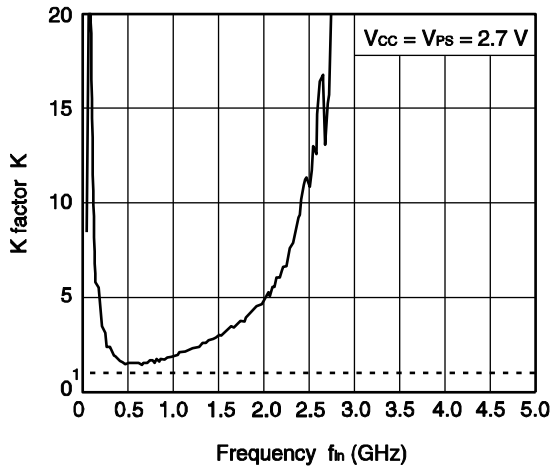

K FACTOR vs. FREQUENCY

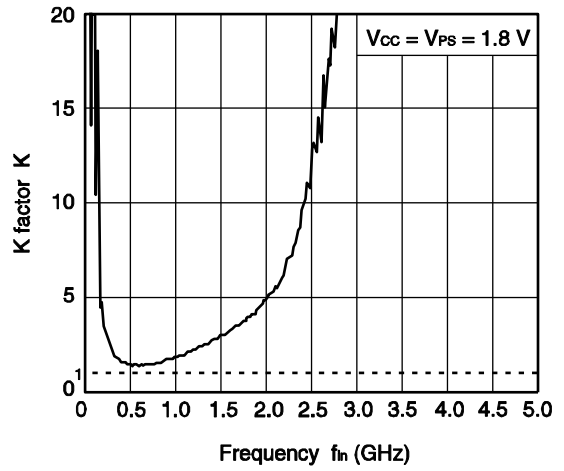

Remark The graphs indicate nominal characteristics.

S-PARAMETERS ($T_A = +25^\circ\text{C}$, $V_{CC} = V_{PS} = 2.7\text{ V}$, monitored at connector on board)

S₁₁-FREQUENCY

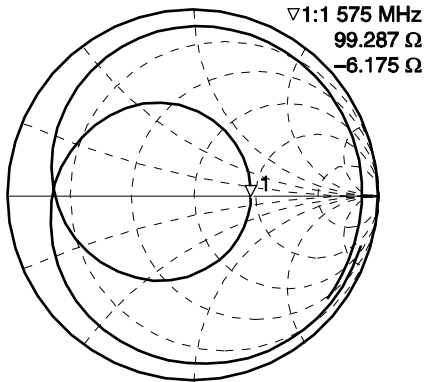

START 100.000 000 MHz STOP 4 100.000 000 MHz

S₂₂-FREQUENCY

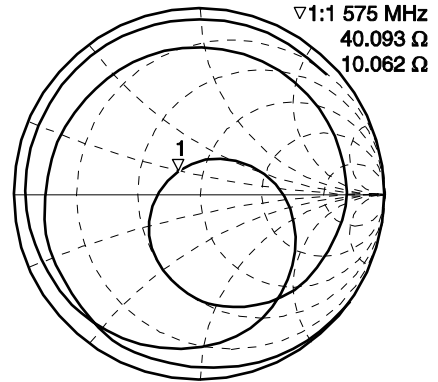

START 100.000 000 MHz STOP 4 100.000 000 MHz

INPUT RETURN LOSS vs. FREQUENCY

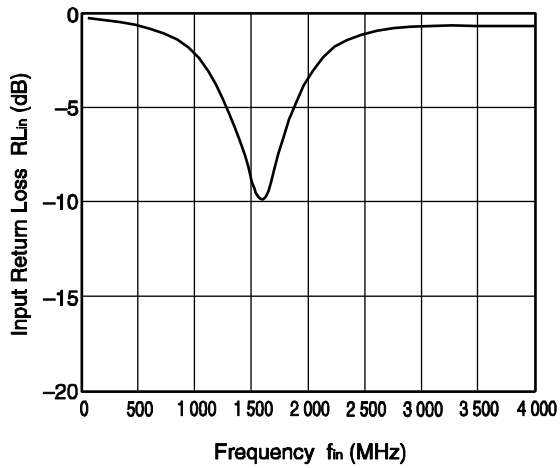

OUTPUT RETURN LOSS vs. FREQUENCY

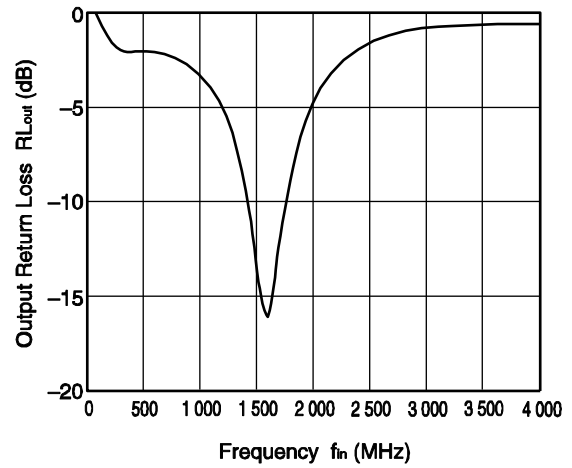

POWER GAIN vs. FREQUENCY

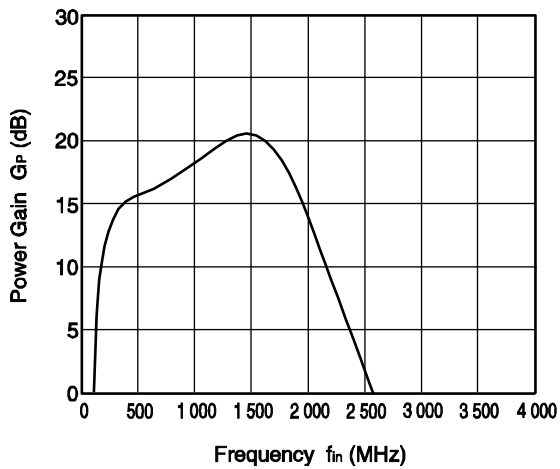

ISOLATION vs. FREQUENCY

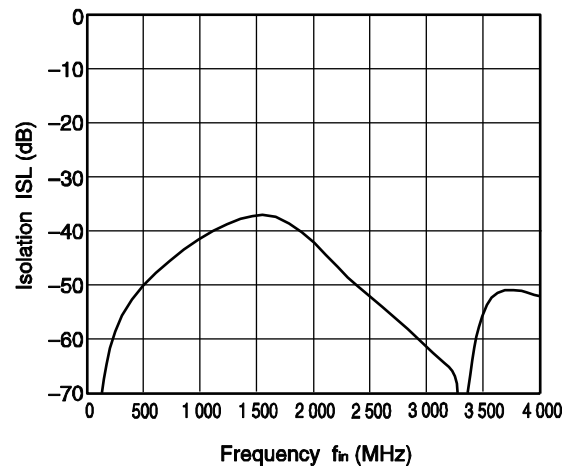

Remark The graphs indicate nominal characteristics.

S-PARAMETERS ($T_A = +25^\circ\text{C}$, $V_{CC} = V_{PS} = 1.8\text{ V}$, monitored at connector on board)

S₁₁-FREQUENCY

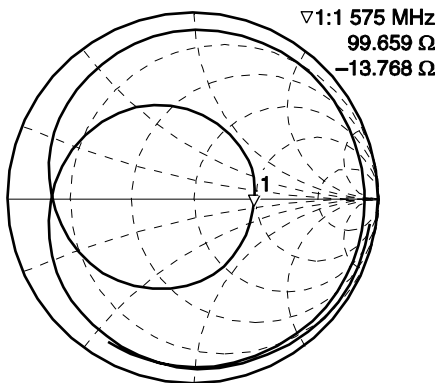

START 100.000 000 MHz STOP 4 100.000 000 MHz

S₂₂-FREQUENCY

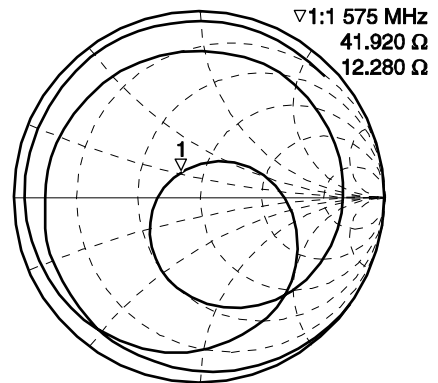

START 100.000 000 MHz STOP 4 100.000 000 MHz

INPUT RETURN LOSS vs. FREQUENCY

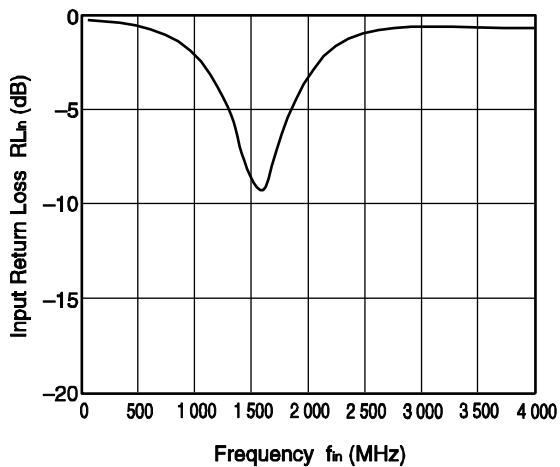

OUTPUT RETURN LOSS vs. FREQUENCY

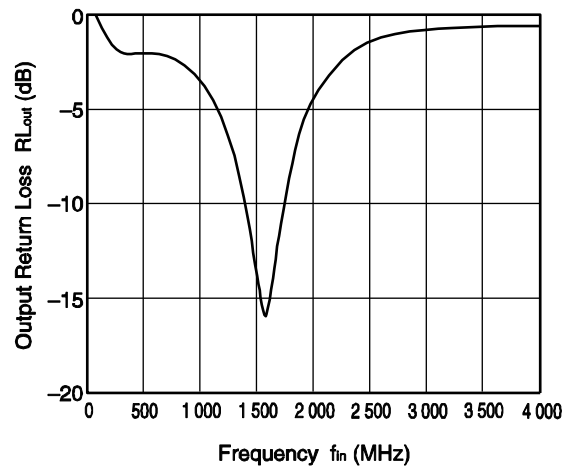

POWER GAIN vs. FREQUENCY

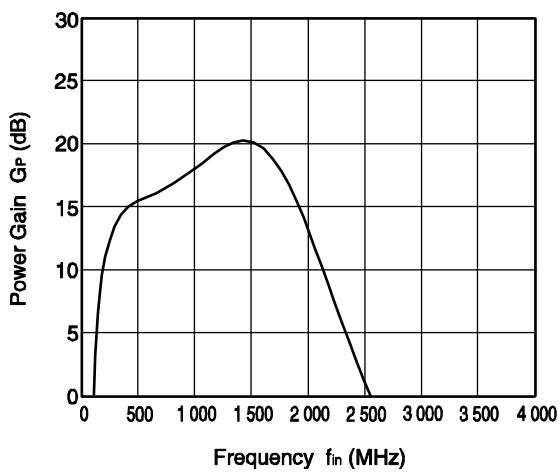

ISOLATION vs. FREQUENCY

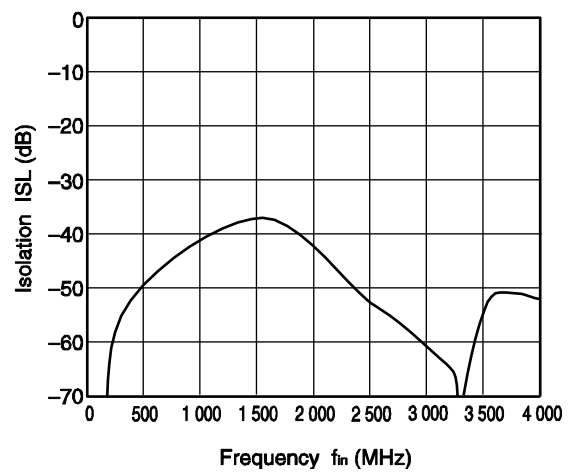

Remark The graphs indicate nominal characteristics.

PACKAGE DIMENSIONS

6-PIN LEAD-LESS MINIMOLD (1511 PKG) (UNIT: mm)

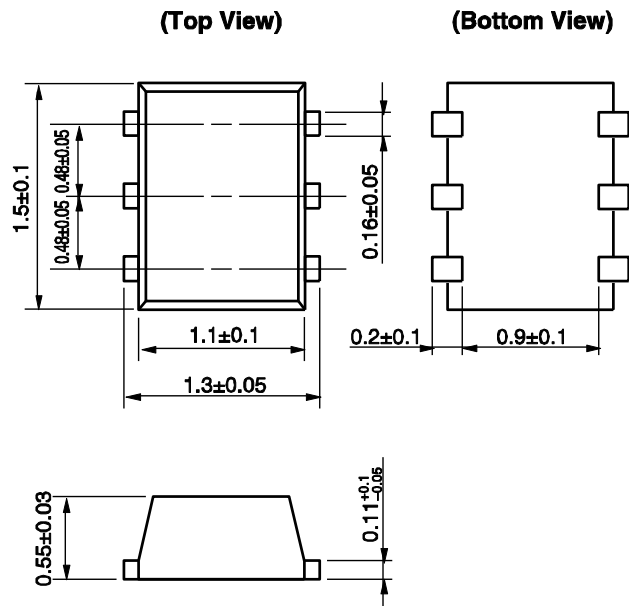

NOTES ON CORRECT USE

- (1) Observe precautions for handling because of electro-static sensitive devices.
- (2) Form a ground pattern as widely as possible to minimize ground impedance (to prevent undesired oscillation).
All the ground terminals must be connected together with wide ground pattern to decrease impedance difference.
- (3) The bypass capacitor should be attached to Vcc line.
- (4) Do not supply DC voltage to INPUT pin.

RECOMMENDED SOLDERING CONDITIONS

This product should be soldered and mounted under the following recommended conditions. For soldering methods and conditions other than those recommended below, contact your nearby sales office.

Soldering Method	Soldering Conditions	Condition Symbol
Infrared Reflow	Peak temperature (package surface temperature) : 260°C or below Time at peak temperature : 10 seconds or less Time at temperature of 220°C or higher : 60 seconds or less Preheating time at 120 to 180°C : 120±30 seconds Maximum number of reflow processes : 3 times Maximum chlorine content of rosin flux (% mass) : 0.2%(Wt.) or below	IR260
Wave Soldering	Peak temperature (molten solder temperature) : 260°C or below Time at peak temperature : 10 seconds or less Preheating temperature (package surface temperature) : 120°C or below Maximum number of flow processes : 1 time Maximum chlorine content of rosin flux (% mass) : 0.2%(Wt.) or below	WS260
Partial Heating	Peak temperature (terminal temperature) : 350°C or below Soldering time (per side of device) : 3 seconds or less Maximum chlorine content of rosin flux (% mass) : 0.2%(Wt.) or below	HS350

Caution Do not use different soldering methods together (except for partial heating).