

## L, S-BAND SPDT SWITCH

### DESCRIPTION

The  $\mu$ PG2015TB is a GaAs MMIC for L, S-band SPDT (Single Pole Double Throw) switch which were developed for mobile phone and another L, S-band application.

This device can operate frequency from 0.5 GHz to 2.5 GHz, having the low insertion loss and high isolation.

This device is housed in a 6-pin super minimold package. And this package is able to high-density surface mounting.

### FEATURES

- Supply voltage :  $V_{DD} = 2.7$  to  $3.0$  V (2.8 V TYP.)
- Switch control voltage :  $V_{cont(H)} = 2.7$  to  $3.0$  V (2.8 V TYP.)  
:  $V_{cont(L)} = -0.2$  to  $+0.2$  V (0 V TYP.)
- Low insertion loss :  $L_{INS1} = 0.25$  dB TYP. @  $f = 0.5$  to  $1.0$  GHz,  $V_{DD} = 2.8$  V,  $V_{cont} = 2.8$  V/0 V  
:  $L_{INS2} = 0.30$  dB TYP. @  $f = 1.0$  to  $2.0$  GHz,  $V_{DD} = 2.8$  V,  $V_{cont} = 2.8$  V/0 V  
:  $L_{INS3} = 0.35$  dB TYP. @  $f = 2.5$  GHz,  $V_{DD} = 2.8$  V,  $V_{cont} = 2.8$  V/0 V
- High isolation :  $ISL_1 = 27$  dB TYP. @  $f = 0.5$  to  $2.0$  GHz,  $V_{DD} = 2.8$  V,  $V_{cont} = 2.8$  V/0 V  
:  $ISL_2 = 24$  dB TYP. @  $f = 2.5$  GHz,  $V_{DD} = 2.8$  V,  $V_{cont} = 2.8$  V/0 V
- Middle power :  $P_{in(0.1\text{ dB})} = +27.0$  dBm TYP. @  $f = 2.5$  GHz,  $V_{DD} = 2.8$  V,  $V_{cont} = 2.8$  V/0 V
- High-density surface mounting : 6-pin super minimold package ( $2.0 \times 1.25 \times 0.9$  mm)

### APPLICATIONS

- L-band digital cellular or cordless telephone
- PCS, W-LAN, WLL and Bluetooth™ etc.

### ORDERING INFORMATION

Part Number	Package	Marking	Supplying Form
$\mu$ PG2015TB-E3	6-pin super minimold	G3J	<ul style="list-style-type: none"> <li>• Embossed tape 8 mm wide</li> <li>• Pin 1, 2, 3 face the perforation side of the tape</li> <li>• Qty 3 kpcs/reel</li> </ul>

**Remark** To order evaluation samples, contact your nearby sales office.

Part number for sample order:  $\mu$ PG2015TB-A

**Caution: Observe precautions when handling because these devices are sensitive to electrostatic discharge**

The information in this document is subject to change without notice. Before using this document, please confirm that this is the latest version.

**PIN CONNECTIONS AND INTERNAL BLOCK DIAGRAM**

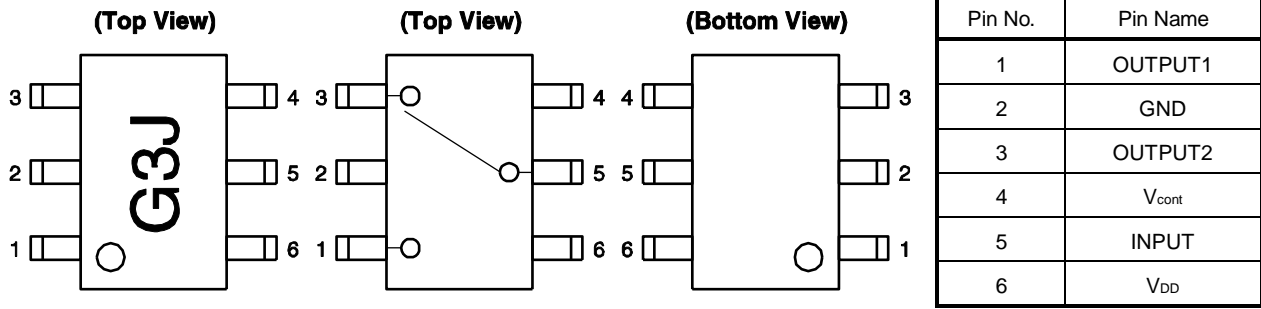

**TRUTH TABLE**

V <sub>cont</sub>	INPUT-OUTPUT1	INPUT-OUTPUT2
Low	OFF	ON
High	ON	OFF

**ABSOLUTE MAXIMUM RATINGS (T<sub>A</sub> = +25°C, unless otherwise specified)**

Parameter	Symbol	Ratings	Unit
Supply Voltage	V <sub>DD</sub>	+6.0	V
Switch Control Voltage	V <sub>cont</sub>	+6.0	V
Input Power	P <sub>in</sub>	+33	dBm
Operating Ambient Temperature	T <sub>A</sub>	-45 to +85	°C
Storage Temperature	T <sub>stg</sub>	-55 to +150	°C

**RECOMMENDED OPERATING RANGE (T<sub>A</sub> = +25°C, unless otherwise specified)**

Parameter	Symbol	MIN.	TYP.	MAX.	Unit
Supply Voltage	V <sub>DD</sub>	2.7	2.8	3.0	V
Switch Control Voltage (H)	V <sub>cont(H)</sub>	2.7	2.8	3.0	V
Switch Control Voltage (L)	V <sub>cont(L)</sub>	-0.2	0	0.2	V

**ELECTRICAL CHARACTERISTICS**

(T<sub>A</sub> = +25°C, V<sub>DD</sub> = 2.8 V, V<sub>cont</sub> = 2.8 V/0 V, DC cut capacitors = 56 pF, unless otherwise specified)

Parameter	Symbol	Test Conditions	MIN.	TYP.	MAX.	Unit
Insertion Loss 1	L <sub>INS1</sub>	f = 0.5 to 1.0 GHz	–	0.25	0.45	dB
Insertion Loss 2	L <sub>INS2</sub>	f = 1.0 to 2.0 GHz	–	0.30	0.50	dB
Insertion Loss 3	L <sub>INS3</sub>	f = 2.5 GHz	–	0.35	0.55	dB
Isolation 1	ISL <sub>1</sub>	f = 0.5 to 2.0 GHz	23	27	–	dB
Isolation 2	ISL <sub>2</sub>	f = 2.5 GHz	20	24	–	dB
Input Return Loss	RL <sub>in</sub>	f = 0.5 to 2.5 GHz	15	20	–	dB
Output Return Loss	RL <sub>out</sub>	f = 0.5 to 2.5 GHz	15	20	–	dB
0.1 dB Gain Compression Input Power <sup>Note</sup>	P <sub>in(0.1 dB)</sub>	f = 2.0 GHz	+25.5	+27.0	–	dBm
		f = 2.5 GHz	+25.5	+27.0	–	dBm
Supply Current	I <sub>DD</sub>		–	50	100	μA
Switching Control Current	I <sub>cont</sub>		–	4	20	μA
Switching Control Speed	t <sub>SW</sub>		–	0.3	2.0	μs

**Note** P<sub>in(0.1dB)</sub> is measured the input power level when the insertion loss increases more 0.1 dB than that of linear range.

**STANDARD CHARACTERISTICS FOR REFERENCE**

(T<sub>A</sub> = +25°C, V<sub>DD</sub> = 2.8 V, V<sub>cont</sub> = 2.8 V/0 V, DC cut capacitors = 56 pF, unless otherwise specified)

Parameter	Symbol	Test Conditions	MIN.	TYP.	MAX.	Unit
1 dB Gain Compression Input Power <sup>Note</sup>	P <sub>in(1 dB)</sub>	f = 2.0 GHz	–	+30.0	–	dBm

**Note** P<sub>in(1dB)</sub> is measured the input power level when the insertion loss increases more 1 dB than that of linear range.

**Caution** This device is used it is necessary to use DC cut capacitors.

The value of DC cut capacitors should be chosen to accommodate the frequency of operation, bandwidth, switching speed and the condition with actual board of your system. The range of recommended DC cut capacitor value is less than 100 pF.

EVALUATION CIRCUIT ( $V_{DD} = 2.8\text{ V}$ ,  $V_{cont} = 2.8\text{ V/0 V}$ , DC cut capacitors = 56 pF)

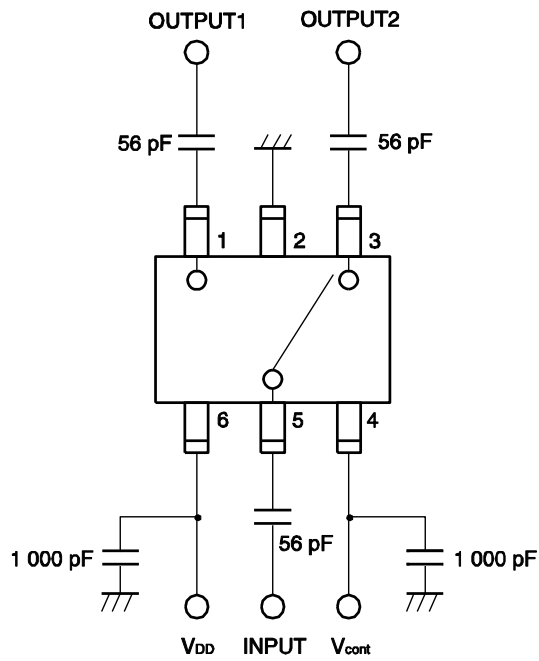

The application circuits and their parameters are for reference only and are not intended for use in actual design-ins.

ILLUSTRATION OF THE TEST CIRCUIT ASSEMBLED ON EVALUATION BOARD

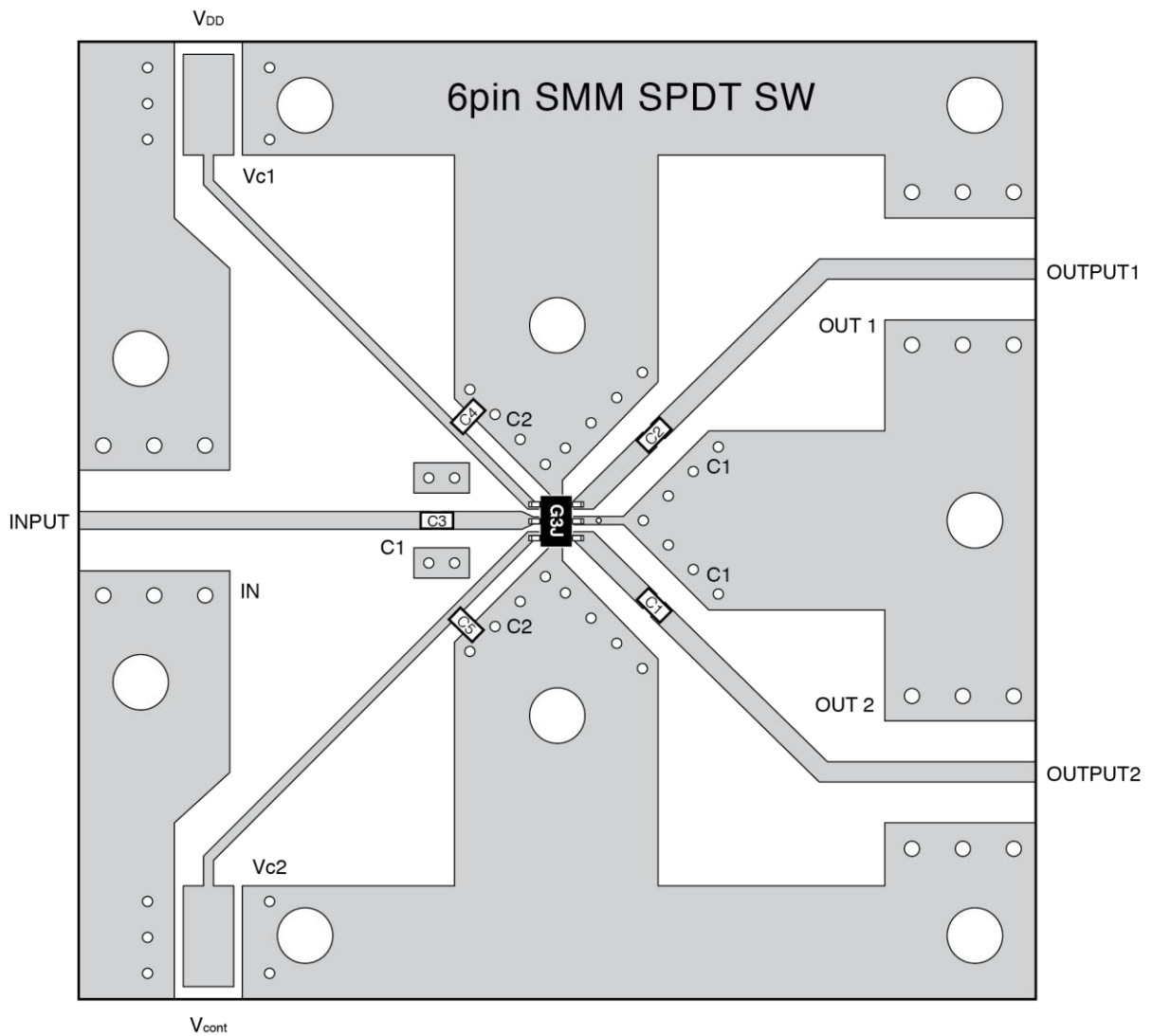

USING THE EVALUATION BOARD

Symbol	Values
C1, C2, C3	56 pF
C4, C5	1 000 pF

★ TYPICAL CHARACTERISTICS

( $T_A = +25^\circ\text{C}$ ,  $V_{DD} = 2.8\text{ V}$ ,  $V_{cont} = 2.8\text{ V/0 V}$ , DC cut capacitors = 56 pF, unless otherwise specified)

INPUT-OUTPUT1 •  
INSERTION LOSS vs. FREQUENCY

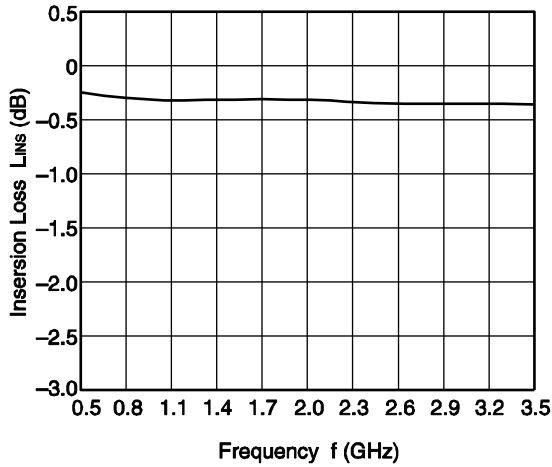

INPUT-OUTPUT2 •  
INSERTION LOSS vs. FREQUENCY

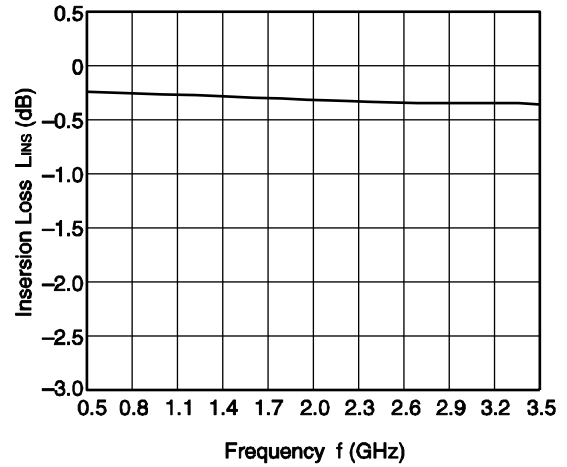

INPUT-OUTPUT1 •  
ISOLATION vs. FREQUENCY

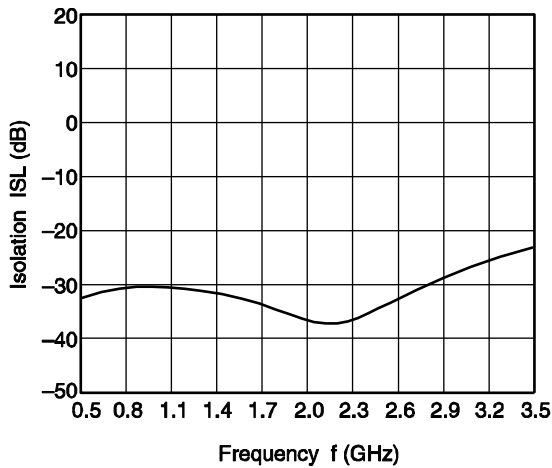

INPUT-OUTPUT2 •  
ISOLATION vs. FREQUENCY

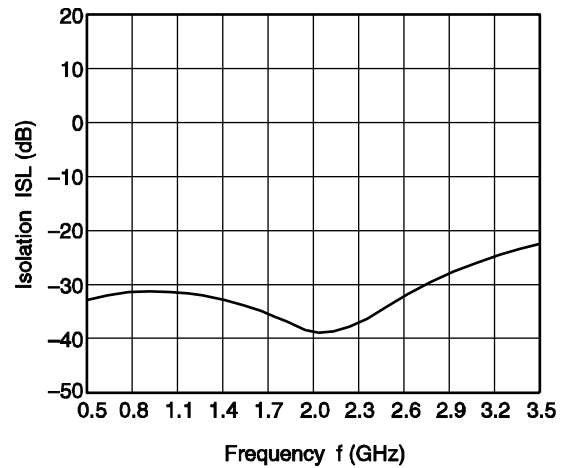

INPUT-OUTPUT1 •  
INPUT RETURN LOSS vs. FREQUENCY

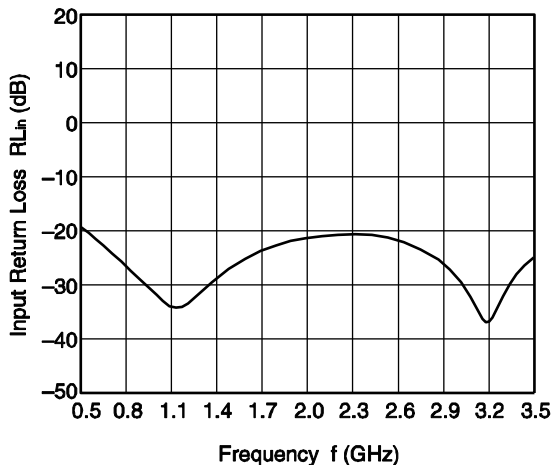

INPUT-OUTPUT2 •  
INPUT RETURN LOSS vs. FREQUENCY

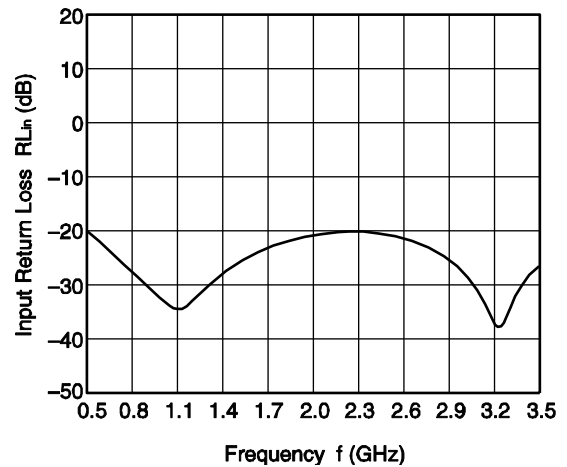

Remark The graphs indicate nominal characteristics.

INPUT-OUTPUT1  
OUTPUT RETURN LOSS vs. FREQUENCY

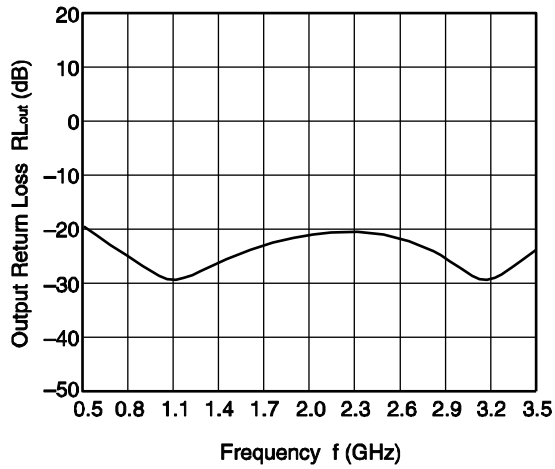

INPUT-OUTPUT2 •  
OUTPUT RETURN LOSS vs. FREQUENCY

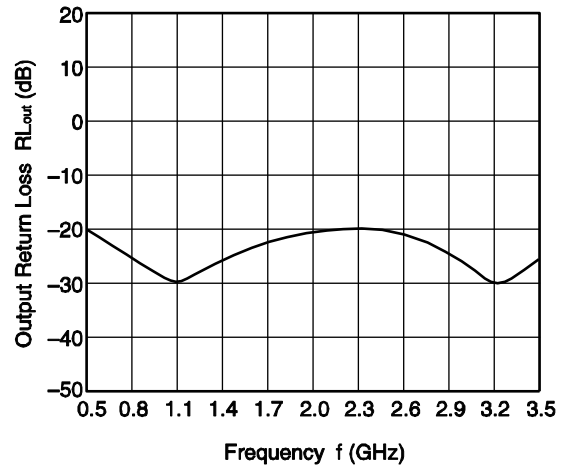

OUTPUT POWER vs. INPUT POWER

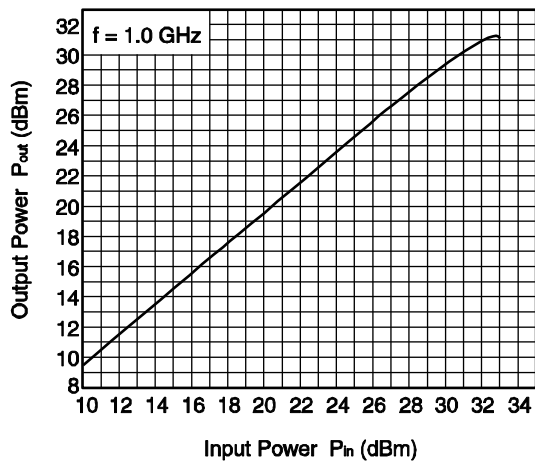

OUTPUT POWER vs. INPUT POWER

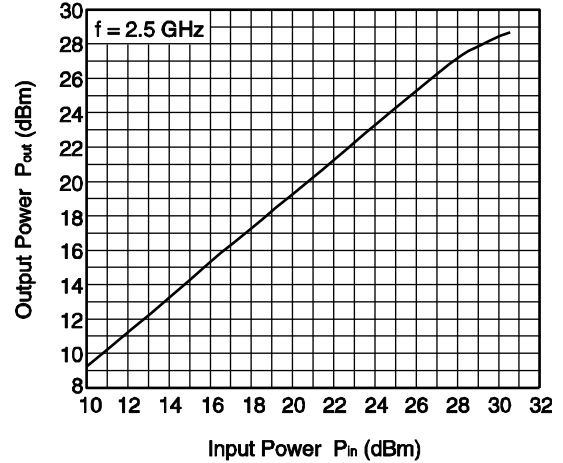

Remark The graphs indicate nominal characteristics.

PACKAGE DIMENSIONS

6-PIN SUPER MINIMOLD (UNIT: mm)

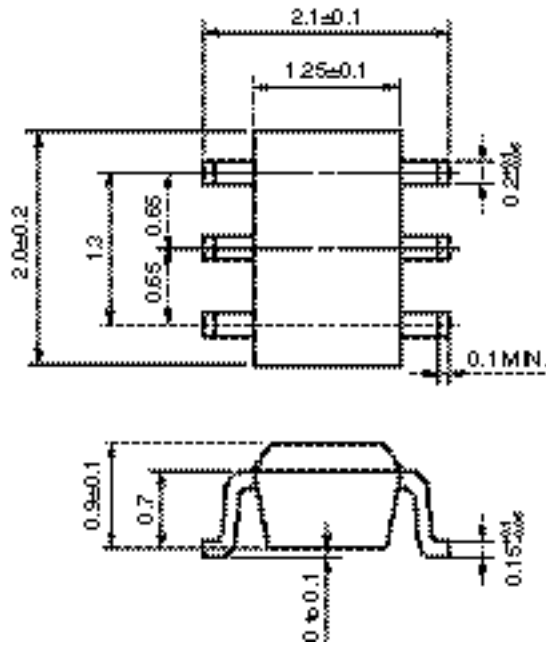



**RECOMMENDED SOLDERING CONDITIONS**

This product should be soldered and mounted under the following recommended conditions. For soldering methods and conditions other than those recommended below, contact your nearby sales office.

Soldering Method	Soldering Conditions	Condition Symbol
Infrared Reflow	Peak temperature (package surface temperature) : 260°C or below Time at peak temperature : 10 seconds or less Time at temperature of 220°C or higher : 60 seconds or less Preheating time at 120 to 180°C : 120±30 seconds Maximum number of reflow processes : 3 times Maximum chlorine content of rosin flux (% mass) : 0.2%(Wt.) or below	IR260
VPS	Peak temperature (package surface temperature) : 215°C or below Time at temperature of 200°C or higher : 25 to 40 seconds Preheating time at 120 to 150°C : 30 to 60 seconds Maximum number of reflow processes : 3 times Maximum chlorine content of rosin flux (% mass) : 0.2%(Wt.) or below	VP215
Wave Soldering	Peak temperature (molten solder temperature) : 260°C or below Time at peak temperature : 10 seconds or less Preheating temperature (package surface temperature) : 120°C or below Maximum number of flow processes : 1 time Maximum chlorine content of rosin flux (% mass) : 0.2%(Wt.) or below	WS260
Partial Heating	Peak temperature (pin temperature) : 350°C or below Soldering time (per side of device) : 3 seconds or less Maximum chlorine content of rosin flux (% mass) : 0.2%(Wt.) or below	HS350

**Caution Do not use different soldering methods together (except for partial heating).**

<p><b>Caution</b></p>	<p>GaAs Products</p>	<p>This product uses gallium arsenide (GaAs). GaAs vapor and powder are hazardous to human health if inhaled or ingested, so please observe the following points.</p> <ul style="list-style-type: none"> <li>• Follow related laws and ordinances when disposing of the product. If there are no applicable laws and/or ordinances, dispose of the product as recommended below.</li> </ul> <ol style="list-style-type: none"> <li>1. Commission a disposal company able to (with a license to) collect, transport and dispose of materials that contain arsenic and other such industrial waste materials.</li> <li>2. Exclude the product from general industrial waste and household garbage, and ensure that the product is controlled (as industrial waste subject to special control) up until final disposal.</li> </ol> <ul style="list-style-type: none"> <li>• Do not burn, destroy, cut, crush, or chemically dissolve the product.</li> <li>• Do not lick the product or in any way allow it to enter the mouth.</li> </ul>
-----------------------	----------------------	---