



APEX SERIES TRANSCEIVER MODULES

ZAXM-201-1

Integrated Transceiver Modules for ZigBee / IEEE 802.15.4

Evaluation Kit available: ZAXM-201-KIT-1

DESCRIPTION

Apex modules provide a cost-effective RF transceiver solution for 2.4GHz ZigBee and IEEE 802.15.4 data links and wireless networks.

The **ZAXM-201-1** Apex module is based on the Ember™ EM250 platform. It combines Ember's transceiver IC and 16-bit microprocessor with an onboard 100mW Power Amplifier. It's designed to support point to point, point to multi-point, and *EmberZNet* applications.

The APEX module provides over 4000 feet of range and is designed to deliver constant RF output power across the 2.1 to 3.6V voltage input, ensuring consistent performance over the entire life of the battery.

FEATURES

- 1 - 100mW output power, software controlled
- Designed for EmberZNet networks
- Miniature footprint: 1.00" x 1.275"
- Integrated PCB trace antenna
- Optional MMCX connector for external antenna
- 16 RF channels (Channel 16 operates at reduced power levels)
- Over 4000 feet of range
- Integrated hardware support for Ember InSight Development Environment
- Non-intrusive debug interface (SIF)
- AES 128 bit encryption
- Low power consumption
- Constant RF output power over 2.1–3.6 V voltage range
- FCC, IC, and CE certified
- RoHS compliant

APEX MODULE ZAXM-201-1



- Ember™ EM250 platform
- 128kB Flash memory
- 5kB SRAM
- 16-bit XAP2b microprocessor
- 16 general purpose I/O ports
- DMA – SPI, I²C and UART interfaces
- Integrated ADC with 12-bit resolution

APPLICATIONS

Automated Meter Reading

- In meter applications
- Thermostats
- In-home display units

Home & Building Automation

- Security
- HVAC control
- Lighting control
- Thermostats

Industrial Controls

- Food processing controls
- Traffic Management
- Sensor Networks
- Asset Management
- Barcode reader
- Patient Monitoring
- Glucose monitor

ORDERING INFORMATION

Part Number	Order Number	Description	Mins/Mults	Status
APEX ZAXM-201	ZAXM-201-1	Apex 100mW transceiver module PCB Trace Antenna	1,920 pcs / 160 pcs	Not Recommended For New Design
	ZAXM-201-1C	Apex 100mW transceiver MMCX connector installed		
	ZAXM-201-1-B	Apex 100mW transceiver module PCB Trace Antenna Bulk (1 tray)	32 pcs / 32 pcs	Discontinued
	ZAXM-201-1C-B	Apex 100mW transceiver MMCX connector installed Bulk (1 tray)		
	ZAXM-201-KIT-1	100mW Apex Module Kit	N/A	Discontinued

NOT RECOMMENDED
FOR NEW DESIGN

APEX MODULE BLOCK DIAGRAM

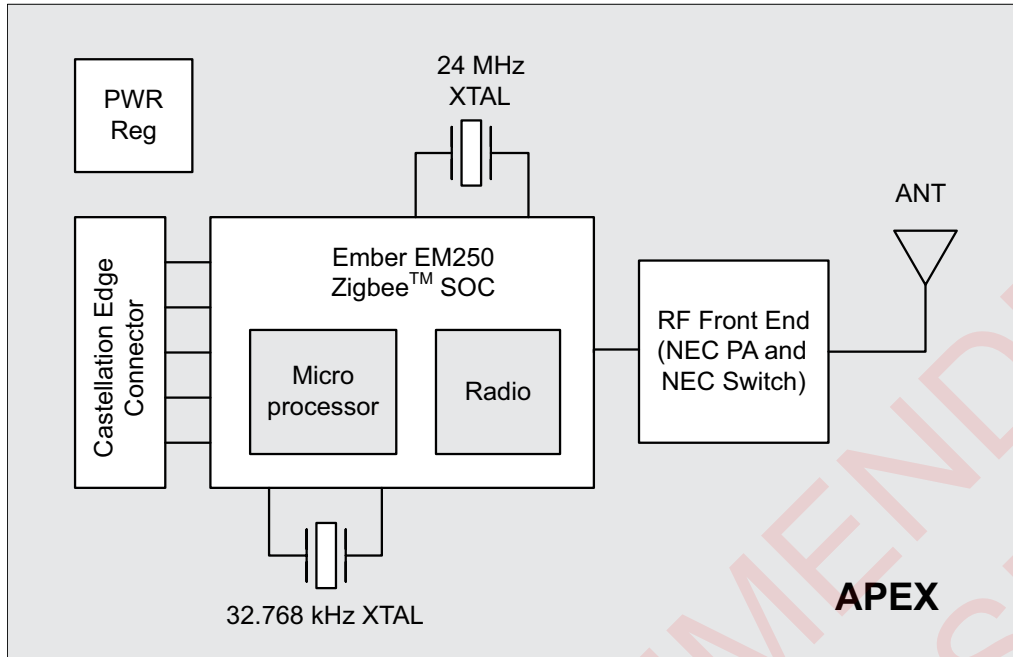

EVALUATION KIT

CEL provides Apex Evaluation Kits to assist users in evaluating Apex and Apex LT modules. The key components of the Apex Evaluation Kit are the interface board and the CEL's Apex radio module.

Apex module combines an Ember EM250 transceiver IC with an NEC high gain Power Amplifier and a high performance NEC RFIC switch.

The interface board features a serial communication interface, a power management module, peripherals such as potentiometer and accelerometer, and GPIO headers. The Evaluation Kit also contains four AA batteries and two USB cables.

For more detail information regarding Apex Evaluation Kit, refer to the **Apex Module Evaluation Kit User Guide** document. (http://www.cel.com/pdf/misc/apexseries_ug.pdf)



- Kit Contents:**
- Evaluation Boards (2)
 - ZigBee Modules (2)
 - USB Cables (2)
 - AA Batteries (4)
 - Technical Information CD (1)

Order Number	Description
ZAXM-201-KIT-1	Engineering Evaluation Kit

TABLE OF CONTENTS

Introduction and Overview

Description..... 1

Features..... 1

Applications..... 1

Ordering Information..... 2

Apex Module Block Diagram..... 3

Evaluation Kit..... 3

System Level Function

Apex Module Microprocessor..... 5

Antenna..... 5

Modes of Operation (TX, RX, Sleep)..... 7

Processor ACTIVE..... 7

Processor IDLE..... 7

Power Amplifier Regulator Control Line..... 8

SIF Interface..... 8

Host Protocol Interface Commands..... 8

Electrical Specification

Absolute Maximum Ratings..... 9

Recommended (Operating Condition)..... 9

DC Characteristics..... 9

RF Characteristics..... 10

Pin Signal & Interfaces

Pin Signals I/O Configuration..... 10

Apex I/O Pin Assignment..... 11

Apex Module Dimensions..... 12

PCB Copper Pattern Layout..... 13

PCB Stencil Pattern..... 13

PCB Keep-Out Areas..... 14

Processing..... 15

Agency Certifications..... 17

Shipment, Storage & Handling..... 18

References & Revision History..... 19

APEX MODULE MICROPROCESSOR

APEX modules provide 16 GPIO ports that are shared with other peripheral or alternate functions. The alternate functions can be utilized on a variety of different GPIOs as detailed on the following page in the Table of Pin Assignments. All the GPIO pads are selectable as input, output, or bi-directional and have an internal pull-up or pull-down.

The integrated Serial Controller SC1 can be configured for SPI (master-only), I²C (master-only), or UART functionality. The Serial Controller SC2 can be configured for SPI (master or slave) or I²C (master-only) operation. The integrated ADC can sample analog signals from three GPIO pins single-ended or differentially. The integrated voltage reference VREF for the ADC can be made available to a GPIO port.

Please consult the Ember EM250 datasheet for details on configuring and controlling the information flow of the APEX module interface ports to setup the following:

- GPIO Data Registers
- Alternate function routing
- External Interrupts
- Serial Controller SC1 module (UART mode, SPI Master mode, I²C Master mode)
- Serial Controller SC2 module (SPI modes, I²C Master mode)
- General Purpose Timers
- ADC Module
- Event Manager

ANTENNA

The APEX module includes an integrated PCB trace antenna. An optional MMCX connector can be specified, enabling connection to a 50-ohm external antenna of the user's choice. See Ordering Information.

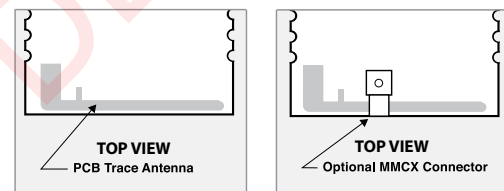

The PCB antenna employs an F-Antenna topology that is compact and supports an omni-directional radiation pattern. To maximize antenna efficiency, an adequate ground plane must be provided on the host PCB. If positioned correctly, the ground plane on the host board under the module can contribute significantly to antenna performance.

The position of the module on the host board and overall design of the product enclosure contribute to antenna performance. Poor design effects radiation patterns and can result in reflection, diffraction, and/or scattering of the transmitted signal. Measured radiation patterns of these modules are available from California Eastern Labs and can be used to benchmark design performance.

Here are some design guidelines to help ensure antenna performance:

- Never place the ground plane or route copper traces directly underneath the antenna portion of the module.
- Never place the antenna close to metallic objects.
- In the overall design, ensure that wiring and other components are not placed near the antenna.
- Do not place the antenna in a metallic or metallized plastic enclosure.
- Keep plastic enclosures 1 cm or more from the antenna in any direction.

ANTENNA (Continued)

Orientation of EUT Peak Gain was in the Horizontal Position. The receiver antenna was in the Horizontal Position.

Frequency = 2405 MHz

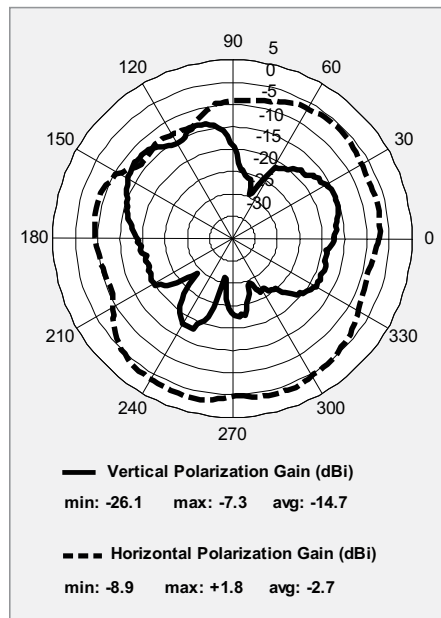

Frequency = 2440 MHz

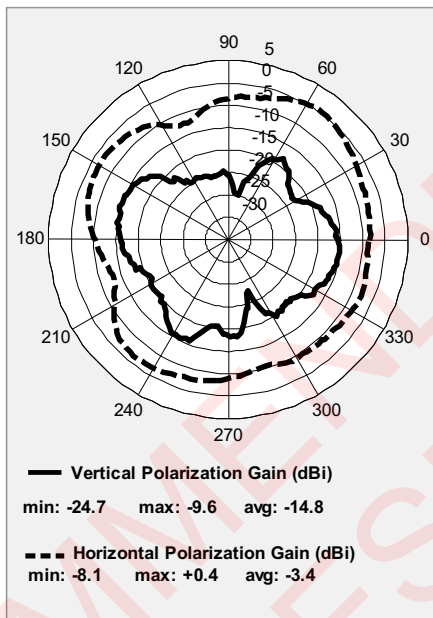

Frequency = 2480 MHz

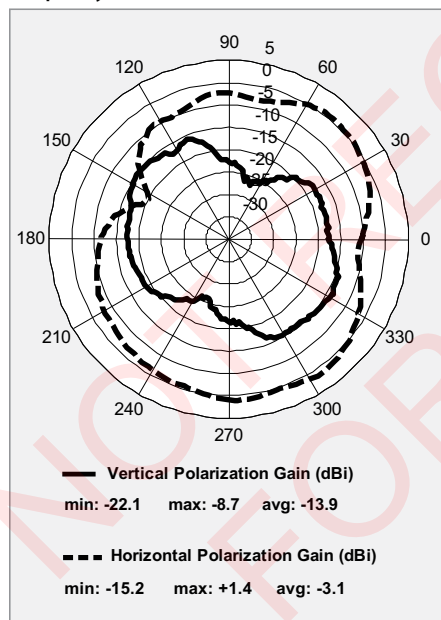

MODES OF OPERATION

The Apex supports three power modes: Processor ACTIVE, processor IDLE, and DEEP SLEEP.

Processor ACTIVE

In this mode all operations are running normally.

Processor IDLE

In this mode the processor stops code execution of the XAP2b microprocessor until any interrupt occurs or external SIF wake up command is seen. The radio is operating normally in this mode.

Deep Sleep

To achieve the lowest power consumption, the module can be set in DEEP SLEEP mode. In this mode most of the functionalities of the modules are turned off with the exception of the critical functions such as GPIO pads and RAM that is powered by the high voltage supply (DCC_PADS).

The module can be taken out of DEEP SLEEP in 3 ways:

- Configuring the sleep timer to generate an interrupt after some periods of time.
- Issuing external interrupt signal.
- Issuing commands through the SIF interface.

In DEEP SLEEP the current consumption of the module will drop to $5.0\mu\text{A}$ ($5.5\mu\text{A}$ with optional 32.768kHz oscillator enabled).

For more detail information on modes of operation refer to Ember EM250 datasheet available at Ember's website (www.ember.com)

POWER AMPLIFIER REGULATOR CONTROL LINE

The APEX modules include a separate 1.8V regulator for a power amplifier bias that enables consistent module output performance over the wide 2.1 – 3.6V voltage range. To prevent excessive sleep currents, this regulator should be disabled when the module is in sleep mode. An external pull up resistor option is provided on each module (R6) that allows the regulator to be constantly enabled. This option increases the sleep current of the module to a point well above the specified values.

SPECIFICATIONS – GPIO7 (APEX)

Parameter	Min	Typ	Max	Unit
Regulator enable voltage	0.95			V
Regulator disable voltage			0.4	V
Enable line current (VEN = 0)			0.1	μA
Enable line current (VEN = VDD)			10	μA
Turn on Time			250	μsec

On the APEX module, the regulator control line is connected to the module via the GPIO7 port. The host can drive this port as it does on the APEX LT module, but it can also use the default serial digital function of this port as an external voltage regulator enable. Please consult the EM250 datasheet for details on the operation of this function. Note that both these approaches preclude the use of the GPIO7 port for any other functions, including use as the ADC3 input.

If the application does not put the module to sleep or if sleep current is not an issue, the power amplifier regulator may be permanently enabled by tying the control line high. In this setup, the sleep current will increase by 80 μA over the 5 μA Standby Current figure provided in Electrical Specifications.

SIF INTERFACE

The APEX module provide access to the SIF module programming and debug interface.

Consult the EM250 datasheet for further details on the following SIF features:

- Production Testing
- Firmware Download
- Product Control and Characterization
- XAP2b Code Development (APEX only)

HOST PROTOCOL INTERFACE COMMANDS

For information on Host Protocol Interface Commands and for other software-related documents refer to Ember’s website:

http://www.ember.com/products_documentation.html

ABSOLUTE MAXIMUM RATINGS

Rating	Value	Unit
Power Supply Voltage	3.6	Vdc
Voltage on Any Digital Pin	VDD + 0.3, Max 3.6	Vdc
RF Input Power	+10	dBm
Storage Temperature Range	-45 to 125	°C

Note: Exceeding the maximum ratings may cause permanent damage to the module or devices.

RECOMMENDED (OPERATING CONDITIONS)

Characteristic	Min	Typ	Max	Unit
Power Supply Voltage (VDD)	2.1		3.6	V
Input Frequency	2405		2480	MHz
Ambient Temperature Range	-40	25	85	°C
Logic Input Low Voltage	0		20% VDD	V
Logic Input High Voltage	80% VDD		VDD	V

DC CHARACTERISTICS (@ 25°C, VDD = 3.3V unless otherwise noted)

Parameter	Min	Typ	Max	Unit
Logic Input Low	0		0.2 x VDD	V
Logic Input High	0.8 x VDD		VDD	V
Logic Output Low	0		0.18 x VDD	V
Logic Output High	0.82 x VDD		VDD	V
Output source current (standard pad – APEX)			4	mA
Output sink current (standard pad – APEX)			4	mA
Output source current (high current pad – APEX)			8	mA
Output sink current (high current pad – APEX)			8	mA
I/O pin pull-up and pull-down resistor (APEX)		30		kΩ
Power Consumption				
<i>Transmit Mode (100mW output):</i>				
APEX		170		mA
<i>Receive Mode:</i>				
APEX		37		mA
<i>Standby Mode:</i>				
10mW			5	μA
100mW			5	μA

RF CHARACTERISTICS (@ 25°C, VDD = 3.3V unless otherwise noted)

Parameter	Min	Typ	Max	Unit
General Characteristics				
RF Frequency Range	2400		2483.5	MHz
RF Data Rate		250		kbps
Microcontroller Operating Frequency		12		MHz
Flash Memory		128		kB
RAM		5		kB
Transmitter				
Nominal Output Power		20		dBm
Programmable Output Power Range		32		dB
Error Vector Magnitude		15	35	%
Receiver				
Receiver Sensitivity (1% PER) – normal mode	-92	-96		dBm
Receiver Sensitivity (1% PER) – <i>boost mode</i> *	-93	-97		dBm
Saturation (Maximum Input Level) (1% PER)	0			dBm
<i>802.15.4 Adjacent Channel Rejection:</i>				
APEX	35			dB
802.15.4 Alternate Channel Rejection	40			dB
<i>802.11 g Rejection (±10 MHz):</i>				
APEX	40			dB

***Boost Mode** is an optional software-selectable high performance mode designed to increase receiver sensitivity.

Note: Refer to Ember EM250 datasheet for additional details.

PIN SIGNALS I/O PORT CONFIGURATION

The APEX module has a 28 edge I/O interface for connection to the user’s host board. *Figure 1* shows the layout of the 28 edge castellations.

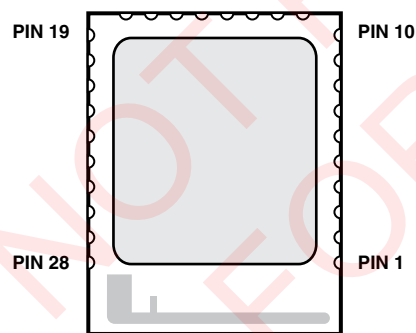

Figure 1 (Top View)

APEX I/O PIN ASSIGNMENTS

Pin #	Name	Type	Description
1	GROUND	GND	Ground
2	GROUND	GND	Ground
3	GROUND	GND	Ground
4	VDD	PI	Power Supply Input
5	RSTB	DI	Reset, active low
6	GPIO11	DI/DO	General Purpose Digital I/O, SC1 UART CTS, SC1 SPI master clock, or Capture Input A of Timer 2
7	GPIO12	DI/DO	General Purpose Digital I/O, SC1 UART RTS, or Capture Input B of Timer 2
8	GPIO0	DI/DO	General Purpose Digital I/O, SC2 SPI MOSI, or Capture Input A of Timer 1
9	GPIO1	DI/DO	General Purpose Digital I/O, SC2 SPI MISO, SC2 I ² C SDA, or Capture Input A of Timer 2
10	GPIO2	DI/DO	General Purpose Digital I/O, SC2 SPI master clock, SC2 I ² C SCL, or Capture Input B of Timer 2
11	GPIO3	DI/DO	General Purpose Digital I/O, SC2 SPI slave select, or Capture Input B of Timer 1
12	GPIO4	DI/DO/AI	General Purpose Digital I/O, ADC Input 0, or PTI frame signal
13	GPIO5	DI/DO/AI	General Purpose Digital I/O, ADC Input 1, or PTI data signal
14	GPIO6	DI/DO/AI	General Purpose Digital I/O, ADC Input 2, Timer 2 Clock Input, or Timer 1 Enable
15	GPIO7	DO	Regulator Enable, active high (see section of "Power Amplifier Regulator Control Line")
16	GPIO8	DI/DO/AO	General Purpose Digital I/O, ADC Reference Output, Timer 1 Clock Input, Timer 2 Enable, or Source A Interrupt
17	GPIO9	DI/DO	General Purpose Digital I/O, SC1 TXD, SC1 MO, SC1 I ² C Data, or Capture Input A of Timer 1
18	GPIO10	DI/DO	General Purpose Digital I/O, SC1 RXD, SC1 MI, SC1 I ² C Clock, or Capture Input B of Timer 1
19	CLK	DI	SIF Interface clock
20	MISO	DO	SIF Interface master in/slave out
21	MOSI	DI	SIF Interface master out/slave in
22	LOADB	DI/DO	SIF Interface load strobe
23	GPIO16	DI/DO	General Purpose Digital I/O, Output B of Timer 1, Capture Input B of Timer 2, or Source D Interrupt
24	GPIO15	DI/DO	General Purpose Digital I/O, Output A of Timer 1, Capture Input A of Timer 2, or Source C Interrupt
25	GPIO14	DI/DO	General Purpose Digital I/O, Output B of Timer 2, Capture Input B of Timer 1, or Source B Interrupt
26	GPIO13	DI/DO	General Purpose Digital I/O, Output A of Timer 2, or Capture Input A of Timer 1
27	GROUND	GND	Ground
28	GROUND	GND	Ground

Unused I/O pins should be left unconnected and the pin state set via the Host Protocol.

DI = Digital Input

PI = Power Input

DO = Digital Output

GND = Ground

AI = Analog Input

AO = Analog Output

DIMENSIONS: ZAXM-201-1 Apex Dimensions in inches. Tolerances = +/-0.005" unless otherwise noted.

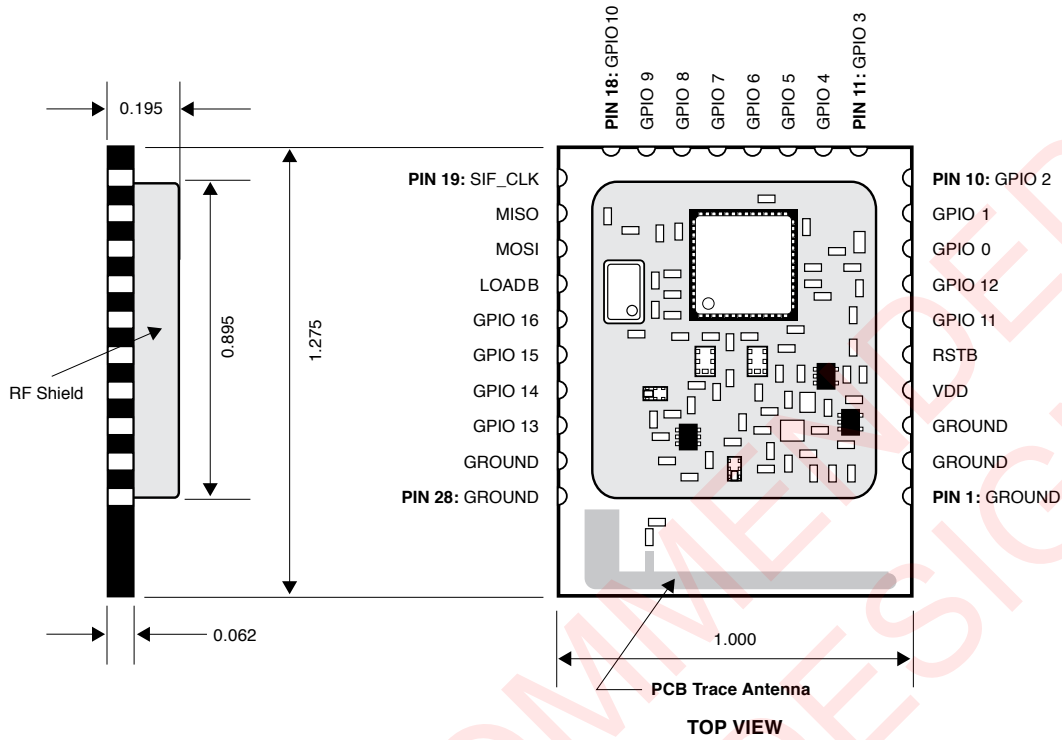

DIMENSIONS: ZAXM-201-1C Apex with Optional MMCX Connector

Dimensions in inches. Tolerances = +/-0.005" unless otherwise noted.

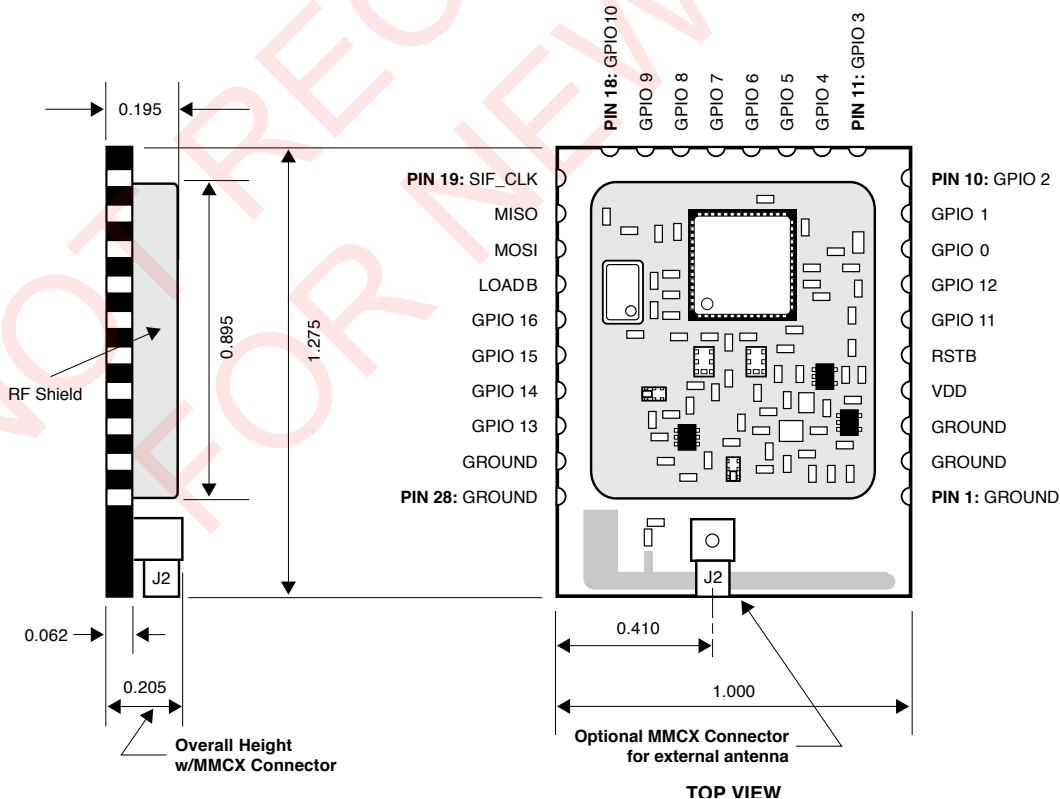

PCB COPPER PATTERN LAYOUT: Apex

Dimensions in inches. Tolerances = +/-0.005" unless otherwise noted.

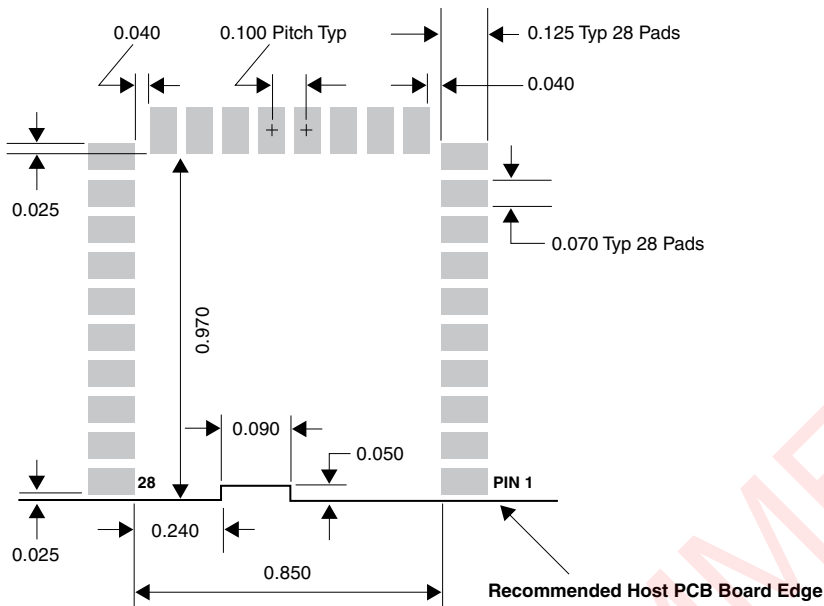

PCB PASTE STENCIL PATTERN: Apex

Dimensions in inches. Tolerances = +/-0.005" unless otherwise noted.

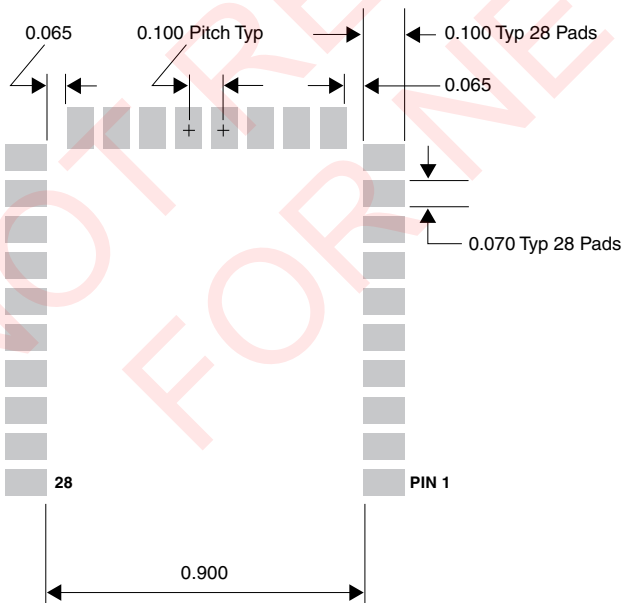

PCB Keep-out areas: Apex

Dimensions in inches. Tolerances = +/-0.005" unless otherwise noted.

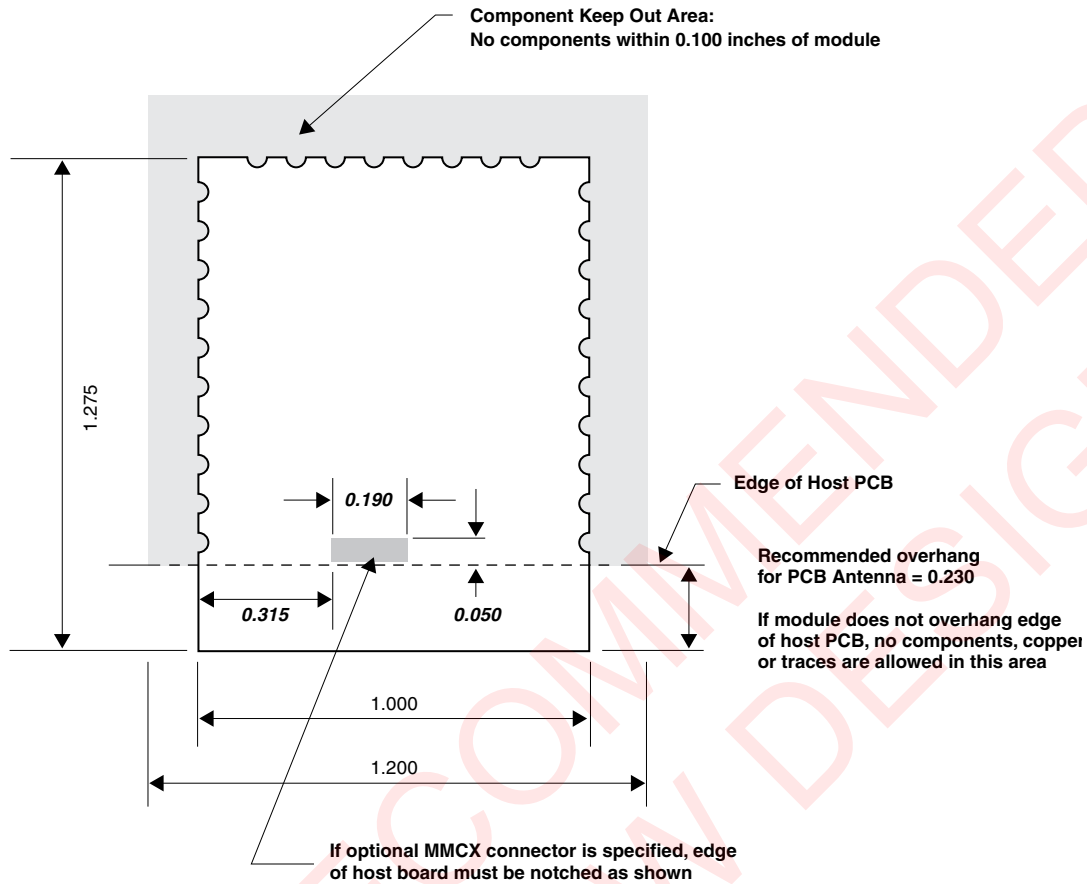

For optimum antenna performance, The APEX module should be mounted with the PCB trace antenna overhanging the edge of the host board. To further improve performance, a ground plane may be placed on the host board under the module, up to the PCB edge. The installation of an uninterrupted ground plane on a layer directly beneath the module will also allow you to run traces under this layer. CEL can provide assistance with your PCB layout.

PROCESSING

Recommended Reflow Profile

Parameters Values

Ramp up rate (from Tsoakmax to Tpeak)	3°/sec max
Minimum Soak Temperature	150°C
Maximum Soak Temperature	200°C
Soak Time	60-120 sec
TLiquidus	217°C
Time above TL	60-150 sec
Tpeak	260 + 0°C
Time within 5° of Tpeak	20-30 sec
Time from 25° to Tpeak	8 min max
Ramp down rate	6°C/sec max

Achieve the brightest possible solder fillets with a good shape and low contact angle.

Pb-Free Soldering Paste

Use of "No Clean" soldering paste is strongly recommended, as it does not require cleaning after the soldering process.

Note: The quality of the solder joints on the castellations ('half vias') where they contact the host board should meet the appropriate IPC specification. See IPC-A-610-D Acceptability of Electronic Assemblies, section 8.2.4 Castellated Terminations.

Cleaning

In general, cleaning the populated modules is strongly discouraged. Residuals under the module cannot be easily removed with any cleaning process.

- Cleaning with water can lead to capillary effects where water is absorbed into the gap between the host board and the module. The combination of soldering flux residuals and encapsulated water could lead to short circuits between neighboring pads. Water could also damage any stickers or labels.
- Cleaning with alcohol or a similar organic solvent will likely flood soldering flux residuals into the two housings, which is not accessible for post-washing inspection. The solvent could also damage any stickers or labels.
- Ultrasonic cleaning could damage the module permanently.

The best approach is to consider using a "no clean" soldering paste and eliminate the post-soldering cleaning step.

Optical Inspection

After soldering the Module to the host board, consider optical inspection to check the following:

- Proper alignment and centering of the module over the pads.
- Proper solder joints on all pads.
- Excessive solder or contacts to neighboring pads, or vias.

PROCESSING *(Continued)***Repeating Reflow Soldering**

Only a single reflow soldering process is encouraged for host boards.

Wave Soldering

If a wave soldering process is required on the host boards due to the presence of leaded components, only a single wave soldering process is encouraged.

Hand Soldering

Hand soldering is possible. Use a soldering iron temperature setting equivalent to 350°C, follow IPC recommendations/ reference document IPC-7711.

Rework

The Apex LT Module can be unsoldered from the host board. Use of a hot air re-work tool and hot plate for pre-heating from underneath is recommended. Avoid overheating.

!Warning Never attempt a rework on the module itself, e.g. replacing individual components. Such actions will terminate warranty coverage.

Additional Grounding

Attempts to improve module or system grounding by soldering braids, wires, or cables onto the module RF shield cover is done at the customers own risk. The numerous ground pins at the module perimeter should be sufficient for optimum immunity to external RF interference.

AGENCY CERTIFICATIONS

FCC Part 15.247 Module Certified (Mobile)

The APEX modules comply with Part 15 of the Federal Communications Commission rules and regulations. To meet the FCC Certification requirements, the user must meet these regulations:

- The text on the FCC ID label provided with the module must be placed on the outside of the final product.
- The modules may only use the antennas that have been tested and approved with these modules:
 - The on-board PCB trace antenna
 - Nearson S131CL-5-RMM-2450S antenna.

To meet the Section 15.209 emission requirements in the restricted frequency bands of Section 15.205, the transceiver transmitter power for the APEX (EM250) module needs to be reduced from the typical maximum setting on the upper two channels (2475 MHz and 2480 MHz). Maximum values are TBD.

Per Section 2.109, the APEX module have been certified by the FCC for use with other products without additional certification. Any modifications to this product may violate the rules of the Federal Communications Commission and make operation of the product unlawful.

Per Sections 15.107 and 15.109, the user's end product must be tested for unintentional radiators compliance.

Per Section 47 C.F.R. Sec.15.105(b), The APEX module is certified as mobile devices for the FCC radiation exposure limits set forth for an uncontrolled environment. The antennas used with this module must be installed to provide a separation distance of at least 8 inches (20cm) from all persons. If the module is to be used in a handheld application, the user is responsible for passing additional FCC part 2.1091 rules (SAR) and FCC Guidelines for Human Exposure to Radio Frequency Electromagnetic Fields, OET Bulletin and Supplement C.

IC Certification – Canada

The APEX module is IC certified. The labeling requirements for Industry Canada are similar to those of the FCC. A visible label on the outside of the final product must display the IC labeling. The user is responsible for the end product to comply with IC ICES-003 (Unintentional radiators).

CE Certification – Europe

The APEX module is CE certified. The CE marking must be affixed legibly and indelibly to a visible location on the user's product.

FCC Approved Antennas

- **Integrated PCB trace antenna**
- **Nearson S131CL-5-RMM-2450S** – A 2.4GHz Dipole antenna with a 5 inch cable and a right angle MMCX connector.

SHIPMENT, HANDLING, AND STORAGE

Shipment

The Apex Module is delivered in trays of 32. Each package consists of 5 trays and therefore the total module quantity per package is 160.

Handling

The Apex Module is designed and packaged to be processed in an automated assembly line.

!Warning The Apex Module contains a highly sensitive electronic circuitry. Handling without proper ESD protection may destroy or damage the module permanently.

!Warning According to JEDEC ISP, the Apex Module is moisture sensitive devices. Appropriate handling instructions and precautions are summarized in Section 2.1. Read carefully to prevent permanent damage due to moisture intake.

Moisture Sensitivity Level (MSL)

MSL 3, per J-STD-033

NOT RECOMMENDED
FOR NEW DESIGN

REFERENCES & REVISION HISTORY

References

Reference Documents
Apex Module Evaluation Kit User Guide
Ember EM250 Datasheet (June 29, 2007)

Revision History

Previous Versions	Changes to Current Version	Page
0002/3-00-07-00-000 (Issue A) May 7, 2008	Initial preliminary datasheet.	N/A
0002-00-07-00-000 (Issue B) January 22, 2009	Datasheet Unification for ZigBee product line	N/A
0002-00-07-00-000 (Issue C) April 29, 2010	The following corrections/changes were made: On page 11, pin 10 was changed from GND to GPIO2 and the module height was changed from 0.162" to 0.195". On page 6, the deep sleep mode current consumption was changed to 5.0µA.	6, 11
0002-00-07-00-000 (Issue C) November 2, 2012	Updated Minimum Ordering Quantity	1

Disclaimer

- The information in this document is current as of the published date. The information is subject to change without notice. For actual design-in, refer to the latest publications of CEL data sheets or data books, etc., for the most up-to-date specifications of CEL products. Not all products and/or types are available in every country. Please check with an CEL sales representative for availability and additional information.
- No part of this document may be copied or reproduced in any form or by any means without the prior written consent of CEL. CEL assumes no responsibility for any errors that may appear in this document.
- CEL does not assume any liability for infringement of patents, copyrights or other intellectual property rights of third parties by or arising from the use of CEL products listed in this document or any other liability arising from the use of such products. No license, express, implied or otherwise, is granted under any patents, copyrights or other intellectual property rights of CEL or others.
- Descriptions of circuits, software and other related information in this document are provided for illustrative purposes in semiconductor product operation and application examples. The incorporation of these circuits, software and information in the design of a customer's equipment shall be done under the full responsibility of the customer. CEL assumes no responsibility for any losses incurred by customers or third parties arising from the use of these circuits, software and information.
- While CEL endeavors to enhance the quality, reliability and safety of CEL products, customers agree and acknowledge that the possibility of defects thereof cannot be eliminated entirely. To minimize risks of damage to property or injury (including death) to persons arising from defects in CEL products, customers must incorporate sufficient safety measures in their design, such as redundancy, fire-containment and anti-failure features.