

**MeshConnect ISP / WNA
(ZIC2410USB-WNA-1)
User Guide
0007-05-08-06-001
(REV A)**

TABLE OF CONTENTS

INTRODUCTION	3
CEL MESHCONNECT ISP / WNA FEATURES	3
GETTING STARTED	4
USB SETUP	4
MESHCONNECT ISP / WNA CONTENTS	4
SYSTEM REQUIREMENTS	5
USB DRIVER AND SOFTWARE INSTALLATION	6
DECOMPRESSING THE USB DRIVERS	6
INSTALLING THE USB DRIVERS	9
INSTALLING THE NEW HARDWARE ON THE COMPUTER	10
LOCATING THE COM PORT ASSIGNMENT	13
INSTALLING THE CEL <i>DEVICE-PROGRAMMER</i> AND <i>PACKET-ANALYZER</i> SOFTWARE	14
CEL MESHCONNECT ISP / WNA FRONT-END SOFTWARE	15
HARDWARE	16
CONNECTING THE CEL MESHCONNECT ISP / WNA	16
HARDWARE DESCRIPTION	16
ISP TARGET INTERFACE	19
PROGRAMMING THE CEL MESHCONNECT ISP / WNA FIRMWARE	22
REVISION HISTORY	22

INTRODUCTION

The CEL MeshConnect ISP / WNA USB dongle (ZIC2410USB-WNA-1) coupled with the *CEL Device-Programmer* and *CEL Packet Analyzer* software tools can serve as all-in-one development tool with the push of a button. The dongle is capable of In-System Programming (ISP) both the CEL MeshConnect IC and MeshConnect-based modules. The dongle is also capable of functioning as a Wireless Network Analyzer (WNA), or packet sniffer, when debugging wireless applications.

CEL MeshConnect ISP / WNA Features

- Powered from USB, doesn't require an external power supply
- USB 2.0 compliant (full speed, 12 Mbps)
- Software / Firmware upgradeable to support future releases
- Compatible with SNAP™ software from Synapse Wireless
- Compatible with *CEL Device Programmer* software tool (v3.50 and later)
 - Supports the CEL MeshConnect IC and MeshConnect-based modules
 - Supports Security Settings programming
 - Supplies Target Voltage of 3.0 V
- Compatible with *CEL Packet-Analyzer* software tool (v3.32 and later)
 - Supports CEL MeshConnect Normal (250 kbps), Turbo (500 kbps) and Premium (1 Mbps) wireless data rates



Figure 1: CEL MeshConnect ISP / WNA USB Dongle

The CEL MeshConnect ISP / WNA is supported by *CEL Device-Programmer* and *CEL Packet-Analyzer* software tools. Updated versions of the aforementioned software can be found under the Software Downloads section of the 802.15.4 / ZigBee products at <http://www.cel.com>.

GETTING STARTED

Please read the following section before connecting the MeshConnect ISP / WNA USB dongle to either the computer or target. Follow these four simple steps to get started using the MeshConnect ISP / WNA dongle.

1. Install USB Drivers and Software
 - a. Install the USB Drivers for the Silicon Labs CP2102 USB to UART Bridge
 - b. Install the *CEL Device-Programmer* software, version 3.50 or higher
 - c. Install the *CEL Packet-Analyzer* software, version 3.32 or higher
2. Connect the MeshConnect ISP / WNA to the computer and install the appropriate drivers. Note the driver will install twice (once for the USB interface and a second time for the UART interface)
3. Invoke the desired software (i.e. *CEL Device-Programmer* or *CEL Packet-Analyzer*)
4. Connect the MeshConnect ISP / WNA to the target if performing In-System Programming

USB Setup

In order to use the MeshConnect ISP / WNA, the requirement exists to first install the Silicon Labs CP2102 USB drivers and the CEL software tools first. Do not connect the ISP / WNA dongle to the computer before completing the USB driver installation as described in later sections of this document.

MeshConnect ISP / WNA Contents

- CEL MeshConnect ISP / WNA USB dongle
- 12 Inch 1x6 Ribbon Cable



Figure 2: CEL MeshConnect ISP / WNA USB Dongle with Ribbon Cable

System Requirements

The minimum hardware and software requirements are:

- Pentium class (or compatible) processor (Pentium III and above is recommended)
- 256 Megabytes of RAM
- 125 Megabytes Free Hard Disk Space for installation of CEL software tools
- Windows® 2000 Professional or Windows XP Professional
- USB port, self-powered

NOTE #1: Windows Vista is not supported. The CEL software tools have been made to work by operating them in Windows XP Compatibility Mode from within Windows Vista, however proper operation is not guaranteed.

NOTE #2: Windows 7 is not supported.

USB DRIVER AND SOFTWARE INSTALLATION

In order to use the CEL MeshConnect ISP / WNA USB dongle it is required to install the USB driver. Do not connect the MeshConnect ISP / WNA dongle to the computer prior to running the USB driver installation. The USB driver installation must be completed outside of the CEL software tools installation.

NOTE: The CEL MeshConnect ISP / WNA USB dongle, when operated in WNA-mode, is only compatible with *CEL Packet-Analyzer* v3.32 or higher. The latest version can be downloaded from the CEL website at <http://www.cel.com>.

The USB driver installation is a three-step process. The first step decompresses the USB drivers and copies them to your computer's hard drive. The second step installs the USB drivers, such that when a valid device is detected the drivers are automatically installed. The final step is the automatic installation of the drivers.

Decompressing the USB Drivers

1. Start the decompression of the USB drivers by executing the **CP2101_drivers.exe** executable file located on the CD-ROM at **\ZIC2410\Tools\Others\CP210X_Driver**. The screen in Figure 3 will be displayed. Click the **Next** button.

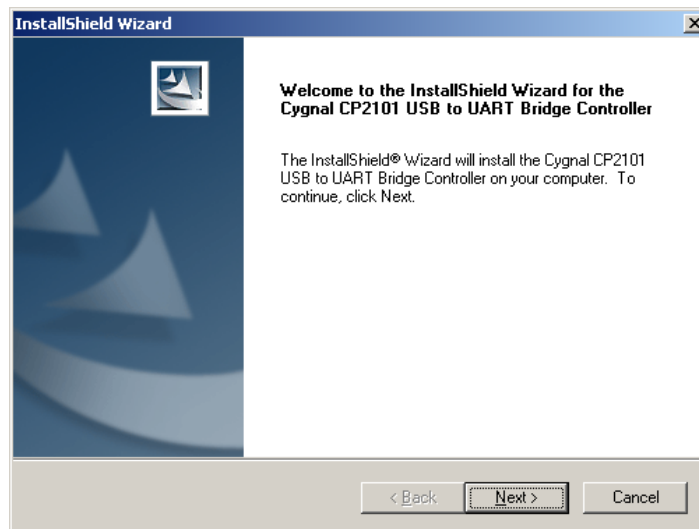

Figure 3: CP2101 USB Driver Setup Wizard

2. The License Agreement will be displayed as shown in Figure 4. Once you've read through and agreed to the agreement, click the **Yes** button.

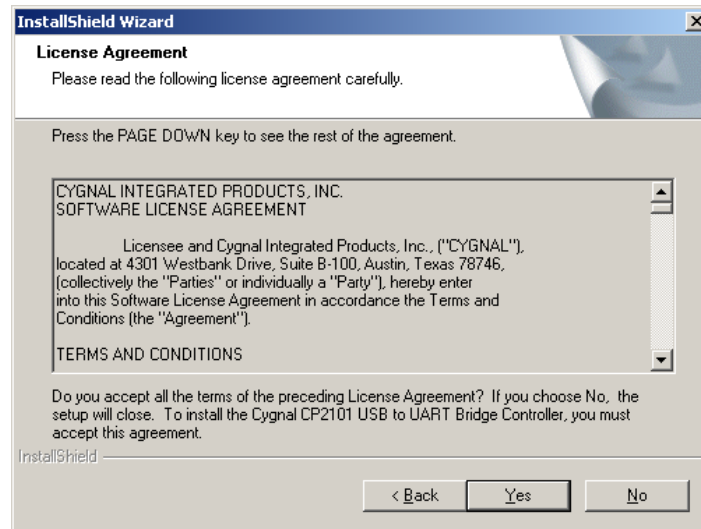

Figure 4: CP2101 USB Driver License Agreement

3. The Destination Location dialog will now be displayed as shown in Figure 5. Select the path to install the decompressed driver setup. The default is **C:\Cygnal\CP2101** and will be used for this installation guide. Once the path has been selected, click the **Next** button.

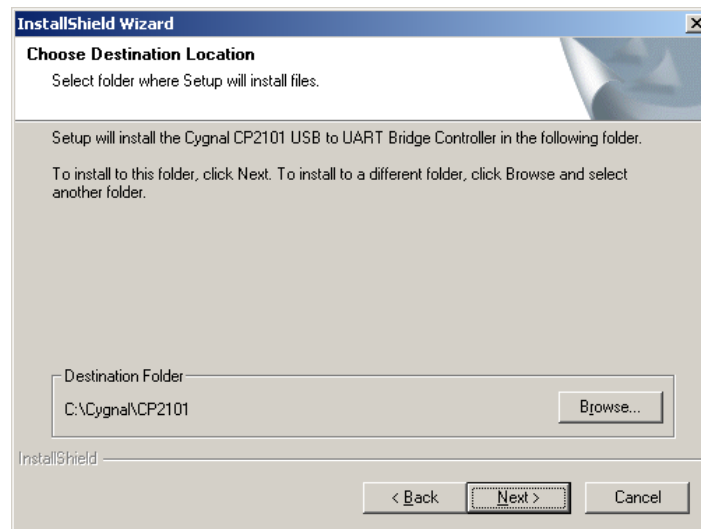

Figure 5: CP2101 USB Driver Destination Path

4. While the driver is being decompressed, the decompression progress will be displayed by a dialog as shown in Figure 6.

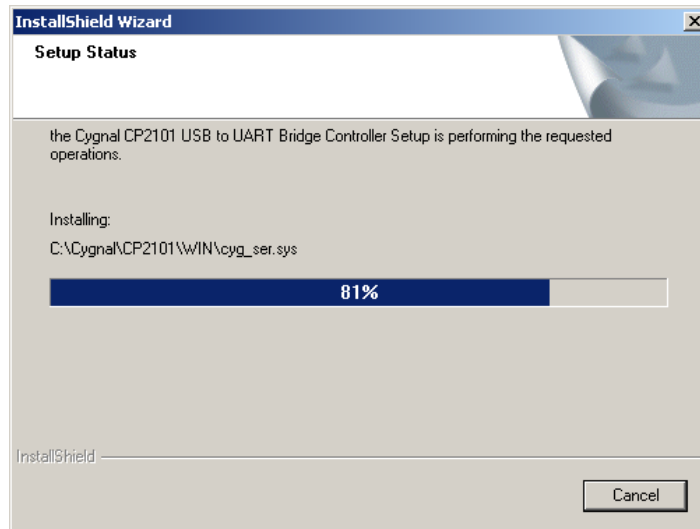

Figure 6: CP2101 USB Driver Setup Progress

5. Once the USB Driver has been decompressed successfully, the screen in Figure 7 will be displayed. Click the **Finish** button.

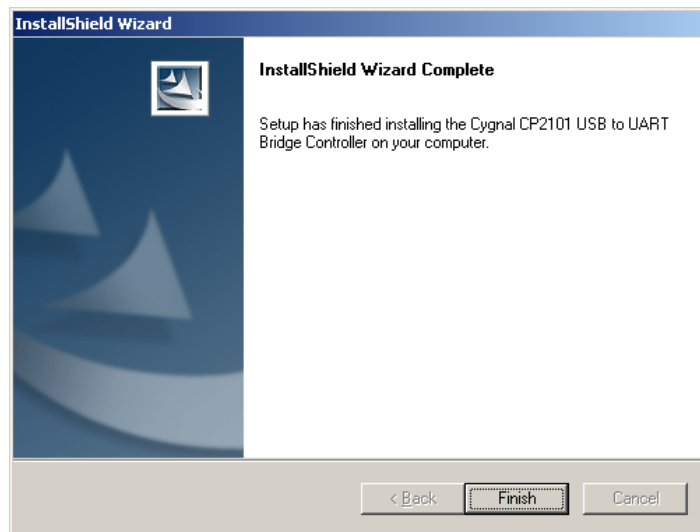

Figure 7: CP2101 USB Driver Installation Complete

Installing the USB Drivers

1. Start the installation of the USB drivers by executing the **Setup.exe** executable file located in the **C:\Cygnal\CP2101\WIN** directory (assuming the default path was used in Step 3).
2. The screen in Figure 8 will be displayed. Select the destination path by clicking the **Browse** button and navigating to the desired target directory. By default the **C:\Program Files\Cygnal\CP2101 USB to UART Bridge Controller** is selected, this guide will use the default path. Once the target path has been selected, click the **Install** button.

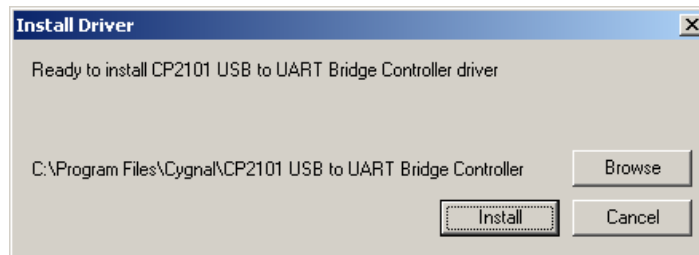

Figure 8: CP2101 USB Driver Installation Dialog

3. Depending upon your computer's configuration, the screen in Figure 9 may appear (more than once). If the dialog appears simply press the **Continue Anyway** button.

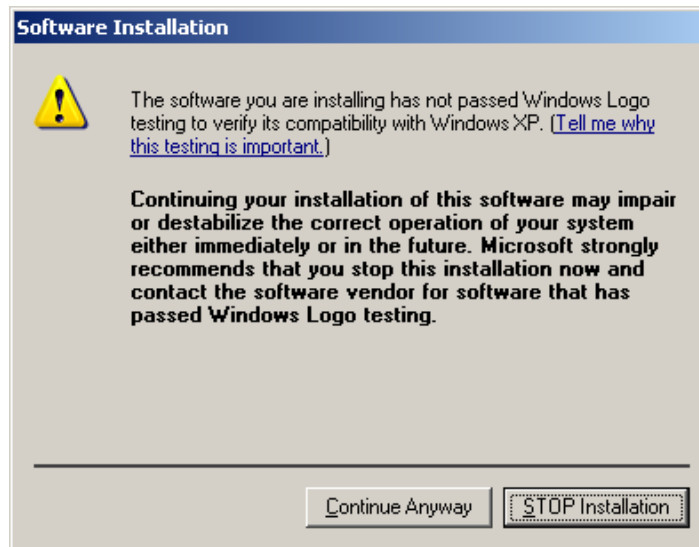

Figure 9: CP2101 USB Driver Windows Logo Testing

4. Once the USB Driver has completed, the dialog in Figure 10 will be displayed. Dismiss the dialog by pressing the **OK** button.

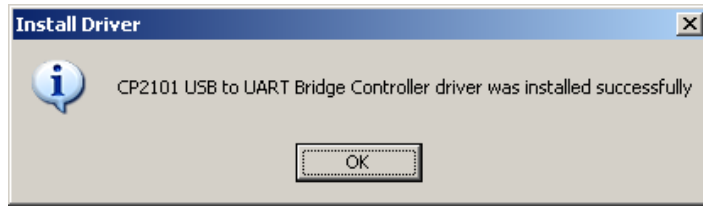

Figure 10: CP2101 USB Driver Installation Complete

Installing the New Hardware on the Computer

1. Once the USB Driver installation has completed, attach the CEL MeshConnect ISP / WNA USB dongle to the computer. The MeshConnect ISP / WNA is powered directly from the USB interface. If it is the first time the MeshConnect ISP / WNA is connected to the computer the dialog, in Figure 11, below will appear.



Figure 11: Windows Found New Hardware (CygnalUSB)

2. Select the ***Install from a list or specific location (Advanced)*** option in the dialog and press the ***Next*** button.

3. The dialog box in Figure 12 will appear. Select the **Don't search. I will choose the driver to install.** option and press the **Next** button.

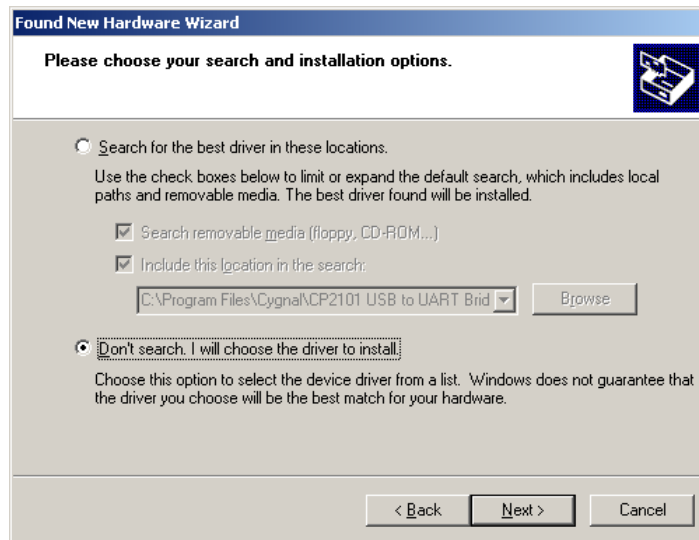

Figure 12: CP2101 USB Driver Installation Options

4. The *Cygnal USB Composite Device* should be displayed in the *Model* window as shown in Figure 13 below. Click the **Next** button and dismiss any Windows Logo Testing dialogs by pressing the **Continue Anyway** button. Should the *Cygnal USB Composite Device* not be listed, click the **Have Disk** button and navigate to the target directory from Step 2 of the previous section (the default path is **C:\Program Files\Cygnal\CP2101 USB to UART Bridge Controller**).

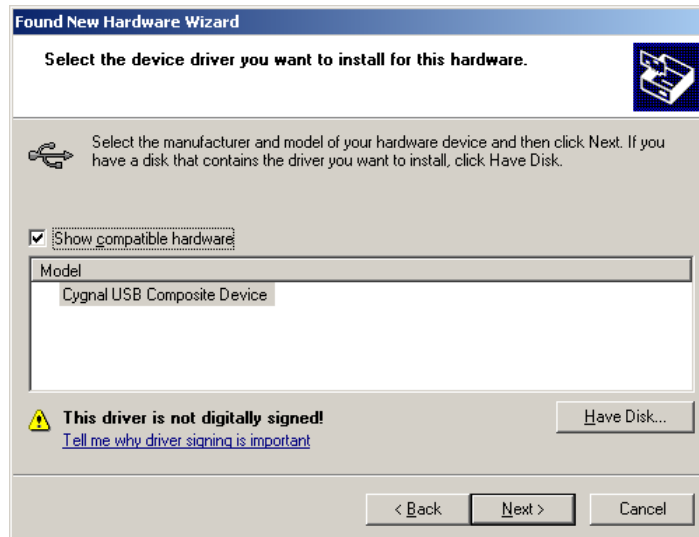

Figure 13: CP2101 USB Driver Selection

5. The driver will begin to installation. Once installation has completed the dialog in Figure 14 will appear. Click the **Finish** button to dismiss the dialog.



Figure 14: CP2101 USB Driver Installation Complete

6. The *Found New Hardware Wizard* dialog box will appear again, this time however it will be installing the driver for the *CP2101 USB to UART Bridge Controller*. Select the ***Install the software automatically (Recommended)*** and press the ***Next*** button.
7. The remaining drivers will automatically be installed. Dismiss any of the *Windows Logo Testing* dialogs by pressing the ***Continue Anyway*** button. Once the drivers have been successfully installed Figure 15 will be displayed. Press the ***Finish*** button to dismiss the dialog box.

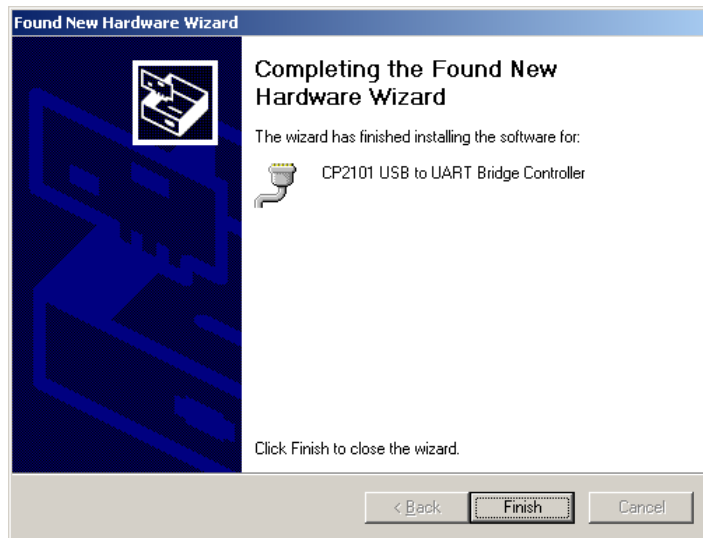

Figure 15: CP2101 USB Driver Installation Complete

Locating the COM Port Assignment

Once the USB driver has been successfully installed a Virtual COM port has been created. In order to interface to the various front-end tools, the COM port assignment is needed. The Windows Device Manager can be used to identify the assigned COM port, as well as verify that the drivers have been properly installed. To determine which COM port has been assigned to the CEL MeshConnect ISP / WNA USB dongle, please follow the steps listed below:

1. Right-click on the **My Computer** icon on your computer's desktop, or the **My Computer** entry from the **Start Menu**.
2. Select **Properties** and the *System Properties* window will be displayed.
3. Click on the **Hardware** tab and then click on the **Device Manager** button. The *Device Manager* will be displayed.
4. Scroll-down and expand the **Ports (COM & LPT)** section. One of the items in the list of available ports should read **CP210x USB to UART Bridge Controller (COM#)**, where # is the assigned COM port. The screenshot shown in Figure 16 has been assigned to COM4.

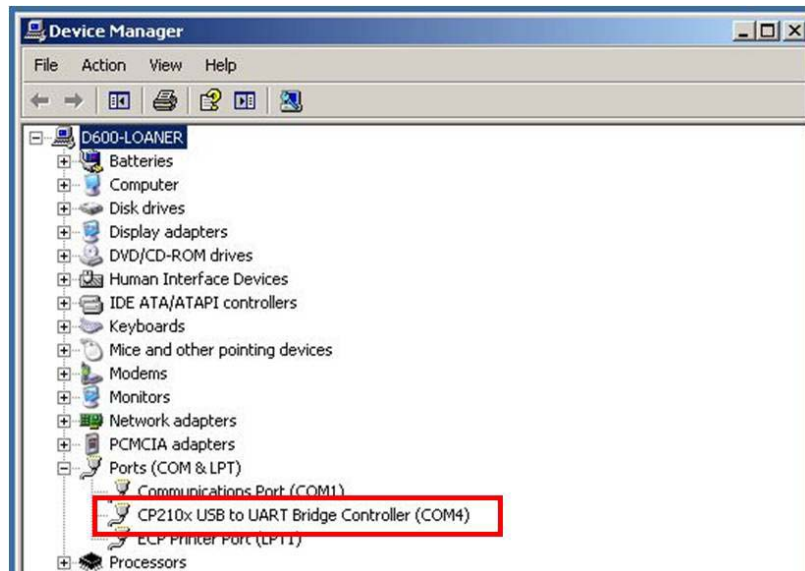

Figure 16: CP2101 COM Port Assignment

5. Make note of the assigned COM port as it will be needed when the CEL MeshConnect ISP / WNA USB dongle is used with the front-end software.

Installing the CEL *Device-Programmer* and *Packet-Analyzer* Software

For installation instructions for the *CEL Device-Programmer* and *CEL Packet-Analyzer* software tools, please refer to their respective User Guides found on the MeshConnect CD-ROM or on the CEL website (<http://www.cel.com>).

CEL MESHCONNECT ISP / WNA FRONT-END SOFTWARE

The CEL MeshConnect ISP / WNA USB dongle is compatible for use in conjunction with the *CEL Device-Programmer* and *CEL Packet-Analyzer* software tools. *CEL Packet-Analyzer v3.32* or later must be used. The latest versions of the tools can be found on the CEL website (<http://www.cel.com>).

Detailed instructions for using the front-end software in conjunction with the CEL MeshConnect ISP / WNA USB dongle can be found in the software tool's respective user guide. The user guides are located on the CD-ROM which shipped with the ISP / WNA or evaluation kit, as well as the CEL website.

HARDWARE

Connecting the CEL MeshConnect ISP / WNA

This section details the connections between the MeshConnect ISP / WNA to the host PC (and the target board, for ISP functionality) for correct operation. Note that the CEL front-end software and the USB drivers must be installed prior. When functioning in ISP-mode, the MeshConnect ISP / WNA dongle must first be connected to the host computer prior to connecting it to the target board.

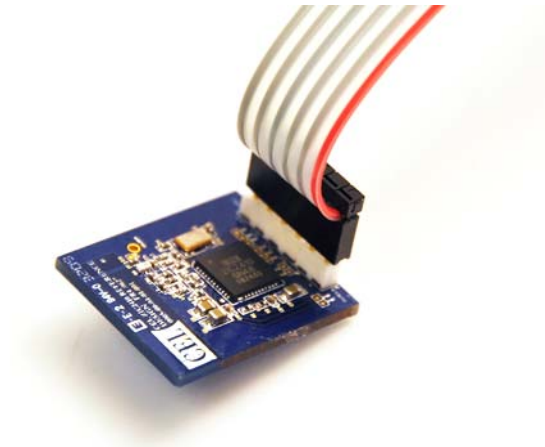

Figure 17: CEL MeshConnect ISP / WNA ISP Target Connection

Hardware Description

The block diagram of the CEL MeshConnect ISP / WNA USB dongle is shown below in Figure 18. The USB dongle is outlined in black hash marks, the ISP functionality is outlined in blue hash marks and the WNA functionality is outlined in solid red.

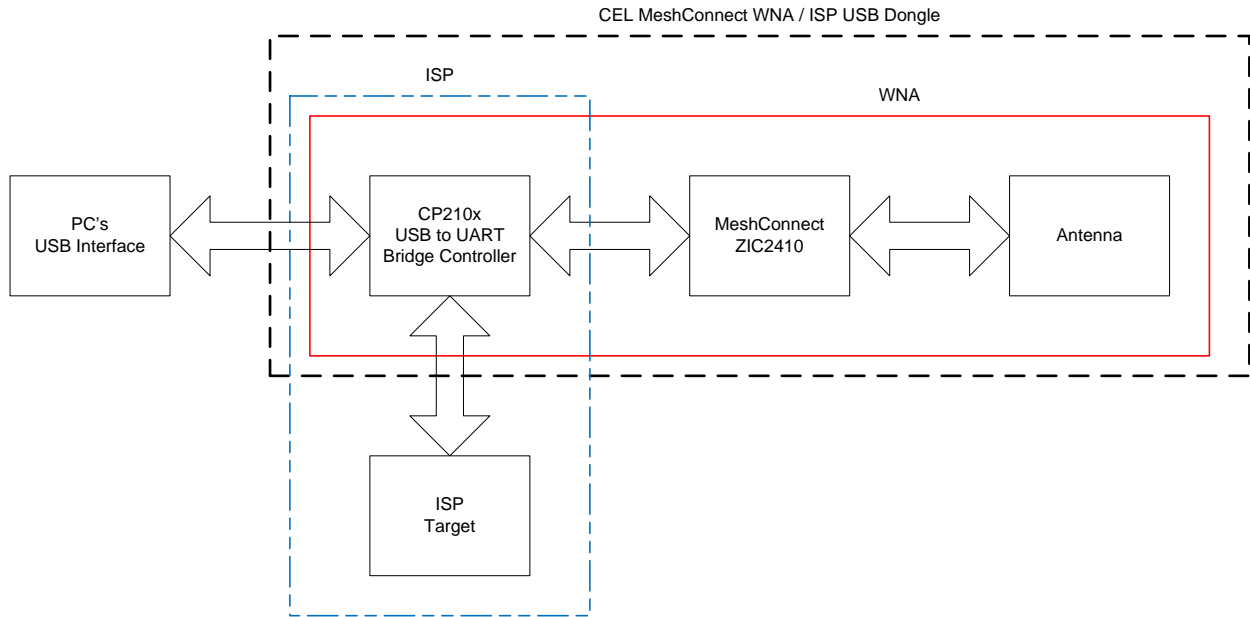

Figure 18: CEL MeshConnect ISP / WNA USB Dongle Block Diagram

CP210x USB to UART Bridge Controller

The USB interface is USB 2.0 compliant (full-speed, 12 Megabits per second). The CEL MeshConnect ISP / WNA USB dongle is powered from the USB port and requires that the host USB port be capable of delivering 200 mA. The output of the CP210x Bridge Controller is a RS-232 compatible signal which will be used to interface to either the on-dongle MeshConnect ZIC2410 IC for WNA functionality or the target system's MeshConnect ZIC2410 IC's UART1 peripheral for In-System Programming.

MeshConnect ZIC2410 and Antenna

When the MeshConnect ISP / WNA USB dongle is operating in WNA-mode, the MeshConnect ZIC2410 in conjunction with the chip antenna is responsible for looking for Simple-MAC, 802.15.4 MAC and ZigBee packets being transmitted. The received packets are then passed to the *CEL Packet-Analyzer* software tool via the CP210x Bridge Controller.

Status LEDs and Switches

The MeshConnect ISP / WNA USB dongle contains 3 status LEDs (Amber, Red and White) and three user-accessible switches (two push-button and one slider). An additional slider switch becomes available

when the user removes the dongle's housing (and is only used when reprogramming the dongle's MeshConnect IC). Table 1 and Table 2 detail the various statuses indicated by the LEDs and the functions of the various switches. Figure 19 and Figure 20 details the locations of the various switches and LEDs of the MeshConnect ISP / WNA.

LABEL	COLOR	DESCRIPTION
Active	Amber	Indicates whether the MeshConnect ISP / WNA received a valid packet (SMAC, MAC or ZigBee) when operating in WNA-mode.
Power	Red	Indicates whether the MeshConnect ISP / WNA is powered. When the RED LED is illuminated, sufficient power has been applied, when off the ISP / WNA is not powered.
ISP	White	Indicates the MeshConnect ISP / WNA operating mode, when the WHITE LED is illuminated the ISP / WNA is in ISP-mode (the MS2 / ISP output of the dongle is '1'), when off the ISP / WNA is in WNA-mode (the MS2 / ISP output of the dongle is '0').

Table 1: Status LED Descriptions

NAME / LABEL	TYPE	DESCRIPTION
(Remote) Reset	Push Button	Toggles the MeshConnect ISP / WNA Remote RESET output when the MeshConnect ISP / WNA is in ISP-mode. When pressed, the target device is placed in RESET.
(Remote) ISP	Push Button	Toggles the MeshConnect ISP / WNA operating mode, when the WHITE LED is illuminated the ISP / WNA is in ISP-mode, when off the ISP / WNA is in WNA-mode.
WNA Reset	SPST Slider	Resets the MeshConnect ISP / WNA USB dongle.
WNA ISP	SPST Slider	When placed in the ISP position, the MeshConnect ISP / WNA USB dongle's firmware can be upgraded. This switch is inaccessible unless the cover of the dongle is physically removed (See the <i>Firmware Upgrade</i> section).

Table 2: Switch Descriptions

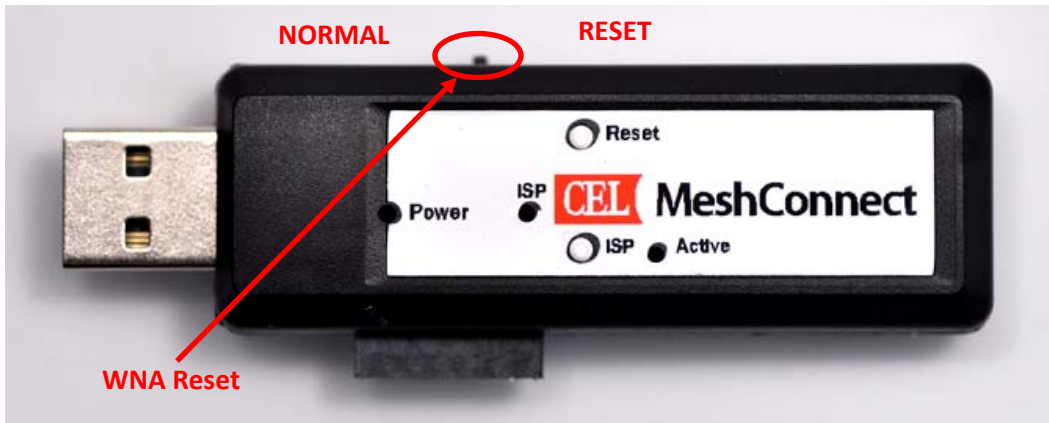

Figure 19: CEL MeshConnect ISP / WNA USB Dongle (Outside)

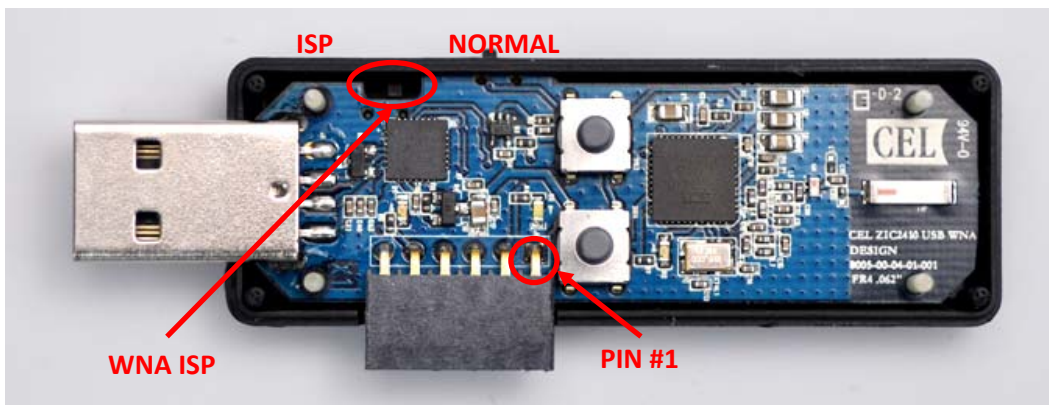

Figure 20: CEL MeshConnect ISP / WNA USB Dongle (Inside)

ISP Target Interface

The target connection interface is configured to supply 3.0 Volts to the target and meant for direct connections to the MeshConnect IC or module pins. Interfacing directly to an RS-232 line driver IC will not work and will most likely damage the MeshConnect ISP / WNA USB dongle. Prior to programming, it is strongly advised that any circuitry on the target board's UART1 or GPIO pins be isolated. Pin #1 on the connector is found on the RED side of the target cable. The target cable has the signal pinout as shown in Figure 20.

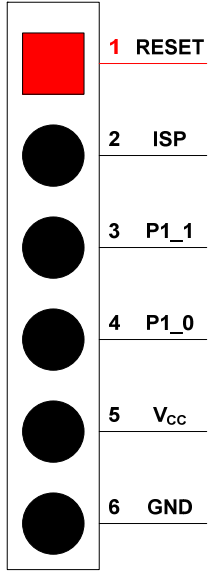

Figure 21: ISP Target Pinout

Example ISP Target Schematic

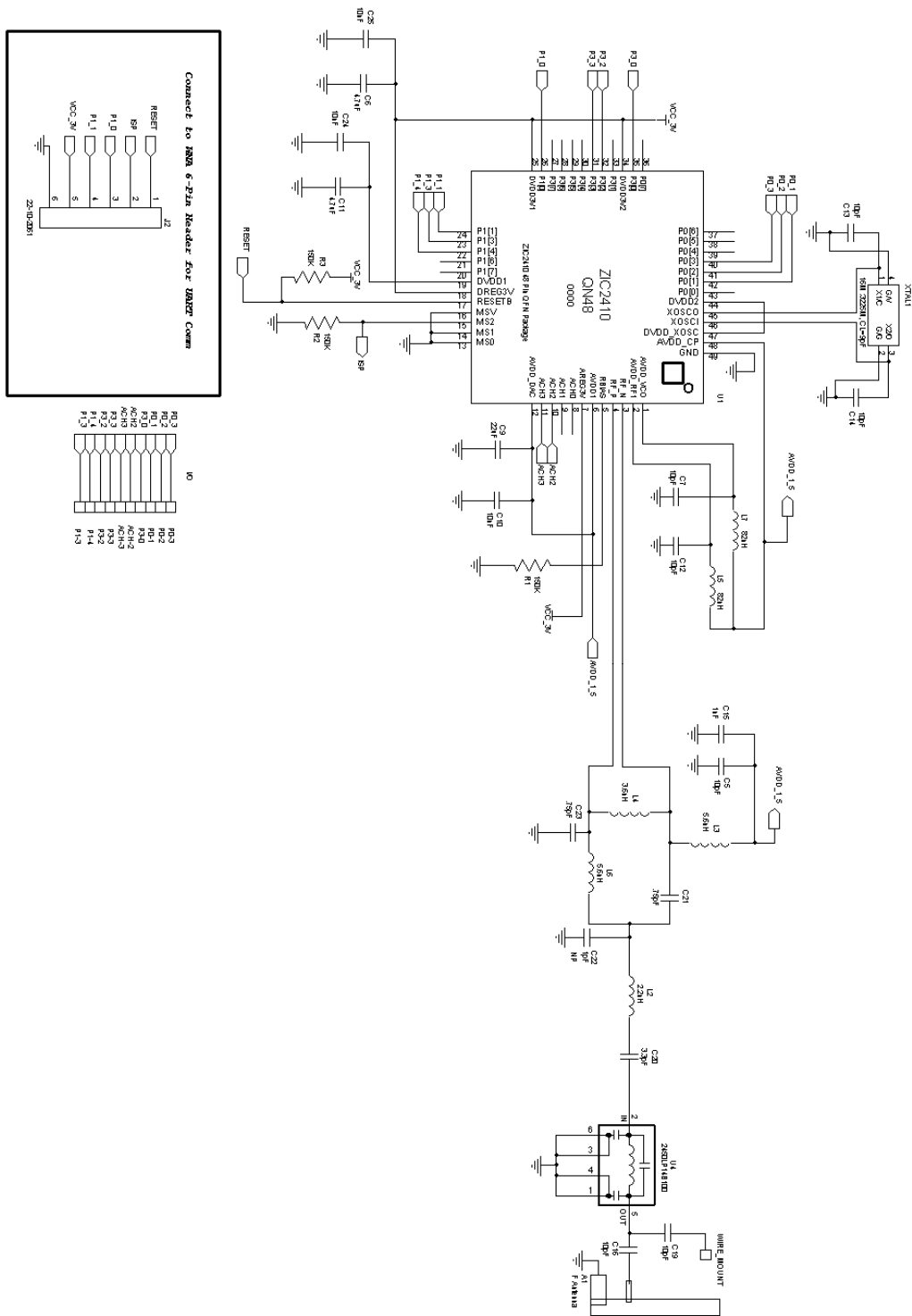

Figure 22: CEL MeshConnect IC Target ISP Schematic

PROGRAMMING THE CEL MESHCONNECT ISP / WNA FIRMWARE

This section details how to re-program the MeshConnect ISP / WNA (either with future revisions of the WNA software, SNAP software, or others). Firmware upgrading of the CEL MeshConnect ISP / WNA USB dongle should not be needed. Should CEL issue new firmware for the WNA the dongle may be re-programmed.

Follow the steps below to manually upgrade (reprogram) the CEL MeshConnect ISP / WNA USB dongle. This procedure should work in all situations.

1. Disconnect (if connected) the target board from the dongle's ISP interface.
2. Unplug the MeshConnect ISP / WNA USB dongle from the PC.
3. Open the MeshConnect ISP / WNA by gently prying the top of the plastic cover from the bottom (be careful not to lose the push-button inserts).
4. Slide the WNA ISP switch to the ISP position (See the *Status LEDs and Switches* section of this document for the switches location).
5. Insert the MeshConnect ISP / WNA USB dongle back into one of the PCs USB ports.
6. Use the *CEL Device-Programmer* software tool to program the firmware onto the USB dongle.
7. When finished, close *Device-Programmer* and remove the MeshConnect ISP / WNA USB dongle from the PC.
8. Slide the WNA ISP switch to the NORMAL position.
9. Replace the cover to the MeshConnect ISP / WNA. The easiest way to replace the cover is to hold the top cover upside-down, re-insert the push-button inserts, then gently place the dongle body into the top cover aligning the pins and squeeze the two pieces together.
10. Insert the MeshConnect ISP / WNA USB dongle into one of the PCs USB ports.
11. Re-connect (if previously connected) the target board to the dongle's ISP interface.

REVISION HISTORY

Revision	Date	Description
A	09Apr2010	Initial Release