

Series 19

Characteristics

The compact 8mm Series 19 is especially suited for:

- Raised design
- PCB (with adaptor)

The low level switching element is laid out for low current applications.

Functions

The Series 19 incorporates the following functions:

- Indicator
- Pushbutton
- Illuminated pushbutton

Market segments

The EAO Series 19 is especially suited for applications in the segments:

- Audio and video
- Laboratory and measuring equipment

Please refer to the EAO website to obtain detailed information regarding this series www.products.eao.com
Configure a product to your exact needs and request a quotation.



Overview**Raised design**

Indicator 4

Illuminated pushbutton 5

Accessories 7**Drawings** 14**Technical data** 15**Application guidelines** 17

Index 18

19 Raised design

Indicator, IP 40



Product can differ from the current configuration.

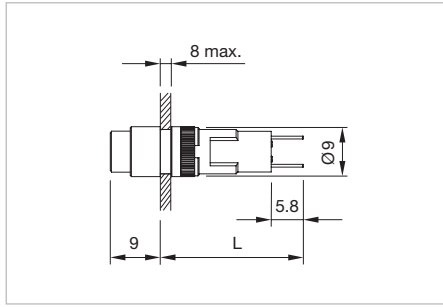

Dimensions [mm]

Additional Information

- For LED element fitting information see «Application guidelines»

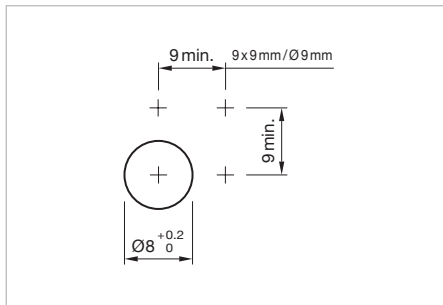

Mounting cut-outs [mm]

Equipment consisting of (schematic overview)



Lens page 7



Single-LED page 10





Actuator



Fixing nut

Each Part Number listed below includes all the black components shown in the 3D-drawing.

To obtain a complete unit, please select the red components from the pages shown.

Behind panel depth	Terminal	Part No.	Component layout	Wiring diagram	Weight
 <p>Indicator actuator, Front dimension 9 x 9 mm</p>					
25 mm	Solder 2.0 x 0.5mm	19-050.005	1	1	0.001 kg
33 mm	Solder 2.0 x 0.5mm	19-051.005	1	1	0.002 kg
 <p>Indicator actuator, Front dimension Ø 9 mm</p>					
25 mm	Solder 2.0 x 0.5mm	19-030.005	1	1	0.001 kg
33 mm	Solder 2.0 x 0.5mm	19-031.005	1	1	0.002 kg

The component layouts you will find from page 14

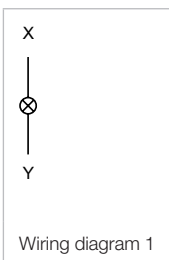

Illuminated pushbutton, IP 40

Equipment consisting of (schematic overview)



Lens page 7



Single-LED page 10

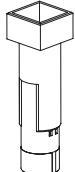

Actuator



Fixing nut

Each Part Number listed below includes all the black components shown in the 3D-drawing.

To obtain a complete unit, please select the red components from the pages shown.



Dimensions



Mounting cut-outs [mm]



Product can differ from the current configuration.

Additional Information

- For LED element fitting information see «Application guidelines»

Switching system	Contacts	Contact material	Switching action	Terminal	Part No.	Component layout	Wiring diagram	Weight
 <p>Illuminated pushbutton actuator, Front dimension 9 x 9 mm</p>								
Low-level element	1 NC	Gold	B	Solder 2.0 x 0.5mm	19-452.035	2	1	0.002 kg
			C	Solder 2.0 x 0.5mm	19-482.035	2	2	0.002 kg
	1 NO	Gold	B	Solder 2.0 x 0.5mm	19-451.035	2	3	0.002 kg
			C	Solder 2.0 x 0.5mm	19-481.035	2	4	0.002 kg
Snap-action switching element	1 NO	Gold	B	Solder 2.0 x 0.5mm	19-159.035	2	3	0.002 kg
			C	Solder 2.0 x 0.5mm	19-289.035	2	4	0.002 kg
		Silver	B	Solder 2.0 x 0.5mm	19-159.015	2	3	0.002 kg
			C	Solder 2.0 x 0.5mm	19-289.015	2	4	0.002 kg
 <p>Illuminated pushbutton actuator, Front dimension Ø 9 mm</p>								
Low-level element	1 NC	Gold	B	Solder 2.0 x 0.5mm	19-432.035	2	1	0.002 kg
			C	Solder 2.0 x 0.5mm	19-472.035	2	2	0.002 kg
	1 NO	Gold	B	Solder 2.0 x 0.5mm	19-431.035	2	3	0.002 kg
			C	Solder 2.0 x 0.5mm	19-471.035	2	4	0.002 kg
Snap-action switching element	1 NO	Gold	B	Solder 2.0 x 0.5mm	19-139.035	2	3	0.002 kg
			C	Solder 2.0 x 0.5mm	19-279.035	2	4	0.002 kg
		Silver	B	Solder 2.0 x 0.5mm	19-139.015	2	3	0.002 kg
			C	Solder 2.0 x 0.5mm	19-279.015	2	4	0.002 kg

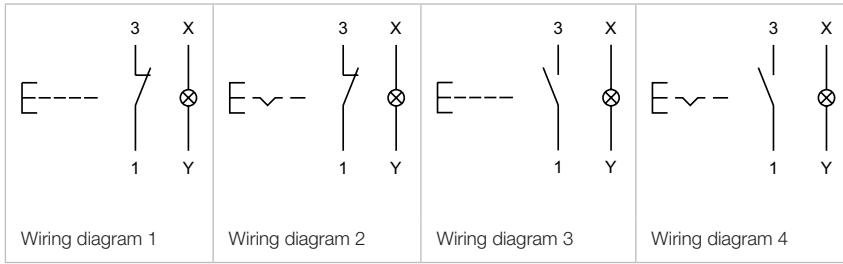

Contacts: NC = Normally closed, NO = Normally open
 Switching action: B = Momentary, C = Maintain
 The component layouts you will find from page 14

19 Raised design



Front

Lens



Product attribute	Dimension	Lens	Part No.	Weight
 <p>Lens</p>				
illuminative, holder translucent	7.3 x 7.3 mm	Plastic red transparent	19-951.2	0.001 kg
		Plastic yellow transparent	19-951.4	0.001 kg
		Plastic green transparent	19-951.5	0.001 kg
		Plastic blue transparent	19-951.6	0.001 kg
		Plastic white transparent	19-951.9	0.001 kg
illuminative, not recommended for film insert, holder transparent	7.3 x 7.3 mm	Plastic red transparent	19-952.2	0.001 kg
		Plastic yellow transparent	19-952.4	0.001 kg
		Plastic green transparent	19-952.5	0.001 kg
		Plastic blue transparent	19-952.6	0.001 kg
		Plastic colourless transparent	19-952.7	0.001 kg
non-illuminative	7.3 x 7.3 mm	Plastic black opaque	19-951.0	0.001 kg
		Plastic grey opaque	19-951.8	0.001 kg
 <p>Lens</p>				
illuminative, holder translucent	Ø 7.3 mm	Plastic red transparent	19-931.2	0.001 kg
		Plastic yellow transparent	19-931.4	0.001 kg
		Plastic green transparent	19-931.5	0.001 kg
		Plastic blue transparent	19-931.6	0.001 kg
		Plastic white transparent	19-931.9	0.001 kg
illuminative, not recommended for film insert, holder transparent	Ø 7.3 mm	Plastic red transparent	19-932.2	0.001 kg
		Plastic yellow transparent	19-932.4	0.001 kg
		Plastic green transparent	19-932.5	0.001 kg
		Plastic blue transparent	19-932.6	0.001 kg
		Plastic colourless transparent	19-932.7	0.001 kg
non-illuminative	Ø 7.3 mm	Plastic black opaque	19-931.0	0.001 kg
		Plastic grey opaque	19-931.8	0.001 kg

19 Accessories

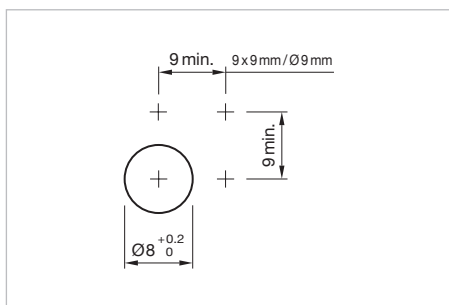
Blind plug



Mounting cut-outs [mm]



Dimension	Mounting cut-out	Material	Colour	Part No.	Weight
 Blind plug					
9 x 9 mm	Ø 8 mm	Plastic	black	19-948.0	0.001 kg
 Blind plug					
Ø 9 mm	Ø 8 mm	Plastic	black	19-949.0	0.001 kg

Rear side



Dimensions [mm]

PCB plug-in base

pins	Terminal	Part No.	Component layout	Weight
 <p>PCB plug-in base</p>				
axial	PCB	19-940	4	0.001 kg
 <p>PCB plug-in base</p>				
right-angled	PCB	19-941	3	0.001 kg

The component layouts you will find from page 14

Flat receptacle

Product attribute	Part No.	Weight
 <p>Flat receptacle</p>		
2.0 x 0.5 mm plug-in terminal	31-945	0.001 kg

Insulation sleeve

Product attribute	Part No.	Weight
 <p>Insulation sleeve</p>		
for flat receptacle 2.0 mm	31-928	0.001 kg

19 Accessories

Illumination

Single-LED, T1 Bi-Pin

Additional Information

- For LED element fitting information see «Application guidelines, LED polarity»
- Luminosity and wave length variations caused by LED manufacturing processes may cause slight differences regarding the illumination

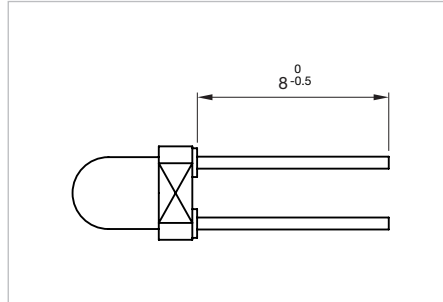

Dimensions [mm]

Pins	LED colour	Lumi. intensity	Dom. wavelength	Forward voltage typ.	Part No.	Weight
 <p>Single-LED</p>						
Single-LED max. length: 8 mm	red	450 mcd	635 nm	2.0 VDC @ 20 mA	10-2601.3172K	0.001 kg
	yellow	450 mcd	587 nm	2.1 VDC @ 20 mA	10-2601.3174K	0.001 kg
	green	1600 mcd	525 nm	3.2 VDC @ 20 mA	10-2603.3175K	0.001 kg
	blue	500 mcd	465 nm	3.2 VDC @ 20 mA	10-2603.3176K	0.001 kg
	white	4600 mcd	x0.31/y0.32 nm	3.0 VDC @ 20 mA	10-2603.3178K	0.001 kg

Single-LED, T1 Bi-Pin

Additional Information

- For LED element fitting information see «Application guidelines»
- Luminosity and wave length variations caused by LED manufacturing processes may cause slight differences regarding the illumination

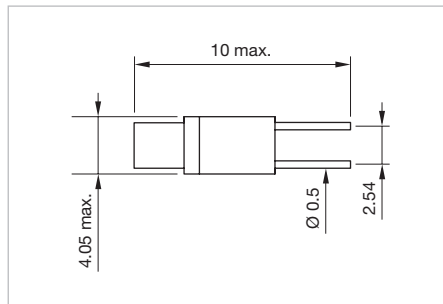

Dimensions [mm]

Pins	LED-colour	Lumi. intensity	Dom. wavelength	Operating voltage	Operation current	Part No.	Weight
 <p>Single-LED</p>							
Single Led T1 Bi-Pin, max. length: 5 mm	red	45 mcd	625 nm	28 VAC/DC +10 %	5 mA/9mA ±15 %	10-2613.1072	0.001 kg
	yellow	270 mcd	580 nm	28 VAC/DC +10 %	5 mA/9mA ±15 %	10-2613.1074	0.001 kg
	green	320 mcd	525 nm	28 VAC/DC +10 %	5 mA/9mA ±15 %	10-2613.1075	0.001 kg

Filament lamp, T1 Bi-Pin

pins	Operating voltage	Operation current	Part No.	Weight
 <p>Filament lamp</p>				
max. length: 5 mm	6 VAC/DC	70 mA	10-1606.1309	0.001 kg
	12 VAC/DC	25 mA	10-1609.1199	0.001 kg
	24 VAC/DC	20 mA	10-1612.1179	0.001 kg

19 Accessories

Mounting

Fixing nut

Dimension	Part No.	Weight
 Fixing nut		
Ø 9/M8 x 13 mm	19-991	0.001 kg

Dressing tool

Additional Information

- For aligning buttons

Part No.	Weight
 Dressing tool	
19-906	0.011 kg

Lens remover

Part No.	Weight
 Lens remover	
19-910	0.002 kg

Lamp remover

Additional Information

▲ **Caution:** A switching process might be released when replacing the lamp

Part No.	Weight
 <p data-bbox="272 624 443 654">Lamp remover</p>	
11-906	0.003 kg

Mounting tool

Additional Information

- For fixing nut long Part No. 19-991

Part No.	Weight
 <p data-bbox="272 1178 437 1207">Mounting tool</p>	
19-905	0.011 kg

19 Drawings

Drawings

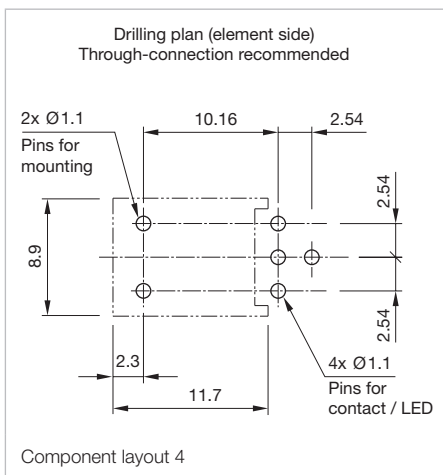
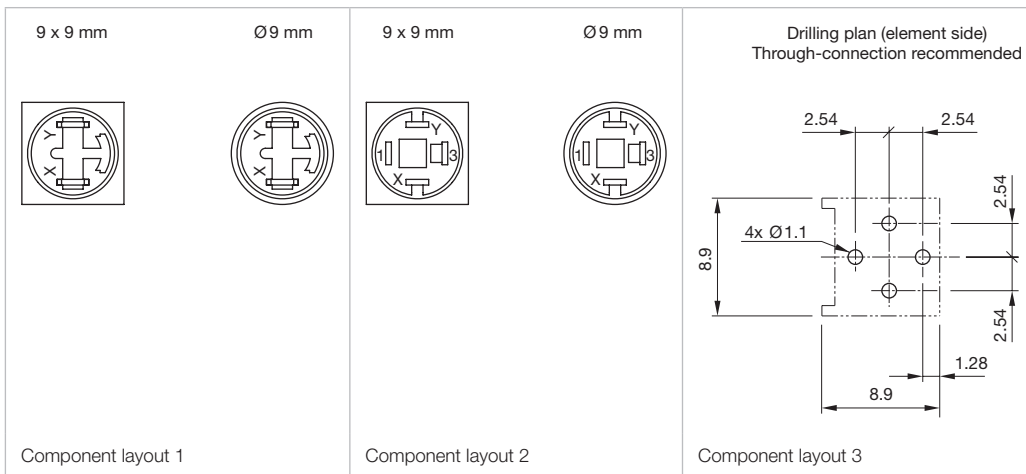

Actuator with snap-action switching element
Switching system

Single-break, snap-action switching system.
1 normally open contact

Material
Material of contact

Gold plated Silver, Silver plated

Switch housing

Polyetherimide (PEI), self-extinguishing

Actuator housing

Polyphenyleneoxide (PPO), self-extinguishing, colour black

Mechanical characteristics
Terminals

Universal terminal:
Max. wire diameter 2 x 0.8 mm
Max. wire cross-section of stranded cable 1 x 0.75 mm²

Plug-in terminal: 2.0 x 0.5 mm

For these terminals we can also supply a plug-in base which, when soldered on to the board, enables the switch to be plugged in.

Tightening torque

for fixing nut max. 20 Ncm

Actuating force

1.6 N

Actuating travel

2.8 mm ±0.2 mm

Mechanical lifetime

2 million operations

Electrical characteristics
Switch rating

Silver plated:
Max. 50 VAC, 0.8 A/72 VDC, 0.7 A
Min. 20 V, 10 mA

Gold plated:
Max. 50 VAC, 100 mA/72 VDC, 70 mA
Min. 100 µV, 50 µA

Electric strength

2500 VAC, 50 Hz, 1 min. between all terminals and earth, as per IEC 60512-2-11

Environmental conditions
Storage temperature

-40 °C ... +85 °C

Service temperature

without illumination -25 °C ... +65 °C
with incandescent lamp -25 °C ... +45 °C
with LED -25 °C ... +65 °C
for indicators and illuminated pushbuttons mounted as a block, make sure the heat can escape freely

Protection degree

IP 40 front side, as per IEC 60529

Actuator with low level switching element
Switching system

This low-level switching system was designed for switching low powers in electronic circuits. The switching system assures reliable switching of loads.

Single-break momentary contact, as normally open or normally closed with 4 independent points of contact.

Special features are the long life, extremely short rebound time and stable contact resistance.

1 normally open or 1 normally closed contact.

Material
Material of contact

Gold plated

Actuator housing

Polyphenyleneoxide (PPO), self-extinguishing, colour black

Mechanical characteristics
Terminals

Universal terminal:
Max. wire diameter 2 x 0.8 mm
Max. wire cross-section of stranded cable 1 x 0.75 mm²

Plug-in terminal: 2.0 x 0.5 mm

For these terminals we can also supply a plug-in base which, when soldered on to the board, enables the switch to be plugged in.

Tightening torque

for fixing nut max. 20 Ncm

Actuating force

1.8 N ±0.3 N

19 Technical data

Actuating travel

2.8mm ±0.2mm

Rebound time

Typ. < 100µs

Mechanical lifetime

5 million operations

Electrical characteristics**Contact resistance**

≤ 50mΩ starting value (initial) as per IEC 60512-2-2b

Switch rating

10µA, 100µV to 100mA at 42VAC/VDC

Electric strength

2500VAC, 50Hz, 1 min. between all terminals and earth, as per IEC 60512-2-11

Environmental conditions**Storage temperature**

-40°C ... +85°C

Service temperature

without illumination -25°C ... +65°C

with incandescent lamp -25°C ... +45°C

with LED -25°C ... +65°C

for indicators and illuminated pushbuttons mounted as a block, make sure the heat can escape freely

Protection degree

IP 40 front side, as per IEC 60529

Shock resistance

(Single impacts, semi-sinusoidal)

15g for 11ms, as per IEC 60512-4-3, IEC 60068-2-27

EAO reserves the right to alter specifications without further notice.

Suppressor circuits

When switching inductive loads such as relays, DC motors, and DC solenoids, it is always important to absorb surges (e.g. with a diode) to protect the contacts. When these inductive loads are switched off, a counter emf can severely damage switch contacts and greatly shorten lifetime.

Fig. 1 shows an inductive load with a free-wheeling diode connected in parallel. This free-wheeling diode provides a path for the inductor current to flow when the current is interrupted by the switch. Without this free-wheeling diode, the voltage across the coil will be limited only by dielectric breakdown voltages of the circuit or parasitic elements of the coil. This voltage can be kilovolts in amplitude even when nominal circuit voltages are low (e.g. 12VDC) see Fig. 2.

The free-wheeling diode should be chosen so that the reverse breakdown voltage is greater than the voltage driving the inductive load. The DC blocking voltage (V_R) of the free-wheeling diode can be found in the datasheet of a diode. The forward current should be equal or greater than the maximum current flowing through the load.

To get an efficient protection, the free-wheeling diode must be connected as close as possible to the inductive load!

Switching with inductive load
Fig. 1

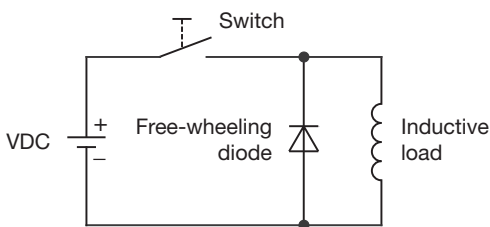

Counter EMF
over load without free-wheeling diode
Fig. 2

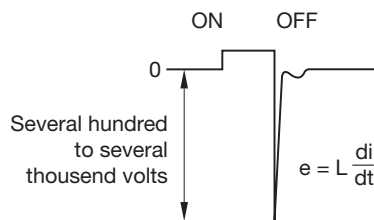

LED polarity

When fitting the LED elements the polarity has to correspond with the respective terminal, (x+) goes to +.

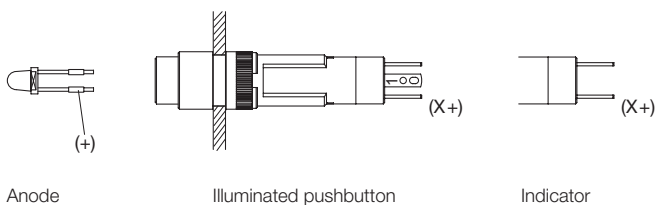

Recommended LED series resistors for optimum illumination

Resistor size 0207.1 %

	LED red	LED yellow	LED green	LED white	LED blue
6 VDC	390R	390R	1K5	390R	390R
12 VDC	1K	1K	4K7	1K	1K
24 VDC	2K2	2K2	10K	2K2	2K2

Part No.	Page
10-1606.1309	11
10-1609.1199	11
10-1612.1179	11
10-2601.3172K.....	10
10-2601.3174K.....	10
10-2603.3175K.....	10
10-2603.3176K.....	10
10-2603.3178K.....	10
10-2613.1072	10
10-2613.1074	10
10-2613.1075	10
11-906	13
19-030.005	4
19-031.005	4
19-050.005	4
19-051.005	4
19-139.015	5
19-139.035	5
19-159.015	5
19-159.035	5
19-279.015	5
19-279.035	5
19-289.015	5
19-289.035	5
19-431.035	5
19-432.035	5
19-451.035	5
19-452.035	5
19-471.035	5
19-472.035	5
19-481.035	5
19-482.035	5
19-905	13
19-906	12
19-910	12
19-931.0	7
19-931.2	7
19-931.4	7
19-931.5	7
19-931.6	7
19-931.8	7
19-931.9	7
19-932.2	7
19-932.4	7
19-932.5	7
19-932.6	7
19-932.7	7
19-940	9
19-941	9
19-948.0	8
19-949.0	8
19-951.0	7
19-951.2	7
19-951.4	7
19-951.5	7
19-951.6	7
19-951.8	7
19-951.9	7
19-952.2	7
19-952.4	7
19-952.5	7
19-952.6	7
19-952.7	7
19-991	12
31-928	9
31-945	9