

FEATURES

- **High-Reliability Cermet Resistors**
- **Space Saving Over Individual Resistors**
- **Low Profile**
- Available in Odd or Even Number of Pins From 4 to 12 Leads
- 0.100 inch [2.54 mm] Pin Spacing
- Resistance Range 22Ω to 1 MΩ (E-24 Series)
- Temperature Coefficient of Resistance (T.C.R.) ±100ppm/°C
- Operating Temperature to -55°C to +125°C
- Epoxy Resin Coating
- Bulk Packaging
- **RoHS Compliant in Accordance with EU Directive 2005/95/EC**
 - Lead-Free Termination Finish
 - Exemption 5 for Pb in glass material and resistor elements

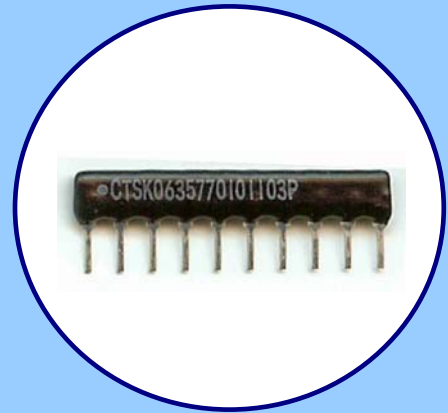

ORDERING INFORMATION

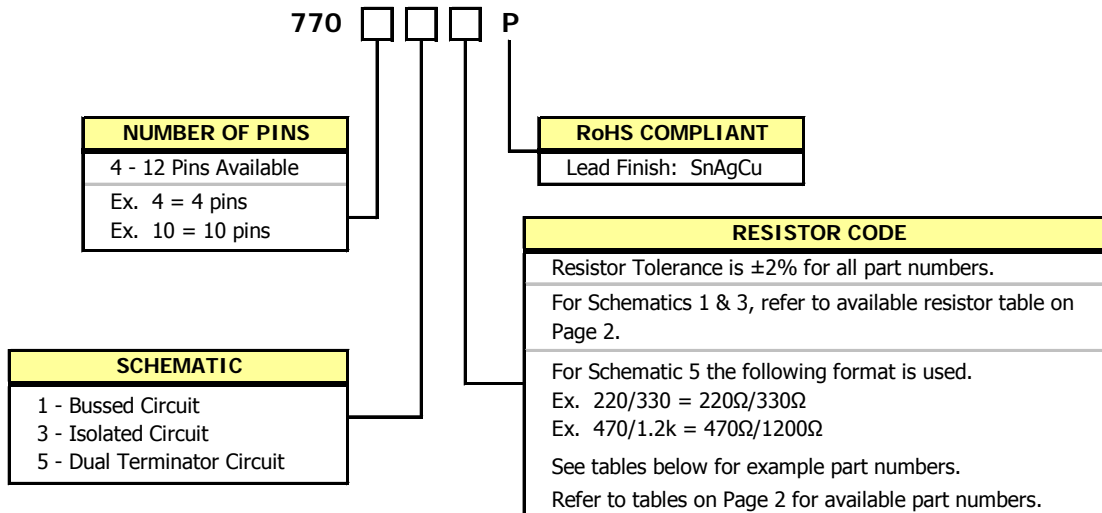

Not all pin count, schematic combinations and resistor values may be available. Contact your local CTS Representative or CTS Customer Service for availability.

Schematic 5 Example Part Numbers

For R1 and R2 <1k Ohms			
R1 (ohms)	R2 (ohms)	R1/R2	Part Number
81	130	81/130	77010581/130P
100	200	100/200	770105100/200P
180	270	180/270	770105180/270P
220	330	220/330	770105220/330P

Schematic 5 Example Part Numbers

For R1 or R2 >1k Ohms			
R1 (ohms)	R2 (ohms)	R1/R2	Part Number
470	1k	470/1k	770105470/1KP
750	2.3k	750/2.3k	770105750/2.3KP
1k	2k	1k/2k	7701051K/2KP
1.1k	2.2k	1.1k/2.2k	7701051.1/2.2KP *
1.5k	3.3K	1.5k/3.3k	7701051.5/3.3KP *

* CTS Part Number limited to 15 characters maximum. First k is omitted

ORDERING INFORMATION

AVAILABLE RESISTOR VALUES & EIA CODE (E-24 Series)

Ohms	Code	Ohms	Code	Ohms	Code	Ohms	Code	Ohms	Code	Ohms	Code	Ohms	Code	Ohms	Code	Ohms	Code	Ohms	Code
22	220	68	680	220	221	680	681	2.2K	222	6.8K	682	22.0K	223	68.0K	683	220K	224	680K	684
24	240	75	750	240	241	750	751	2.4K	242	7.5K	752	24.0K	243	75.0K	753	240K	244	750K	754
27	270	82	820	270	271	820	821	2.7K	272	8.2K	822	27.0K	273	82.0K	823	270K	274	820K	824
30	300	91	910	300	301	910	911	3.0K	302	9.1K	912	30.0K	303	91.0K	913	300K	304	910K	914
33	330	100	101	330	331	1.0K	102	3.3K	332	10.0K	103	33.0K	333	100K	104	330K	334	1M	105
36	360	110	111	360	361	1.1K	112	3.6K	362	11.0K	113	36.0K	363	110K	114	360K	364		
39	390	120	121	390	391	1.2K	122	3.9K	392	12.0K	123	39.0K	393	120K	124	390K	394		
43	430	130	131	430	431	1.3K	132	4.3K	432	13.0K	133	43.0K	433	130K	134	430K	434		
47	470	150	151	470	471	1.5K	152	4.7K	472	15.0K	153	47.0K	473	150K	154	470K	474		
51	510	160	161	510	511	1.6K	162	5.1K	512	16.0K	163	51.0K	513	160K	164	510K	514		
56	560	180	181	560	561	1.8K	182	5.6K	562	18.0K	183	56.0K	563	180K	184	560K	564		
62	620	200	201	620	621	2.0K	202	6.2K	622	20.0K	203	62.0K	623	200K	204	620K	624		

SCHEMATIC 5, AVAILABE PART NUMBERS

Model 770105			
For R1 and R2 <1k			
R1 (ohms)	R2 (ohms)	R1/R2	Part Number
81	130	81/130	77010581/130P
100	200	100/200	770105100/200P
100	150	100/150	770105100/150P
100	430	100/430	770105100/430P
106	169	106/169	770105106/169P
120	180	120/180	770105120/180P
121	195	121/195	770105121/195P
160	240	160/240	770105160/240P
162	260	162/260	770105162/260P
180	220	180/220	770105180/220P
180	270	180/270	770105180/270P
180	300	180/300	770105180/300P
180	390	180/390	770105180/390P
220	270	220/270	770105220/270P
220	330	220/330	770105220/330P
250	250	250/250	770105250/250P
270	470	270/470	770105270/470P
330	330	330/330	770105330/330P
330	390	330/390	770105330/390P
330	470	330/470	770105330/470P
360	720	360/720	770105360/720P
390	620	390/620	770105390/620P
470	680	470/680	770105470/680P
750	750	750/750	770105750/750P

Model 770105			
For R1 or R2 >1k			
R1 (ohms)	R2 (ohms)	R1/R2	Part Number
470	1K	470/1K	770105470/1KP
560	1K	560/1K	770105560/1KP
750	2.3K	750/2.3K	770105750/2.3KP
1K	2K	1K/2K	7701051K/2KP
1.1K	2.2K	1.1K/2.2K	7701051.1/2.2KP
1K	3.3K	1K/3.3K	7701051K/3.3KP
1.5K	1.5K	1.5K/1.5K	7701051.5/1.5KP
1.5K	3.3K	1.5K/3.3K	7701051.5/3.3KP
2.2K	4.4K	2.2K/4.4K	7701052.2/4.4KP
2.2K	5.6K	2.2K/5.6K	7701052.2/5.6KP
3K	6.2K	3K/6.2K	7701053K/6.2KP
3.3K	4.7K	3.3K/4.7K	7701053.3/4.7KP
3.9K	3.3K	3.9K/3.3K	7701053.9/3.3KP
5K	5K	5K/5K	7701055K/5KP
22K	56K	22K/56K	77010522K/56KP

First K is omitted

PACKAGING INFORMATION

Standard packaging is bulk in bag. Device quantity is 250 pieces per bag.

ELECTRICAL CHARACTERISTICS

PRODUCT CHARACTERISTICS

CIRCUIT SCHEMATIC	PIN COUNT	POWER RATING SINGLE RESISTOR ELEMENT		T.C.R. MAXIMUM	RESISTANCE RANGE	RESISTANCE TOLERANCE	MAXIMUM WORKING VOLTAGE	MAXIMUM OVERLOAD VOLTAGE	RATED AMBIENT TEMPERATURE	OPERATING TEMPERATURE RANGE
		@ +25°C	@ +70°C							
1 - Bussed	4 - 12	150mW ¹	100mW	±100ppm/°C	22 - 1M (E24) ²	±2%	E = $\sqrt{P \cdot R}$ or 50, whichever is less ³	E = $(\sqrt{P \cdot R}) \cdot 2.5$ or 100, whichever is less ³	+25°C	-55°C to +125°C
3 - Isolated	4 - 12	@ +25°C	@ +70°C		Note 3					
5 - Dual Terminator	6, 8, 10									

Notes:

- Power rating is based on continuous full load operation at an ambient temperature of +25°C.
For resistors operated at ambient temperatures above +25°C, power rating shall be derated per the Derating Curve below.
- Except Part Number 77083120P (12 ohms).
- See Page 2 for Schematic 5 available part numbers.
- P = Power Rating, R = Resistance.

PACKAGE POWER RATINGS

PIN COUNT	PACKAGE POWER @ +25°C	PACKAGE POWER @ +70°C
4	500mW	300mW
5	700mW	400mW
6	800mW	500mW
7	900mW	600mW
8	1.10W	700mW
9	1.20W	800mW
10	1.40W	900mW
11	1.50W	1.00W
12	1.60W	1.10W

PACKAGE POWER DERATING CURVE

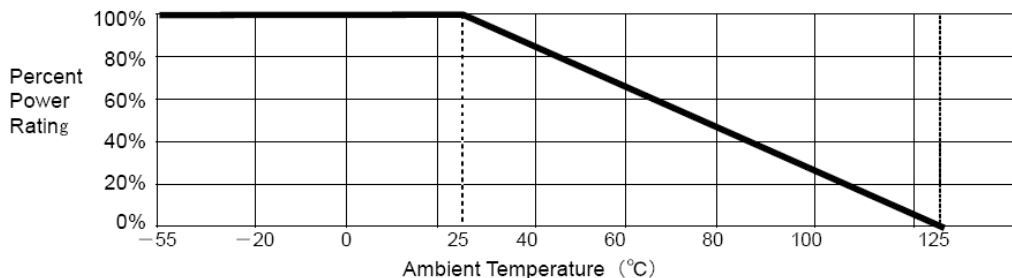

CIRCUIT SCHEMATICS

(1) BUSSED

Available in 4 to 12 pin configurations.

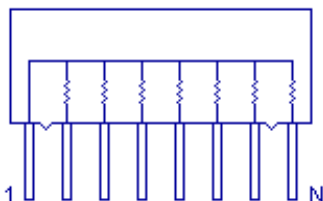

(3) ISOLATED

Available in 4, 6, 8, 10, 12 pin configurations.

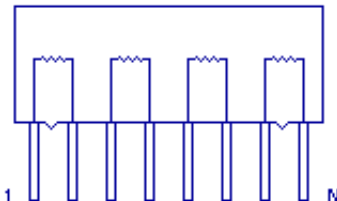

(5) DUAL TERMINATOR

Available in 6, 8, 10 pin configurations.

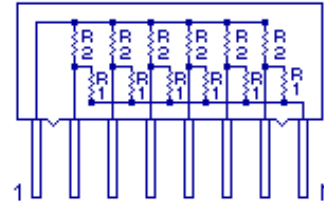

ENVIRONMENTAL SPECIFICATIONS

TEST	DELTA RESISTANCE		TEST CONDITION	
	TYPICAL	LIMIT		
Temperature Cycling	±0.25%	±0.5%	-40°C (30 minutes), +85°C (30 minutes), 5 cycles	
Short Time Overload	±0.25%	±0.5%	2.5 times rated voltage, 5 seconds (100V maximum)	
Moisture Resistance	R ≤ 100Ω R > 100Ω	±1.00% ±2.00%	+40°C ±2°C, 90%/95% R.H., 1000 hours	
Temperature Coefficient (T.C.R.)		±100ppm/°C	+25°C/-55°C, +25°C/+125°C	
Life at Elevated Temperature		±3.00%	+125°C, 1000 hours, no load	
Load Life	R ≤ 100Ω R > 100Ω	±1.00% ±2.00%	+70°C ±2°C, 1000 hours, rated load	
Insulation Resistance		10G Ω min.	200V	
Dielectric Strength	±0.25%	±0.5%	200V	
Terminal Strength	Lead Pull	±0.25%	±0.5%	9.8N pull 10 seconds
	Lead Bend	three 45° bends		2.45N
Resistance to Solder Heat	±0.25%	±0.5%	+260°C ±5°C, 10 seconds ±1 second	
Solderability			RMA Flux, +230°C, 5 seconds dip, 95% coverage	
Mechanical Shock	±0.25%	±0.5%	100g, 1 msec., 3 shocks each plane	
Vibration	±0.25%	±0.5%	20g, 10-2000Hz, 4 hours/plane	
Flammability			Conforms to UL94V-0	
Non-Fungus per MIL-STD 810C				
Resistance to Solvents			Isopropyl alcohol	

MECHANICAL SPECIFICATIONS

PACKAGE DRAWING

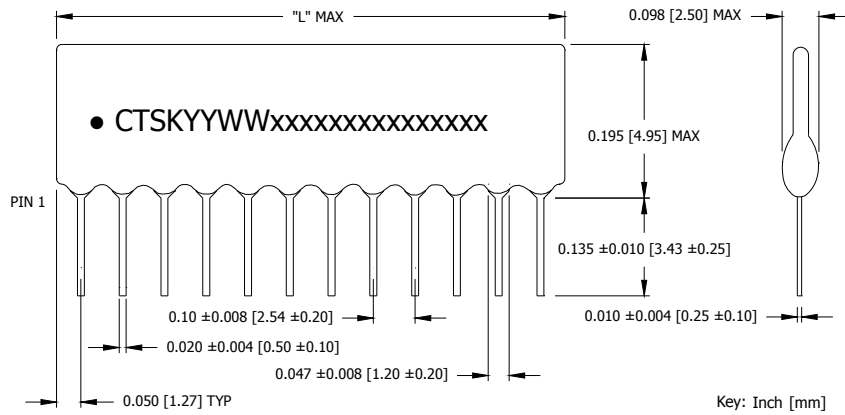

MARKING INFORMATION

1. ● – Pin 1 identifier.
2. CTSK – CTS identifier.
4. YYWW – Date code, YY – year, WW – week.
5. xxxxxxxxxxxxxx – Reserved for CTS part number, Ex. 77083472P.

For parts with reduced marking (8 pins or less), the part series 770 may be omitted from the part number portion of the marking code.
Ex. CTSK434729

Complete CTS part number and date code information must appear on reel and carton labels.

NOTES

1. Copper (Cu) plated iron (Fe) leads.
2. Termination finish (e1); tin (Sn) silver (Ag) copper (Cu).
3. Reflow conditions per JEDEC J-STD-020, +260°C maximum.

PACKAGE LENGTHS

PIN COUNT	"L" MAXIMUM Inch [mm]
4	0.40 [10.16]
5	0.50 [12.70]
6	0.60 [15.24]
7	0.70 [17.78]
8	0.80 [20.32]
9	0.90 [22.86]
10	1.00 [25.40]
11	1.10 [27.94]
12	1.20 [30.48]