

DDR SDRAM TERMINATOR TECHNICAL DATA SHEET

FEATURES

- 18 Bit SSTL_2 Termination Sets
- Compliant to JEDEC Standard 8-9A
- Excellent High Frequency Performance
- Slim BGA Package
- 1% Resistor Tolerance
- Low Channel Capacitance
- Tape and Reel Packaging
- RoHS Compliant Designs Available
 - Compatible with both lead and lead-free manufacturing processes
- **RoHS Compliant in Accordance with EU Directive 2011/65/EU**
 - Lead-Free Termination Finish
 - Exemption 7(c)-1, Electrical and electronic components containing lead [Pb] in glass

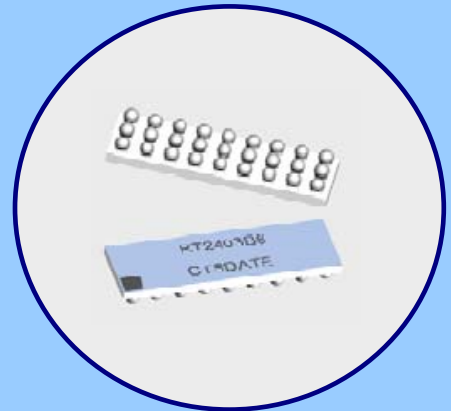

DESCRIPTION

This SSTL_2 terminator network provides high performance resistor termination for SSTL_2 Class I or Class II systems. Designed with a ceramic substrate, this device minimizes channel capacitance, a primary cause of reduced system performance. In addition, the BGA package eases routing design, saving the designer many hours of printed circuit layout. The BGA packaging has been proved to reduce rework and improve reliability.

ORDERING INFORMATION

1.27mm PITCH NON-RoHS PART NUMBER	1.00mm PITCH NON-RoHS PART NUMBER	CIRCUIT STYLE	R1 [Ohms]	R2 [Ohms]	ARRAY SIZE	1.27mm PITCH RoHS PART NUMBER	1.00mm PITCH RoHS PART NUMBER
RT1400B6 *	RT1400B7 *	H	50	25	3 x 9	RT2400B6 *	RT2400B7 *
RT1401B6	RT1401B7	H	25	22	3 x 9	RT2401B6	RT2401B7
RT1402B6 *	RT1402B7 *	F	50	-	3 x 9	RT2402B6 *	RT2402B7 *
RT1403B6 *	RT1403B7 *	F	25	-	3 x 9	RT2403B6 *	RT2403B7 *
RT1404B6 *	RT1404B7 *	C	25	-	4 x 9	RT2404B6 *	RT2404B7 *
RT1405B6 *	RT1405B7 *	C	22	-	4 x 9	RT2405B6 *	RT2405B7 *
RT1407B6 *	RT1407B7 *	F	35	-	3 x 9	RT2407B6 *	RT2407B7 *
RT1408B6 *	RT1408B7 *	H	60	25	3 x 9	RT2408B6 *	RT2408B7 *
RT1409B6	RT1409B7	C	120	-	4 x 9	RT2409B6	RT2409B7
RT1410B6	RT1410B7	F	100,000	-	3 x 9	RT2410B6	RT2410B7
RT1430B6	RT1430B7	F	60	-	3 x 9	RT2430B6	RT2430B7
RT1432B6	RT1432B7	F	120	-	3 x 9	RT2432B6	RT2432B7
RT1460B6	RT1460B7	C	50	-	4 x 9	RT2460B6	RT2460B7
RT1463B6 *	RT1463B7	C	33	-	4 x 9	RT2463B6 *	RT2463B7
RT1465B6	RT1465B7	C	47	-	4 x 9	RT2465B6	RT2465B7
RT1467B6 *	RT1467B7 *	F	75	-	3 x 9	RT2467B6 *	RT2467B7 *
RT1468B6 *	RT1468B7 *	F	150	-	3 x 9	RT2468B6 *	RT2468B7 *

* Indicates available Top Probe-able part numbers.

Refer to the following link for detailed Top Side Probe-able information: www.ctscorp.com/components/clearone/TopProveClearOne.pdf

TAPE & REEL INFORMATION

SUFFIX	TR7	TR13
Tape Width	24mm	24mm
Carrier Pitch	8mm	8mm
Reel Diameter	7inch	13inch
Parts/Reel	1,000	4,000

Part Number Coding

For 7inch reel, add TR7 to part number

Ex. RT2400B6TR7

For 13inch reel, add TR13 to part number

Ex. RT2400B6TR13

(Bulk packaging is not available)

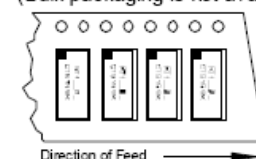

ELECTRICAL & ENVIRONMENTAL CHARACTERISTICS

Resistor Tolerance	±1%
TCR	±200ppm/°C
Operating Temperature Range	-55°C to +125°C
Maximum Resistor Power	0.05 Watts at 70°C
Maximum Package Power	1.0 Watts at 70°C
Process Requirements	
Maximum Re-flow Temperature	Per IPC/JEDEC J-STD-020C

CIRCUIT TYPES

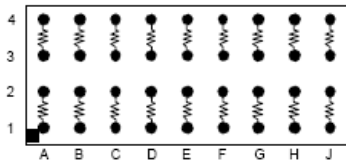

Style C

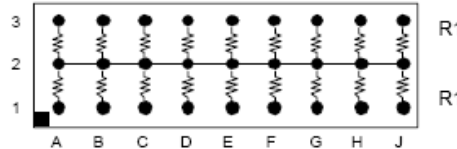

Style F

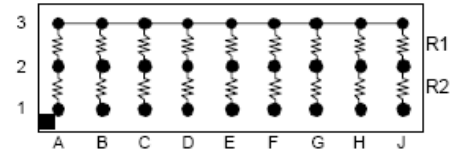

Style H

PACKAGE OUTLINES

1.27mm PITCH		L	W	H	P	D	K
Styles H & F	mm	11.43 ±0.15	3.81 ±0.15	1.32 ±0.15	1.27 ±0.25	0.76 ±0.05	0.64 ±0.25
	inch	0.450 ±0.006	0.150 ±0.006	0.052 ±0.006	0.050 ±0.010	0.030 ±0.002	0.025 ±0.010
1.00mm PITCH		L	W	H	P	D	K
Styles H & F	mm	9.00 ±0.15	3.00 ±0.15	1.19 ±0.15	1.00 ±0.25	0.64 ±0.05	0.50 ±0.25
	inch	0.354 ±0.006	0.118 ±0.006	0.047 ±0.006	0.039 ±0.010	0.025 ±0.002	0.020 ±0.010

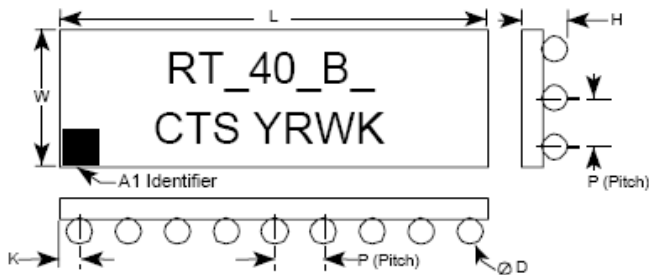

1.27mm PITCH		L	W	H	P	D	K
Style C	mm	11.43 ±0.15	5.08 ±0.15	1.32 ±0.15	1.27 ±0.25	0.76 ±0.05	0.64 ±0.25
	inch	0.450 ±0.006	0.200 ±0.006	0.052 ±0.006	0.050 ±0.010	0.030 ±0.002	0.025 ±0.010
1.00mm PITCH		L	W	H	P	D	K
Style C	mm	9.00 ±0.15	4.00 ±0.15	1.19 ±0.15	1.00 ±0.25	0.64 ±0.05	0.50 ±0.25
	inch	0.354 ±0.006	0.157 ±0.006	0.047 ±0.006	0.039 ±0.010	0.025 ±0.002	0.020 ±0.010

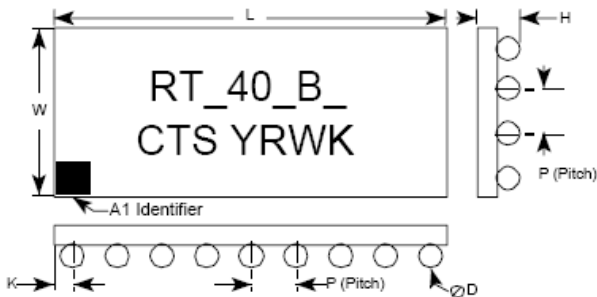

PACKAGE OUTLINES

LAND PATTERNS

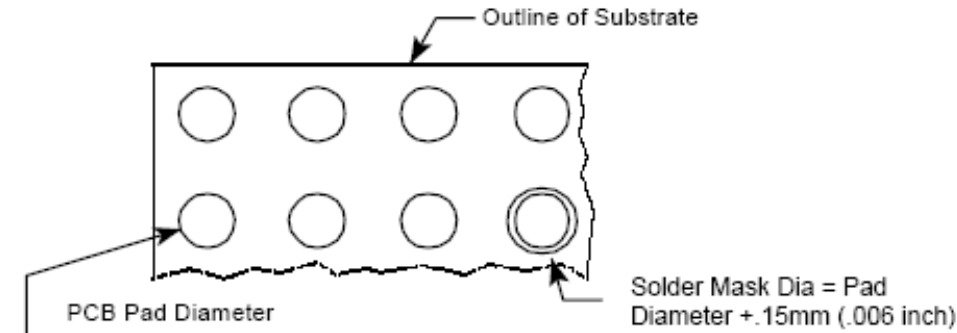

- 1.00mm Pitch (B7) = 0.51mm/.020 inch (minimum)
- 1.27mm pitch (B6) = 0.64mm/.025 inch (minimum)

For .006" Thick Solder Paste Stencil, Aperture Opening Should be Equal to the PCB Pad Diameter.

Refer to www.ctscorp.com/components/clearone.asp for additional PCB design information

BGA Routing Schemes

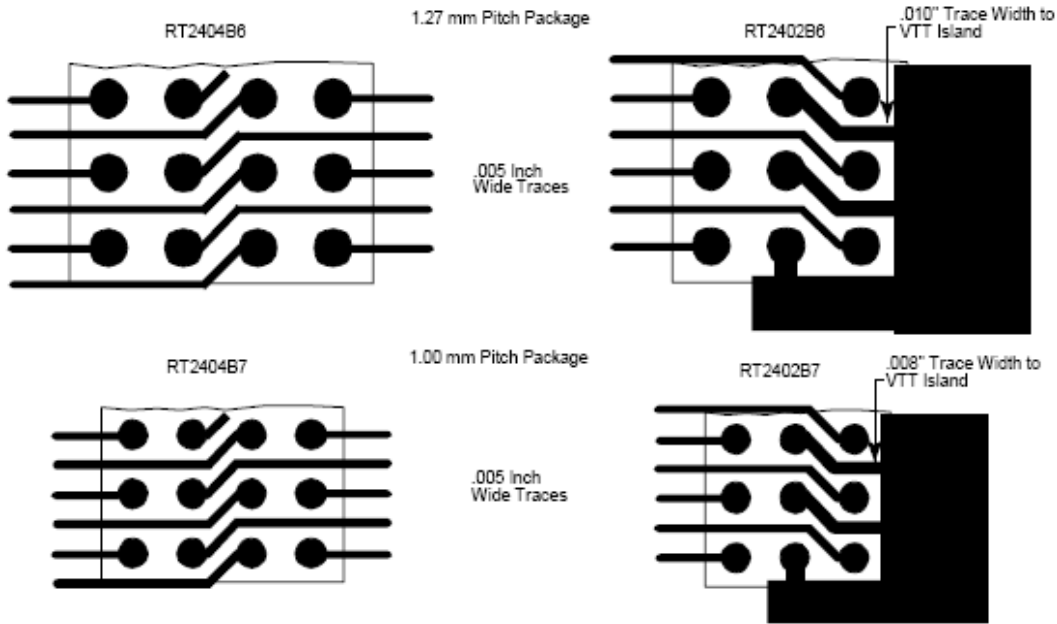

APPLICATIONS

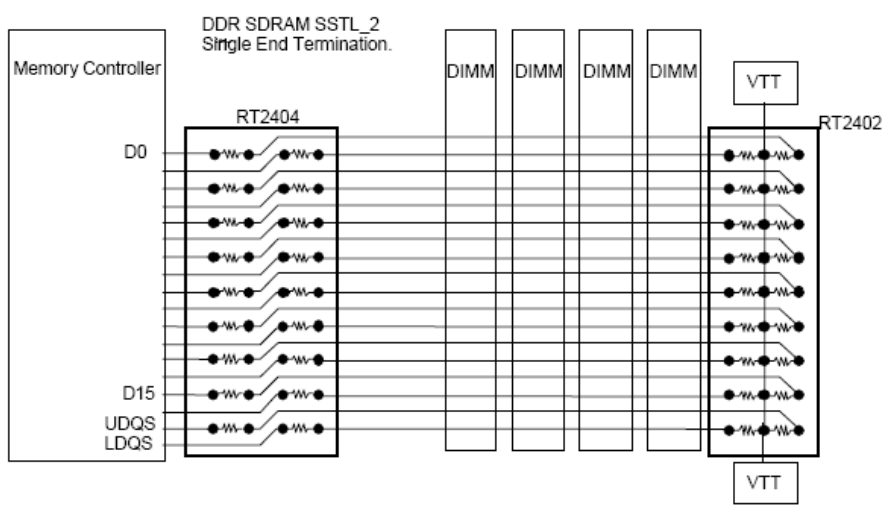
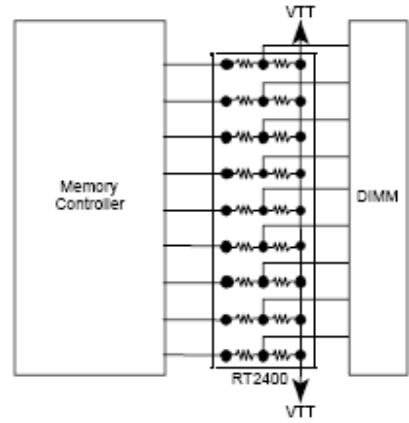
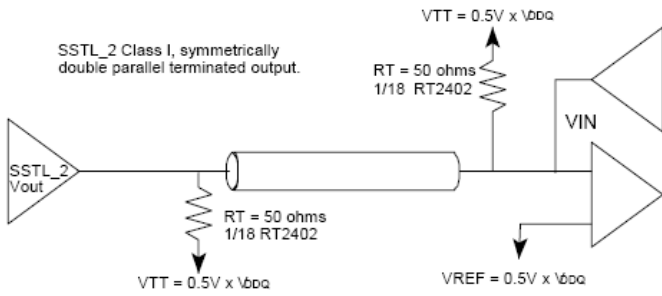
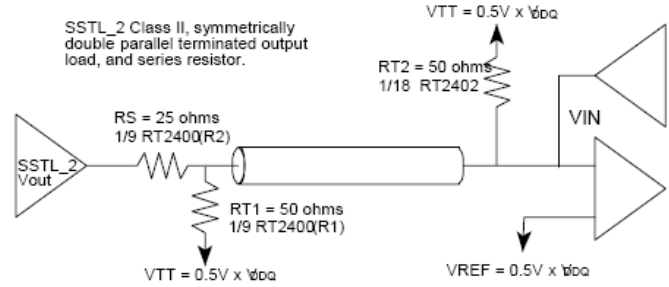
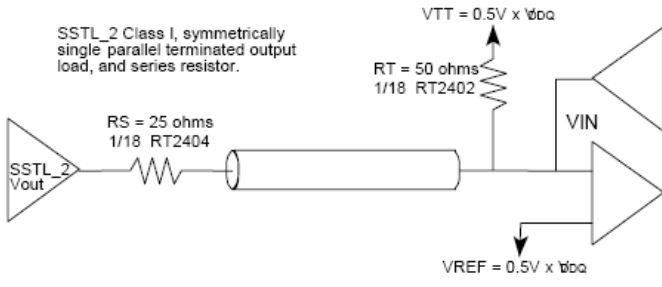

Complete ClearONE Product, Processing, and Application Information can be found at the following link:
<http://www.ctscorp.com/components/clearone.asp>

This product is covered by one or more of the following U.S. and foreign patents:
US 5,977,863; TW 133,148; US 6,005,777; US 6,194,979; TW 89104035; US 6,097,277; US 6,246,312; US 6,749,775; US 6,577,225; US 6,963,265;
US 6,897,761; US 6,882,266; US 6,946,733; US 6,856,516. Other U.S. and foreign patents pending.