

SERIES: PBK-1 | **DESCRIPTION:** AC-DC POWER SUPPLY

FEATURES

- up to 1 W continuous output
- compact SIP package
- single regulated outputs from 5~24 V
- 3,000 Vac isolation
- over current and short circuit protections
- CE, UL60950-1 safety approval
- wide input voltage: 70~400 Vdc (85~264 Vac)
- efficiency up to 70%

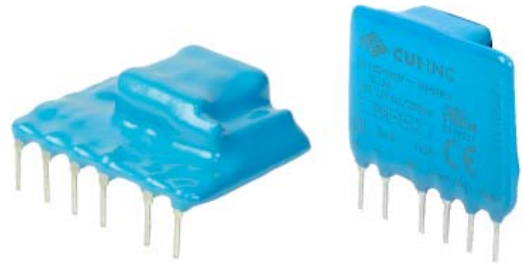

MODEL	output voltage	output current	output power	ripple and noise ¹	efficiency
	(Vdc)	max (mA)	max (W)	max (mVp-p)	typ (%)
PBK-1-5	5	200	1	120	66
PBK-1-9	9	111	1	120	67
PBK-1-12	12	83	1	120	70
PBK-1-15	15	67	1	120	69
PBK-1-24	24	42	1	120	68

Note: 1. Measured at 20 MHz bandwidth, see Test Configuration section.

PART NUMBER KEY

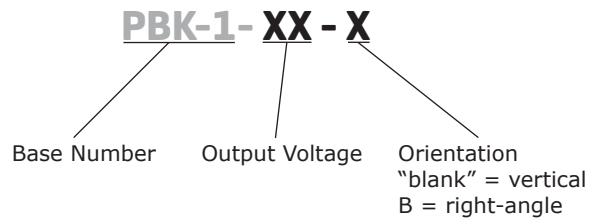

INPUT

parameter	conditions/description	min	typ	max	units
voltage		85		264	Vac
		70		400	Vdc
frequency		47		440	Hz
current	at 115 Vac			120	mA
	at 230 Vac			40	mA
inrush current	at 115 Vac at 230 Vac		10		A
			20		A
no load power consumption				0.5	W
input fuse	1 A/250 V, slow-blow type (external, required)				

OUTPUT

parameter	conditions/description	min	typ	max	units
output current		5			%
capacitive load	5 Vdc output models			220	μF
	all other models			100	μF
line regulation	at full load		±1.5		%
load regulation	at 5%~100% load		±2.5		%
voltage set accuracy	5 Vdc output models			±10	%
	all other models			±5	%
hold-up time	at 115 Vac	80			ms
	at 230 Vac	300			ms
switching frequency				50	kHz
temperature coefficient			±0.1		%/°C

PROTECTIONS

parameter	conditions/description	min	typ	max	units
short circuit protection	continuous, auto restart				
over current protection	auto restart				

SAFETY & COMPLIANCE

parameter	conditions/description	min	typ	max	units
isolation voltage	input to output, for 1 minute	3,000			Vac
isolation resistance		100			MΩ
safety approvals	UL60950-1, CE				
safety class	Class II				
conducted emissions	CISPR22/EN55022 external circuit required, Class A (see figure 2); Class B (see figure 3)				
radiated emissions	CISPR22/EN55022 external circuit required, Class A (see figure 2); Class B (see figure 3)				
ESD	IEC/EN61000-4-2 Class B, contact ±4 kV				
radiated immunity	IEC/EN61000-4-3 Class A, 10V/m (external circuit required, see figure 3)				
EFT/burst	IEC/EN61000-4-4 Class B, ±2 kV (external circuit required, see figure 2)				
	IEC/EN61000-4-4 Class B, ±4 kV (external circuit required, see figure 3)				
surge	IEC/EN61000-4-5 Class B, ±1 kV/±2 kV (external circuit required, see figure 3)				
conducted immunity	IEC/EN61000-4-6 Class A, 3 Vr.m.s (external circuit required, see figure 3)				
PFM	IEC/EN61000-4-8 Class A, 10 A/m				
voltage dips & interruptions	IEC/EN61000-4-11 Class B, 0%-70%				
MTBF	at 25°C, max. load	300,000			hours
RoHS	2011/65/EU				

ENVIRONMENTAL

parameter	conditions/description	min	typ	max	units
operating temperature	see derating curves	-40		85	°C
storage temperature		-40		105	°C
case temperature				90	°C
humidity	non-condensing			85	%

DERATING CURVES

load vs. ambient temperature
(at 110~240 Vac or 100~340 Vdc input voltage)

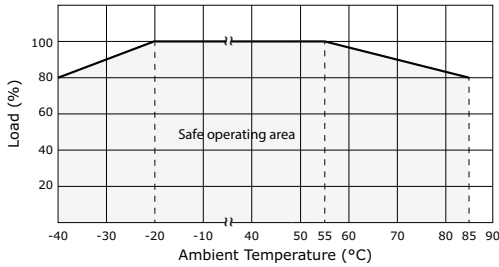

load vs. input voltage (Vac)
(at 25°C)

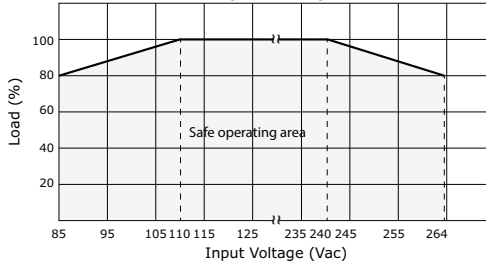

load vs. input voltage (Vdc)
(at 25°C)

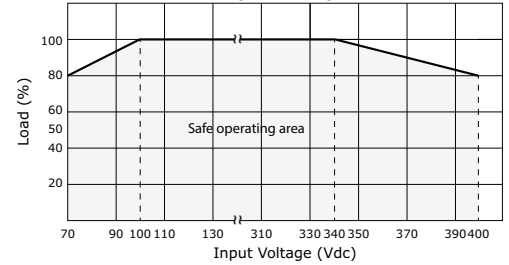

EFFICIENCY CURVES

efficiency vs. load
PBK-1-12

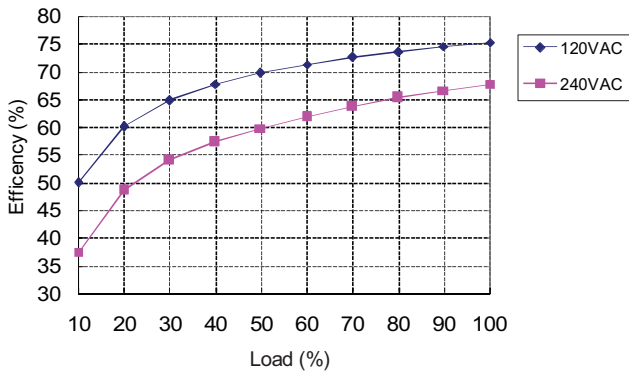

efficiency vs. input voltage (full load)

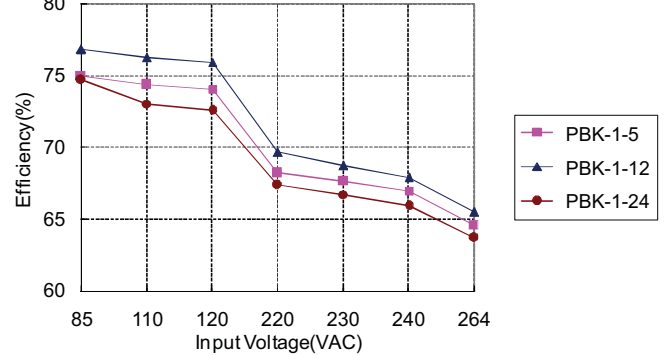

efficiency vs. load
PBK-1-12

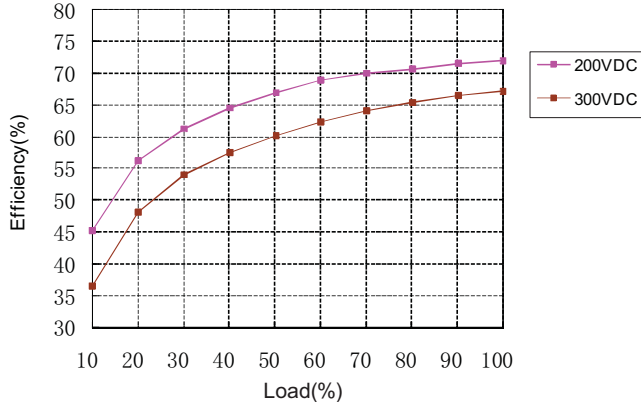

efficiency vs. input voltage (full load)

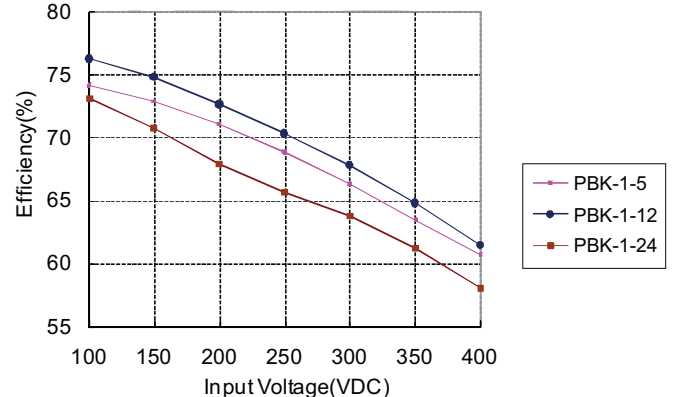

SOLDERABILITY

parameter	conditions/description	min	typ	max	units
hand soldering	for 3~5 seconds	350	360	370	°C
wave soldering	for 5~10 seconds	255	260	265	°C

MECHANICAL

parameter	conditions/description	min	typ	max	units
dimensions	vertical: 35 x 11 x 25 right-angle: 35 x 13 x 25				mm mm
material	UL94V-0				
weight			8		g

MECHANICAL DRAWING

VERTICAL ORIENTATION

units: mm[inch]
tolerance: ±0.5[±0.020]
pin tolerance: ±0.1[±0.004]

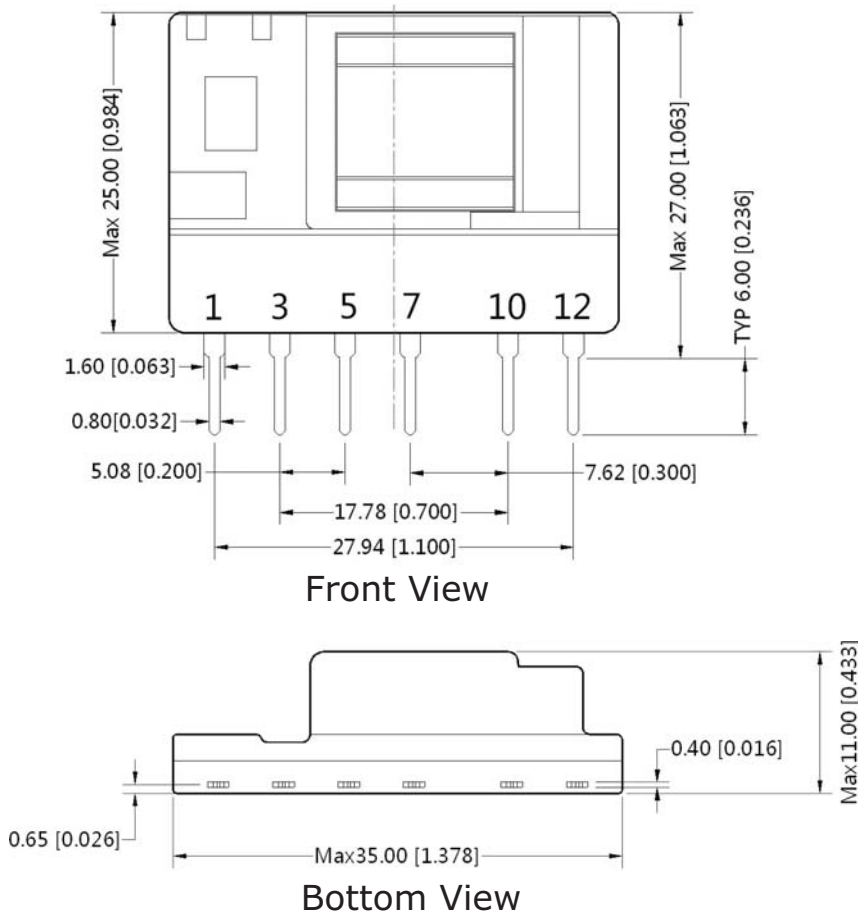

Note: Grid 2.54*2.54mm

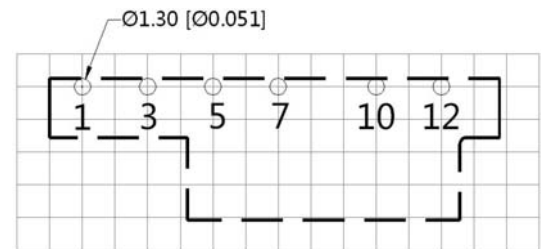

**Top View
PCB Layout**

PIN CONNECTIONS	
PIN	FUNCTION
1	-Vin (N)
3	+Vin (L)
5	+V(CAP)
7	-V(CAP)
10	-Vo
12	+Vo

Note: 1. It is required to add C1 between pins 5 & 7 (see application circuits).

MECHANICAL DRAWING (CONTINUED)

RIGHT-ANGLE ORIENTATION

units: mm[inch]
 tolerance: $\pm 0.5[\pm 0.020]$
 pin tolerance: $\pm 0.1[\pm 0.004]$

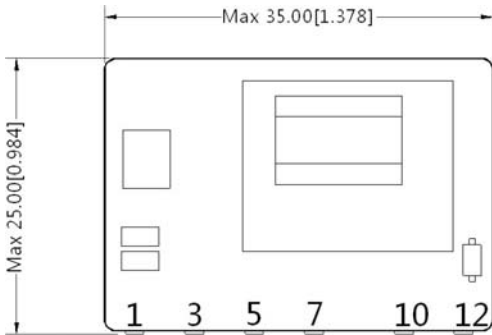

Front View

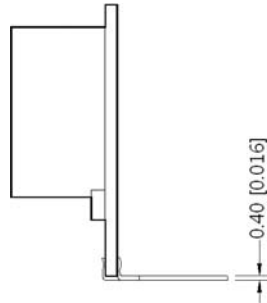

Side View

Note: Grid 2.54*2.54mm

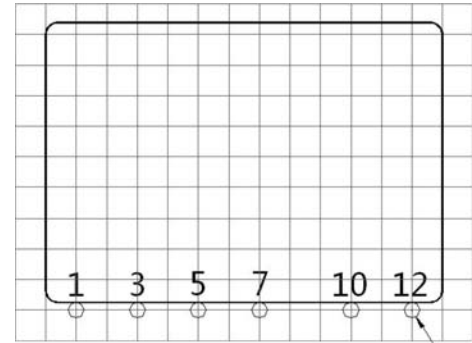

Top View
PCB Layout

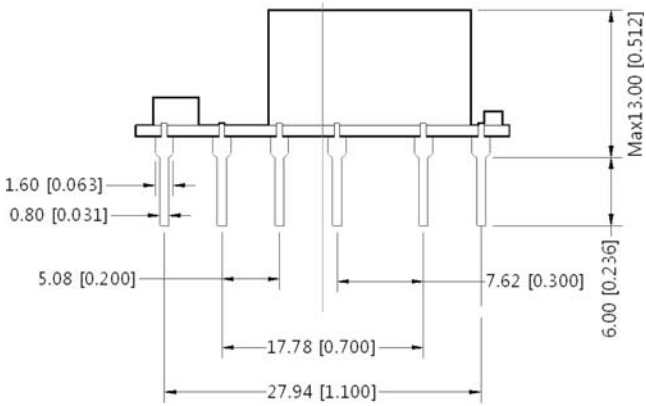

Bottom View

PIN CONNECTIONS	
PIN	FUNCTION
1	-Vin (N)
3	+Vin (L)
5	+V(CAP)
7	-V(CAP)
10	-Vo
12	+Vo

Note: 1. It is required to add C1 between pins 5 & 7 (see application circuits).

TEST CONFIGURATION

Figure 1
Connect Oscillograph Probe

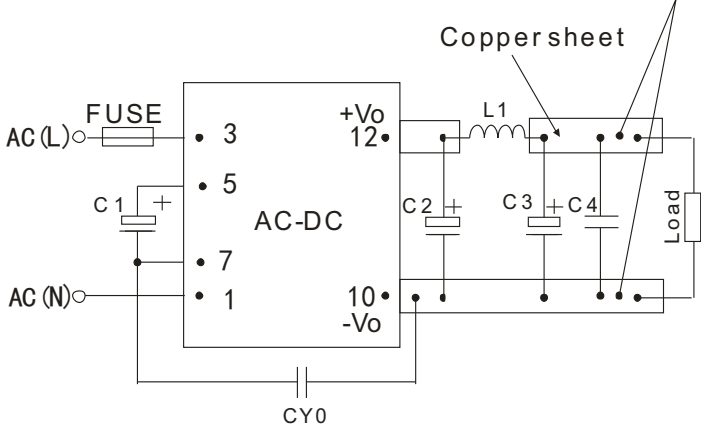

Table 1

V_{OUT} (Vdc)	Recommended External Circuit Components					
	C1 ¹	C2 ¹	L1 ¹	C3 ¹	C4	CY0 (Y1 capacitor)
5	10 μ F/400V	150 μ F/35V	2.2 μ H	68 μ F/35V	0.1 μ F/50V	1nF/400Vac
9	10 μ F/400V	150 μ F/35V	2.2 μ H	68 μ F/35V	0.1 μ F/50V	1nF/400Vac
12	10 μ F/400V	100 μ F/35V	2.2 μ H	68 μ F/35V	0.1 μ F/50V	1nF/400Vac
15	10 μ F/400V	100 μ F/35V	2.2 μ H	68 μ F/35V	0.1 μ F/50V	1nF/400Vac
24	10 μ F/400V	100 μ F/35V	2.2 μ H	68 μ F/35V	0.1 μ F/50V	1nF/400Vac

Note: 1. Required components.
 2. 1 A/250 V fuse required.

TYPICAL APPLICATION CIRCUIT

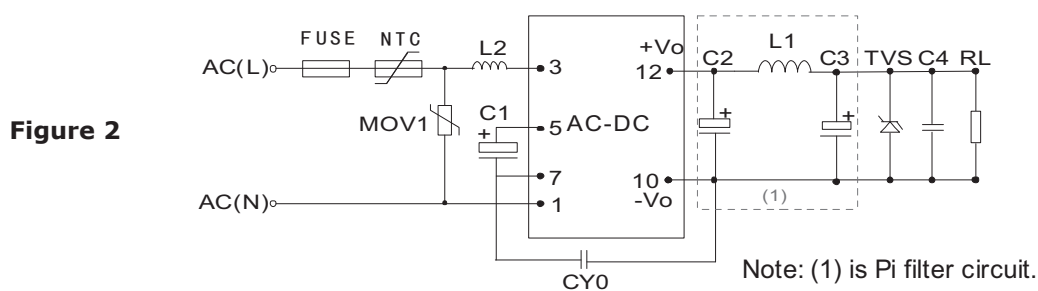

Table 2

Recommended External Circuit Components											
V_{OUT} (Vdc)	C1 ¹	L2	C2 ¹	L1 ¹	C3 ¹	C4	CY0	FUSE ¹	TVS	NTC	MOV1
5	10 μ F/400V	1mH	150 μ F/35V	2.2 μ H	68 μ F/35V	0.1 μ F/50V	1nF/400Vac	1A/250V	SMBJ7.0A	5D-9	S14K350
9	10 μ F/400V	1mH	150 μ F/35V	2.2 μ H	68 μ F/35V	0.1 μ F/50V	1nF/400Vac	1A/250V	SMBJ12A	5D-9	S14K350
12	10 μ F/400V	1mH	100 μ F/35V	2.2 μ H	68 μ F/35V	0.1 μ F/50V	1nF/400Vac	1A/250V	SMBJ20A	5D-9	S14K350
15	10 μ F/400V	1mH	100 μ F/35V	2.2 μ H	68 μ F/35V	0.1 μ F/50V	1nF/400Vac	1A/250V	SMBJ20A	5D-9	S14K350
24	10 μ F/400V	1mH	100 μ F/35V	2.2 μ H	68 μ F/35V	0.1 μ F/50V	1nF/400Vac	1A/250V	SMBJ30A	5D-9	S14K350

Note: 1. Required components.

EMC RECOMMENDED CIRCUIT

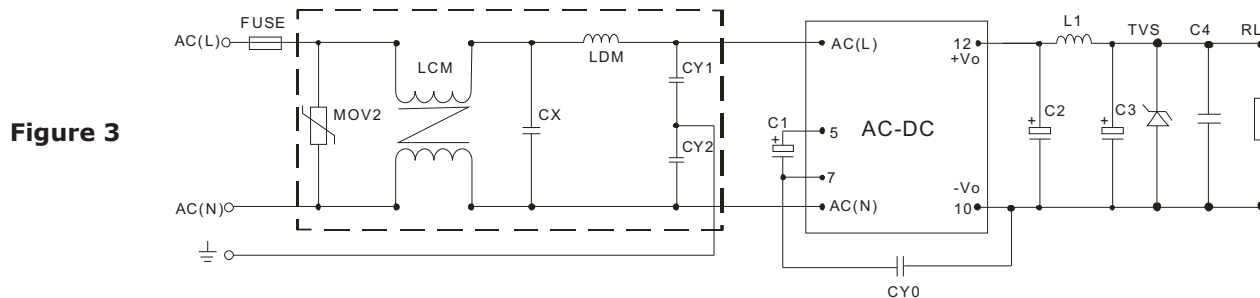

Table 3

Recommended External Circuit Components	
MOV2	S10K300
CY1, CY2	1nF/400Vac
CX	0.1 μ F/275Vac
LCM	3.5mH
LDM	5mH
FUSE	1A/250V, slow blow

Note: Also refer to Table 2.

- Notes:
- C1 and C3 are electrolytic capacitors. They are required for both AC input and DC input.
 - For AC input, C1 is used as a filter capacitor. The recommended C1 value is 10 μ F/400V.
 - For DC input, C1 is used as an EMC filter capacitor. The recommended C1 value is 10 μ F/400V. When the input voltage is above 370VDC, we recommend a 10 μ F/450V capacitor.
 - C2 and C3 are output filter capacitors, we recommend high frequency and low impedance electrolytic capacitors. For capacitance and rated ripple current of capacitors refer to the datasheets provided by the manufacturers, voltage derating of capacitors should be 80% or above.
 - C4 is a ceramic capacitor which is used to filter high frequency noise. C2, C3 and L1 form a pi-type filter circuit. For current of L1 and L2 refer to the datasheets provided by the manufacturers, current derating should be 80% or above. TVS is a recommended component to protect post-circuits (if converter fails). We recommend using a 5D-9 external input NTC.
 - For standard EMC requirements, please refer to figure 2. If a higher EMC is required, please refer to figure 3.
 - All specifications measured at Ta=25C, humidity <75%, 115 Vac & 230 Vac input voltage, and rated output load, unless otherwise specified.

REVISION HISTORY

rev.	description	date
1.0	initial release	08/09/2013
1.01	added bent pin model options, updated emc recommendations	03/25/2014

The revision history provided is for informational purposes only and is believed to be accurate.



Headquarters
20050 SW 112th Ave.
Tualatin, OR 97062
800.275.4899

Fax 503.612.2383
cui.com
techsupport@cui.com

CUI offers a two (2) year limited warranty. Complete warranty information is listed on our website.

CUI reserves the right to make changes to the product at any time without notice. Information provided by CUI is believed to be accurate and reliable. However, no responsibility is assumed by CUI for its use, nor for any infringements of patents or other rights of third parties which may result from its use.

CUI products are not authorized or warranted for use as critical components in equipment that requires an extremely high level of reliability. A critical component is any component of a life support device or system whose failure to perform can be reasonably expected to cause the failure of the life support device or system, or to affect its safety or effectiveness.