

**Standard Density Plug Inserts**

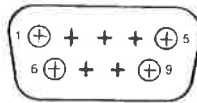

Shell Size E  
(9 Position)



Shell Size A  
(15 Position)

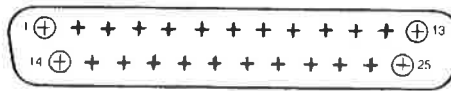

Shell Size B  
(25 Position)

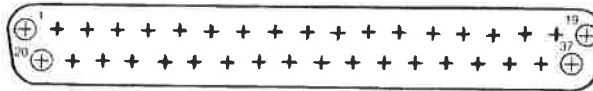

Shell Size C  
(37 Position)

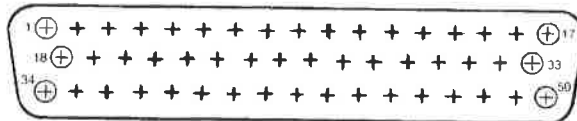

Shell Size D  
(50 Position)

NOTE: Mating face of plug is shown; socket is mirror image.

**Panel Mounting Specifications**

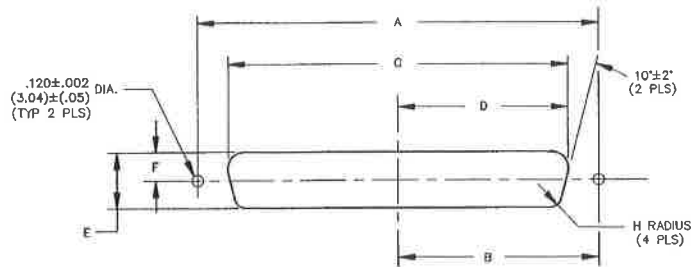

**Dimensions**

Shell Size	Positions	Mounting Method		A		B		C		D		E		F		H		
		Front/ Rear Panel	in	mm	in	mm	in	mm	in	mm	in	mm	in	mm	in	mm		
E	9	Front	0.98	24.89	0.49	12.45	0.87	22.10	0.44	11.18	0.51	12.95	0.26	6.60	0.08	2.03		
		Rear	0.98	24.89	0.49	12.45	0.81	20.57	0.40	10.16	0.45	11.43	0.23	5.84	0.13	3.30		
A	15	Front	1.31	33.27	0.66	16.76	1.10	27.94	0.60	15.24	0.51	12.95	0.26	6.60	0.08	2.03		
		Rear	1.31	33.27	0.66	16.76	1.13	28.70	0.57	14.48	0.45	11.43	0.23	5.84	0.13	3.30		
B	25	Front	1.85	46.99	0.93	23.62	1.74	44.20	0.87	22.10	0.51	12.95	0.26	6.60	0.08	2.03		
		Rear	1.85	46.99	0.93	23.62	1.67	42.42	0.84	21.34	0.45	11.43	0.23	5.84	0.13	3.30		
C	37	Front	2.50	63.50	1.25	31.75	2.39	60.71	1.20	30.48	0.51	12.95	0.26	6.60	0.08	2.03		
		Rear	2.50	63.50	1.25	31.75	2.33	59.18	1.16	29.46	0.45	11.43	0.23	5.84	0.13	3.30		
D	50	Front	2.41	61.21	1.20	30.48	2.30	58.42	1.15	29.21	0.62	15.75	0.31	6.60	0.08	2.03		
		Rear	2.41	61.21	1.20	30.48	2.22	56.39	1.11	28.19	0.56	14.22	0.28	5.84	0.13	3.30		

4

**PANEL MOUNTING HARDWARE: Aids in alignment of plug and receptacle.**

**Float Bushing**

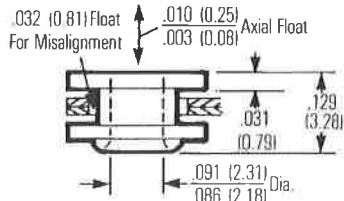

Rear panel mounting

**Reverse Float Bushing**

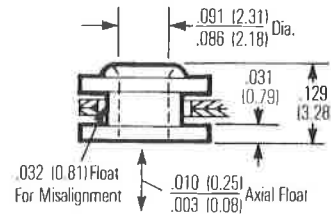

Front panel mounting

**Floating Dual Bushing**

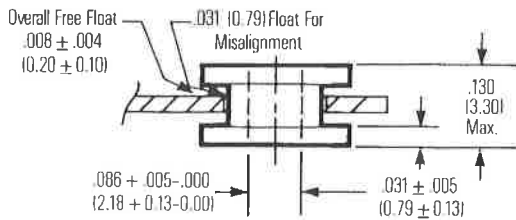

Front and rear panel mounting

**4-40 Clinch Nut**

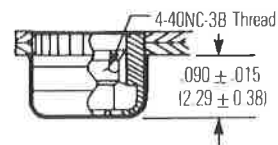

Rear panel mounting

# D-subminiature Connectors Information

## Introduction Shells and Mounts

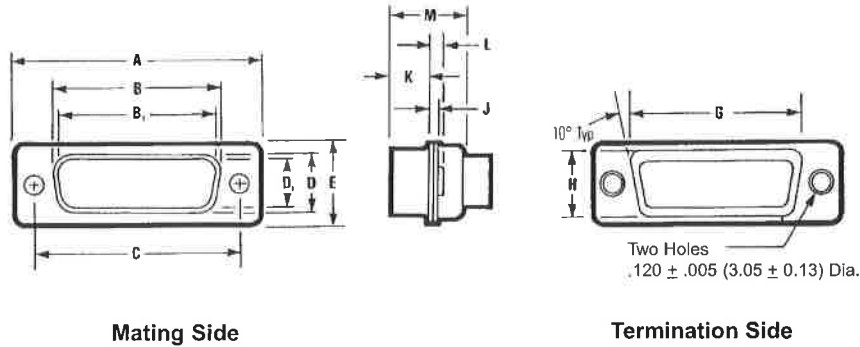

Mating Side

Termination Side

Shell Size	Positions	Connector Type	A ±.015" (0.38mm)		B ±.010" (0.25mm)		B <sub>1</sub> ±.005" (0.13 mm)		C ±.005" (0.13mm)		D ±.010" (0.25mm)		D <sub>1</sub> ±.010" (0.25mm)		E ±.010" (0.25mm)	
			in	mm	in	mm	in	mm	in	mm	in	mm	in	mm	in	mm
E	9	Plug	1.213	30.81	--	--	.666	16.90	0.984	24.99	--	--	.329	8.40	.494	12.55
		Socket	1.213	30.81	.640	16.26	--	--	0.984	24.99	.308	7.82	--	--	.494	12.55
A	15	Plug	1.541	39.14	--	--	.994	25.30	1.312	33.32	--	--	.329	8.40	.494	12.55
		Socket	1.541	39.14	.968	24.59	--	--	1.312	33.32	.308	7.82	--	--	.494	12.55
B	25	Plug	2.088	53.04	--	--	1.534	39.00	1.852	47.04	--	--	.329	8.40	.494	12.55
		Socket	2.088	53.04	1.508	38.30	--	--	1.852	47.04	.308	7.82	--	--	.494	12.55
C	37	Plug	2.729	69.32	--	--	2.182	55.40	2.500	63.50	--	--	.329	8.40	.494	12.55
		Socket	2.729	69.32	2.156	54.76	--	--	2.500	63.50	.308	7.82	--	--	.494	12.55
D	50	Plug	2.635	66.93	--	--	2.079	52.80	2.406	61.11	--	--	.436	11.07	.605	15.37
		Socket	2.635	66.93	2.062	52.34	--	--	2.406	61.11	.420	10.67	--	--	.605	15.37

Shell Size	Positions	Connector Type	G ±.010" (0.25mm)		H ±.010" (0.25mm)		J ±.010" (0.25 mm)		K ±.005" (0.25mm)		L ±.010" (0.25mm)		M ±.010" (0.25mm)	
			in	mm	in	mm	in	mm	in	mm	in	mm	in	mm
E	9	Plug	.759	19.28	.422	10.72	.030	0.76	.236	5.99	.045	1.14	.422	10.72
		Socket	.759	19.28	.422	10.72	.030	0.76	.243	6.17	.045	1.14	.429	10.92
A	15	Plug	1.083	27.51	.422	10.72	.030	0.76	.236	5.99	.045	1.14	.422	10.72
		Socket	1.083	27.51	.422	10.72	.030	0.76	.253	6.17	.045	1.14	.429	10.92
B	25	Plug	1.625	41.27	.422	10.72	.039	0.99	.231	5.87	.060	1.52	.426	10.82
		Socket	1.625	41.27	.422	10.72	.030	0.76	.243	6.17	.045	1.14	.429	10.92
C	37	Plug	2.272	57.71	.422	10.72	.039	0.99	.231	5.87	.060	1.52	.426	10.82
		Socket	2.272	57.71	.422	10.72	.030	0.76	.243	6.17	.045	1.14	.429	10.92
D	50	Plug	2.178	55.32	.534	13.56	.039	0.99	.231	5.87	.060	1.52	.426	10.82
		Socket	2.178	55.32	.534	13.56	.030	0.76	.243	6.17	.045	1.14	.429	10.92

B and D are outside dimensions for socket. D and B are inside dimensions for plug.

4

**Standard Density D-subminiature  
Mounting Dimensions Board Layouts  
Footprints (Component side shown)**

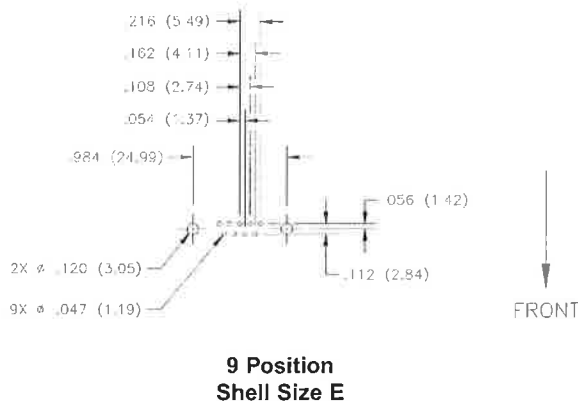

**9 Position  
Shell Size E**

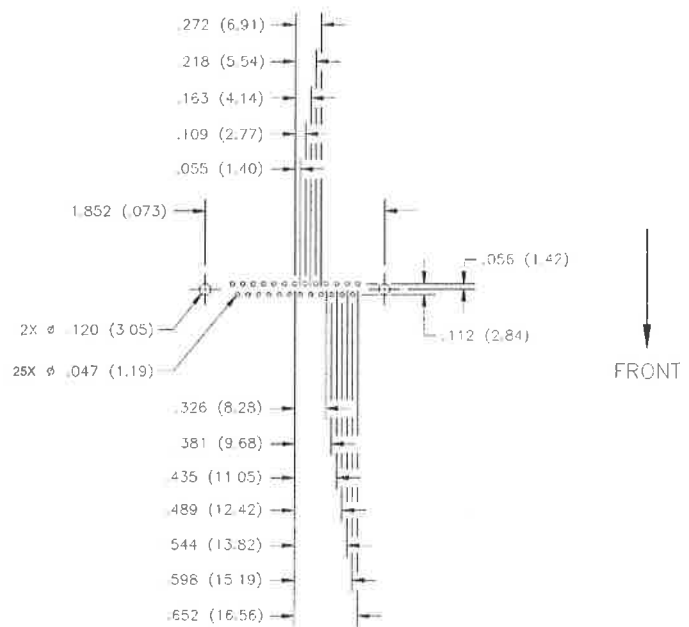

**25 Position  
Shell Size B**

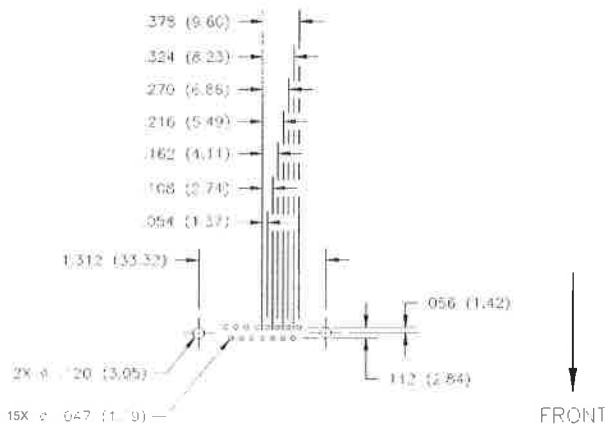

**15 Position  
Shell Size A**

**4**

The footprints on this page are standard for all metal shell D-subminiature connectors.

On all right-angle D-subminiature connectors, the short row of contacts is positioned closest to the edge of the board.

**PC Board Lead Hole Size**

Terminal Dia.		Hole Dia.	
in	mm	in	mm
.040	1.02	.055	1.40
.030	0.76	.045	1.14
.024-.025	0.61-0.64	.039	0.99

**Standard Density D-subminiature  
Mounting Dimensions Board Layouts  
Footprints (Component side shown)**

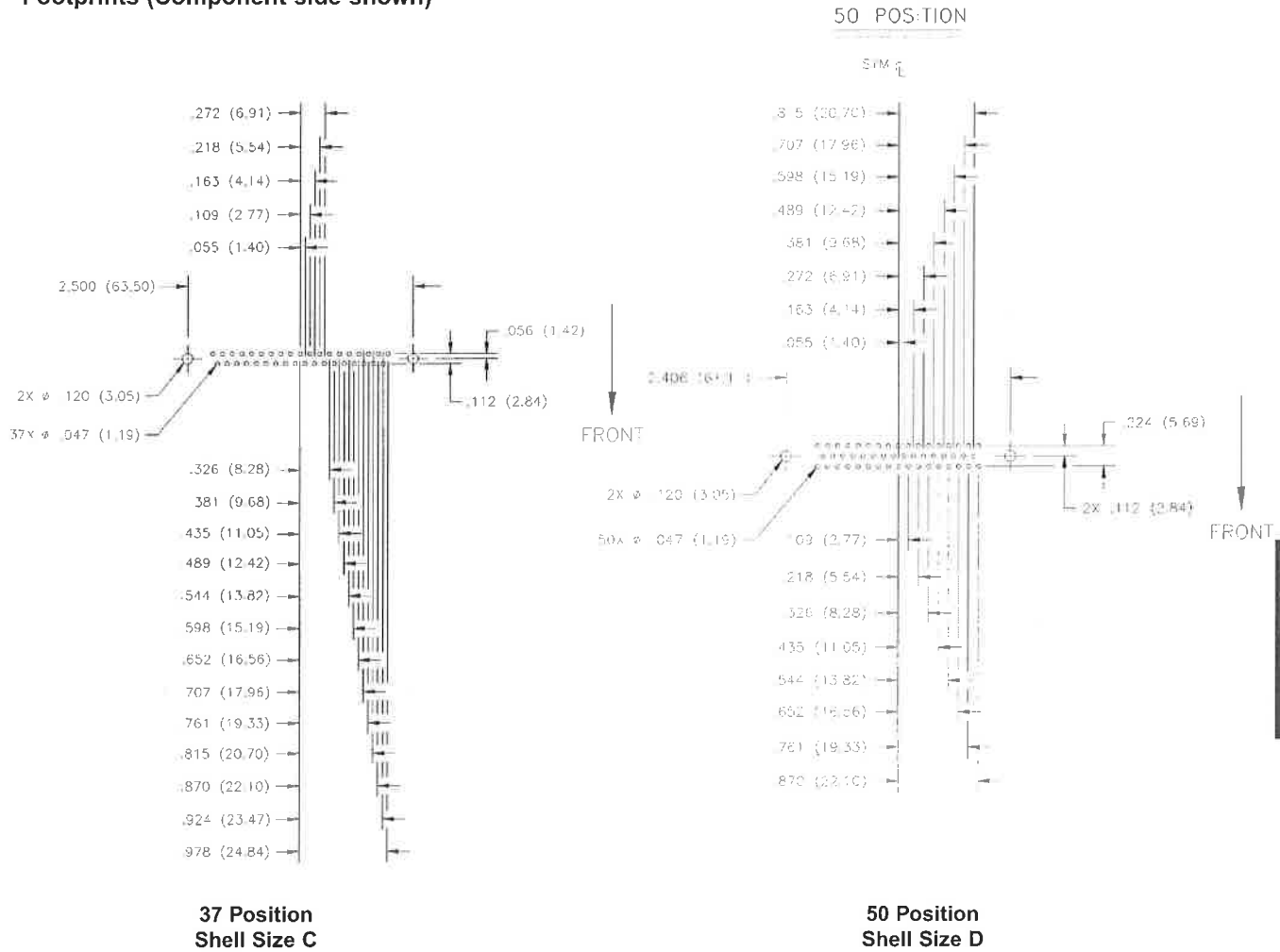

The footprints on this page are standard for all metal shell D-subminiature connectors.

On all right-angle D-subminiature connectors, the short row of contacts is positioned closest to the edge of the board.

**PC Board Lead Hole Size**

Terminal Dia.		Hole Dia.	
in	mm	in	mm
.040	1.02	.055	1.40
.030	0.76	.045	1.14
.024-.025	0.61-0.64	.039	0.99