



Features

- 3" x 5" x 1.40" Package
- Up to 275W of AC-DC Power
- For 1U Applications
- Universal Input 90-264 Vac Input Range
- Standby and Fan Output Voltages
- Forced Current Share
- Inhibit, Power Fail, Output OK Signals
- Approved to CSA/EN/IEC/UL60950-1, 2nd Edition
- Efficiency 92% typical
- 3 Year Warranty
- RoHS Compliant



Description

A Superior performance 275 Watts AC to DC power supply designed for industrial and ITE applications. Feature rich and highly efficient CINT1275 product family with active current share for redundant applications can easily fit in 1U chassis and provides 180 Watts for convection or 275 Watts with moving air. Input & output monitoring alarms plus 12V/1A fan output and 5V standby voltage are among other standard offering of CINT1275 family. All 5 models are CE marked to low voltage directive and approved to ITE standards of EN60950, 2nd edition.

Model Selection

Model Number	Volts	Output Current		Fan Output	Ripple & Noise**	Total Regulation	OVP Threshold***
		w/200LFM air	Convection*				
CINT1275A1214K01	12V	21.8A	15.0A	12Vdc/1A	120mV pk-pk	±3%	14.0 ± 1.1V
CINT1275A1514K01	15V	18.3A	12.0A	12Vdc/1A	150mV pk-pk	±3%	19.5 ± 1.5V
CINT1275A2414K01	24V	10.9A	7.50A	12Vdc/1A	240mV pk-pk	±3%	28.0 ± 2.5V
CINT1275A4814K01	48V	5.46A	3.75A	12Vdc/1A	480mV pk-pk	±3%	55.0 ± 4.0V
CINT1275A5614K01	56V	4.68A	3.21A	12Vdc/1A	560mV pk-pk	±3%	59.0 ± 1.0V

Notes: * Total convection power is 180 Watts.

** Measured with noise probe directly across output terminals, and load terminated with 0.1µF ceramic and 10µF low ESR capacitors.

*** No output adjustment on 56V.

General Specifications

AC Input	100-240Vac, ±10%, 47-63Hz, 1Ø 120-370Vdc	Turn On Time	Less than 2 sec. @115Vac (inversely proportional to input voltage and thermistor temperature)
Input Current	115Vac: 3A, 230Vac: 1.5A 3.7A max. at 90Vac	Hold-up Time	16mS at 250W, 120Vac/60Hz
Inrush Current	264Vac, cold start: will not exceed 50A	Overtemperature Protection	Sensing transformer temperature, 135°C (55°C ambient temperature at full load), latching type.

General Specifications (continued)

Input Fuses	F1, F2: 5A, 275Vac fuses provided on all models	Overload Protection	120 to 150% of rating, Hiccup Mode
Earth Leakage Current	<750 μ A@264Vac, 60Hz, NC	Short Circuit Protection	Hiccup Mode, auto recovery.
Efficiency	92% typical	Overvoltage Protection	OVP latch at 110 to 130% of output voltage
Output Power	275W continuous, with 200 lfm airflow, 180W convection cooled – See chart for specific voltage model ratings.	Switching Frequency	PFC: Variable, 30kHz - 400kHz Main Converter: Variable 30-250kHz, 65-70kHz at full load.
Transient Response	500 μ S typical, return to 0.5% of nominal, 50% load step. $\Delta i/\Delta t$: <0.2A/ μ S. Max Voltage Deviation = 3%	Isolation	Input-Output: 4000Vac Input-Ground: 1800Vac Output-Ground: 1500Vac
Ripple and Noise	0.5%rms, 1% pk-pk, see chart.	Operating Temperature	-10 °C to +70 °C Start Up at -40 °C, full load
Output Voltage	See chart	Temperature Derating	Derate output power linearly above 50 °C to 50% at 70 °C
Voltage Adjustability	+/-5% from nominal (except 56V)	Storage Temperature	-40 °C to +85 °C
Minimum Load	Not required	Altitude	Operating: -500 to 10,000 ft. Non-operating: -500 to 40,000 ft.
Total Regulation	+/- 3% combined line, load and initial setting.	Relative Humidity	5% to 95%, non-condensing
Vibration	Operating: 0.003g/Hz, 1.5grms overall, 3 axes, 10 min/axis Non-Operating: 0.026g ² /Hz, 5.0grms overall, 3 axes, 1 hr/axis	Shock	Operating: Half-sine, 20gpk, 10ms, 3 axes, 6 shocks total Non-Operating: Half-sine, 40 gpk, 10 ms, 3 axes, 6 shocks total
Dimensions	W: 3.0" x L: 5.0" x H: 1.40" (from bottom of PC Board).	Safety Standards	EN/CSA/UL/IEC 60950-1, 2nd Edition
Weight	325g	MTBF	465,000 hours, 275W load, 110Vac input, 25 °C ambient

Auxiliary Signals

Standby Output	5V @ 200 mA	DC OK:	Open collector logic signal goes and stays HIGH 100mS to 500mS after main output reaches regulation.
AC Power Fail:	Goes LOW with 5mS warning before loss of DC output after loss of AC power.	Fan Output:	12V @ 1A
Inhibit:	Connect to inhibit pin (J201 pin 5) to output common to inhibit the DC output.	Current Share:	Forced Current Sharing provided for up to 5 units connected in parallel.
Remote Sense:	Compensates for up to 250mV drop in load lines.		

EMI/EMC Compliance

Conducted Emissions	EN55011/22 Class B, FCC Part 15, Subpart B, Class B
Radiated Emissions	EN55011/22 Class A, FCC Part 15, Subpart B, Class A w/6db margin
Static Discharge Immunity	EN61000-4-2, 6kV Contact Discharge, 8kV air discharge
Radiated RF Immunity	EN61000-4-3, 3V/m.
EFT/Burst Immunity	EN61000-4-4, 2kV/5kHz
Line Surge Immunity	EN61000-4-5, 1kV differential, 2kV common-mode
Conducted RF Immunity	EN61000-4-6, 3Vrms
Power Frequency Magnetic Field Immunity	EN61000-4-8, 3A/m
Voltage Dip Immunity	EN61000-4-11, 100%, 10ms; 30%, 275ms; 60%, 100ms; Performance Criteria A, A, & A at 70% load.
Line Harmonic Emissions	EN61000-3-2, Class A, B, C, & D
Flicker Test	EN61000-3-3, Complies (dmax<6%)

Mechanical Drawing

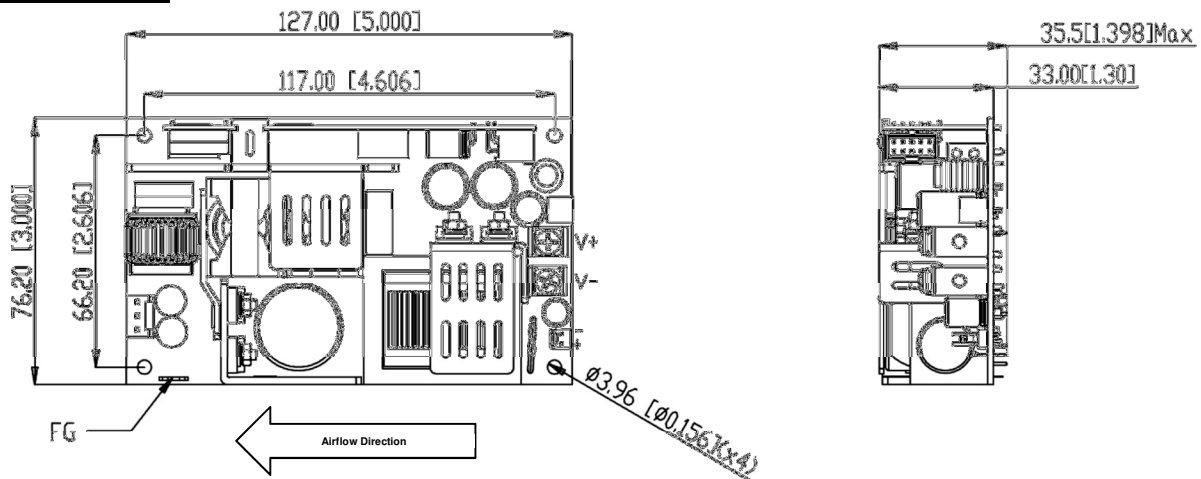

- Notes:**
1. All dimensions in inches (mm), tolerance is +/-0.02".
 2. Mounting holes should be grounded for EMI purposes.
 3. FG is safety ground connection.
 4. The power supply requires mounting on metal standoffs 0.20" (5mm) in height, min.

Connector Information

Input Connector	Ground	DC Output Connector	Fan Output Connector	Signal Connector
PIN 1) AC LINE PIN 2) EMPTY PIN 3) AC NEUTRAL	0.25" FASTON TAB	Term. 1: +Vout Term. 2: -Vout	PIN 1) +12V fan RTN PIN 2) +12V fan	PIN 1) Remote Sense (+) PIN 2) Common PIN 3) Remote Sense (-) PIN 4) Current Share PIN 5) Inhibit Pin 6) Common Pin 7) Power Good Pin 8) +5Vsb Pin 9) DC OK Pin 10) +5Vsb RTN
Mating Connector: Molex 09-50-3031 Pins: 08-52-0072	Mating Connector: Molex 01- 90020001	Mating Connector: Molex 19141- 0058/0063/0083	Mating Connector: Molex 22-01-3027 Pins: 08-50-0114	Mating Connector: Molex 90142-0010 Pins: 90119-2109 or 2120

Fan Output – J301

J301 provides a 12V@1A output to support a system cooling fan.

AC Power Failure/DC OK Current Share and Inhibit Signals – J201

1. Power fail/DC OK

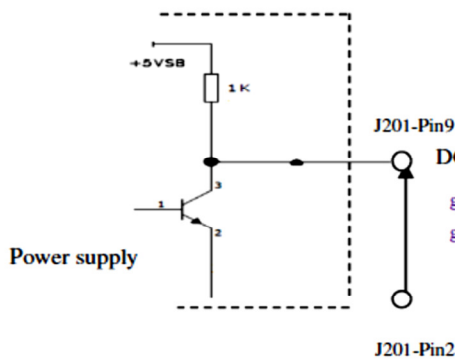

Note: Because Power Fail and DC OK use the same pin, the signals can be monitored as follows:

DC OK: When J201-Pin 9 is HIGH
AC Power Fail: When J201-Pin 9 is LOW

DC OK: During normal operation stays HIGH

goes HIGH 100-500 ms after main output

goes LOW with 5ms warning before loss of output from AC failure

Figure 1

2. Inhibit

Remote inhibit control of the DC output.

J201 pin 5 open = ON
J201 pin 5 LOW or GND = OFF

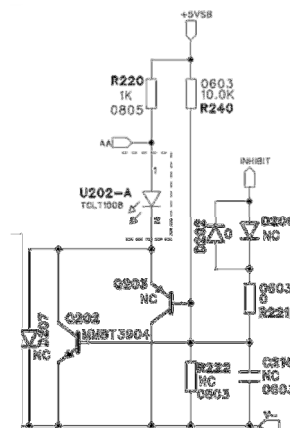

Figure 2: Inhibit Circuit

3. Current Sharing/Remote Sense

The outputs of N+1 (N=1,2...5) models can be shared. It is shown in Figure 3, one load-share controller is required for each model and circuits are identical when N+ 1 identical models are used.

Terminals J302 and J303 are connected to the Vo+ and Vo-, respectively, of the first power model. The Vo+ and Vo- correspond to the other models positive and negative output pins. The Vo+ connects to positive output bus to the load and Vo- connects the negative output bus to the load.

The J201 pin1 and pin3 connects to the S+ and S-, respectively, of the first power models. The S+ and S- correspond to the other models J201 pin1 and pin3. The S+ connects to positive output bus and S- connects to negative output bus.

Remote Sense < 250mV drop compensation:

The J201 Pin4 connects to current sharing bus that it connects to other models J201 pin4.

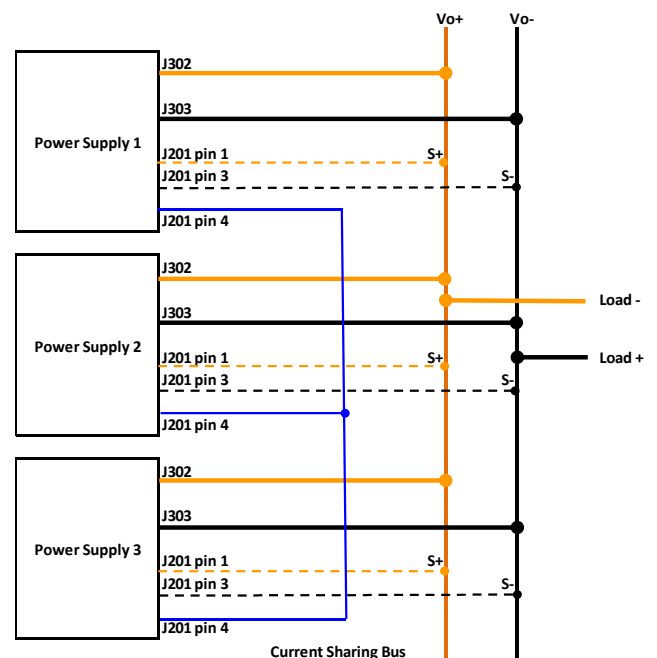
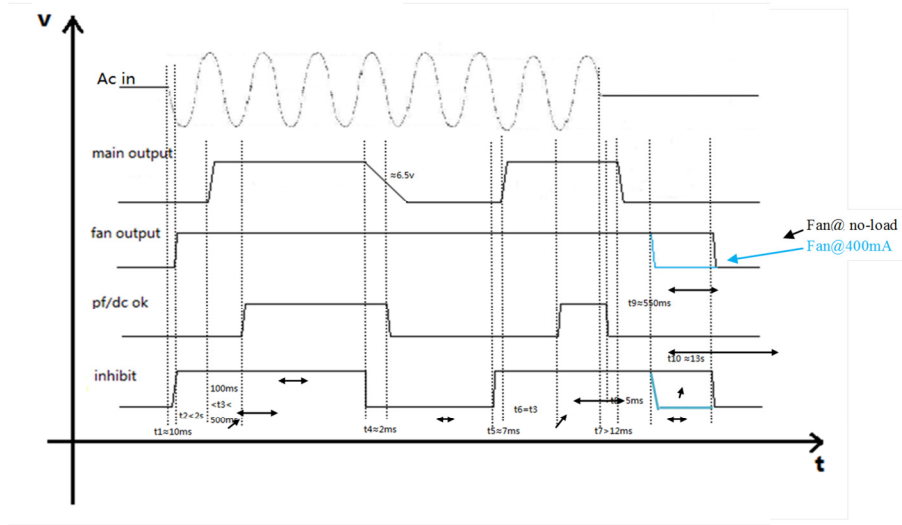

Figure 3: Current Share Method

Timing Sequence



Isolation Specifications

Parameter	Conditions/Description	Min	Nom	Max	Units
Insulation Safety Rating	Input/Ground Input/Output Output/Ground		Basic Reinforced n/a		
Electric Strength Test Voltage	Input/Ground Input/Output Output/Ground	1800 4000 1500	-	-	Vac Vac Vac

Input Specifications

All specifications apply over specified input voltage, output load, and temperature range, unless otherwise noted.

Parameter	Conditions/Description	Min	Nom	Max	Units
Input Voltage		90	115/230	264	Vac
Turn-On Input Voltage	Ramping up		80		Vac
Turn-Off Input Voltage	Ramping down		75		Vac
Input Frequency		47	50/60	63	Hz
Inrush Current Limitation	264Vac, cold start	-	-	50	A
Power Factor	$V_{i\text{ nom}}, I_{o\text{ nom}}$	0.9	-	-	
Efficiency	$V_{i\text{ nom}}, I_{o\text{ nom}}$ CINT1275A1214K01 CINT1275A1514K01 CINT1275A2414K01 CINT1275A4814K01 CINT1275A5614K01	-	92%	-	%

Output Specifications

Parameter	Conditions/Description	Min	Nom	Max	Units
Output Voltage Setpoint Accuracy CINT1275A1214K01	$V_{i \text{ nom, } I_{o1}} @ \text{ADC}, TC = 25^\circ\text{C}$	-3	-	3	% $V_o \text{ nom}$
Output Voltage Setpoint Accuracy CINT1275A1514K01	$V_{i \text{ nom, } I_{o1}} @ \text{ADC}, TC = 25^\circ\text{C}$	-3	-	3	% $V_o \text{ nom}$
Output Voltage Setpoint Accuracy CINT1275A2414K01	$V_{i \text{ nom, } I_{o1}} @ \text{ADC}, TC = 25^\circ\text{C}$	-3	-	3	% $V_o \text{ nom}$
Output Voltage Setpoint Accuracy CINT1275A4814K01	$V_{i \text{ nom, } I_{o1}} @ \text{ADC}, TC = 25^\circ\text{C}$	-3	-	3	% $V_o \text{ nom}$
Output Voltage Setpoint Accuracy CINT1275A5614K01	$V_{i \text{ nom, } I_{o1}} @ \text{ADC}, TC = 25^\circ\text{C}$	-3	-	3	% $V_o \text{ nom}$
Output Current V1 Output Current V2	CINT1275A1214K01	0 0	15.0 -	21.83 1.0	ADC ADC
Output Current V1 Output Current V2	CINT1275A1514K01	0 0	12.0 -	17.47 1.0	ADC ADC
Output Current V1 Output Current V2	CINT1275A2414K01	0 0	7.5 -	10.92 1.0	ADC ADC
Output Current V1 Output Current V2	CINT1275A4814K01	0 0	3.75 -	5.46 1.0	ADC ADC
Output Current V1 Output Current V2	CINT1275A5614K01	0 0	3.21 -	4.68 1.0	ADC ADC
Static Line Regulation V1	$V_i \text{ min-} V_i \text{ max}, V_{i \text{ nom}}, 0\text{-}100\% I_o \text{ nom}$	-1	-	1	% $V_o \text{ nom}$
Static Load Regulation V1 (Droop Characteristic)	$V_i \text{ min-} V_i \text{ max}, V_{i \text{ nom}}, 0\text{-}100\% I_o \text{ nom}$	-3	-	3	% $V_o \text{ nom}$
Hold-Up Time	Starting at $V_i = 230 \text{ VAC}, P_o \text{ nom}$	-	16	-	ms
Dynamic Load Regulation	Load change =50%, di/dt =0.2A/ μs voltage deviation 3%	0		3	% $V_o \text{ nom}$
Start-Up Time	$V_{i \text{ nom}}, I_o \text{ nom}$	0	-	2	s

Protection

All specifications apply over specified input voltage, output load, and temperature range, unless otherwise noted

Parameter	Conditions/Description	Min	Nom	Max	Units
Input Fuse	Not user accessible				
Input Transient Protection	2KV(CM) and 1KV(DM) surge			2	KV (CM)
Output	No-load and short circuit proof				Hiccup
	short circuit proof				Hiccup
	overload (latch style)				Hiccup
Overvoltage Protection	Latch style				Latch
Over temperature Protection	Automatic power shutdown at $TC = 135^\circ\text{C}$				

Characteristic Curves

Output vs. Temperature

180W convection cooled and 275W continuous with 200 LFM airflow, derate output power to 50% at 70°C.

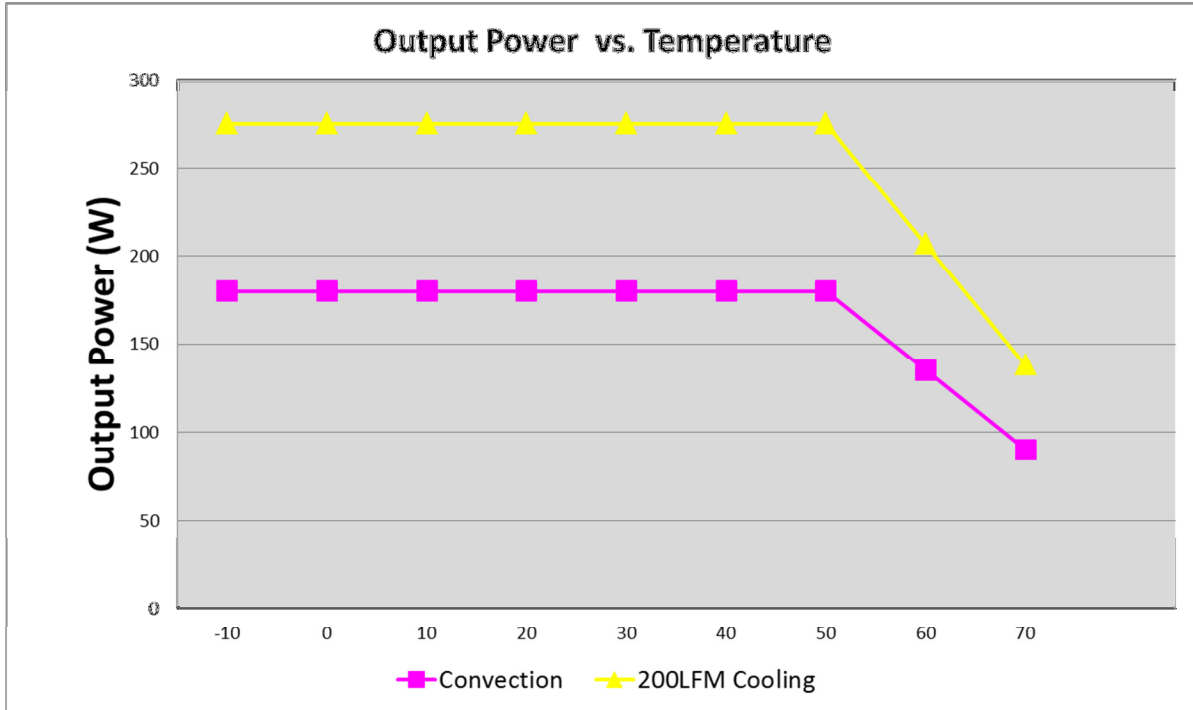

Efficiency vs. Loading

The high efficiency is achieved by using LLC technology with CCM mode PFC topology, and synchronous rectifiers on the output in all of this family models, minimizing switching losses.

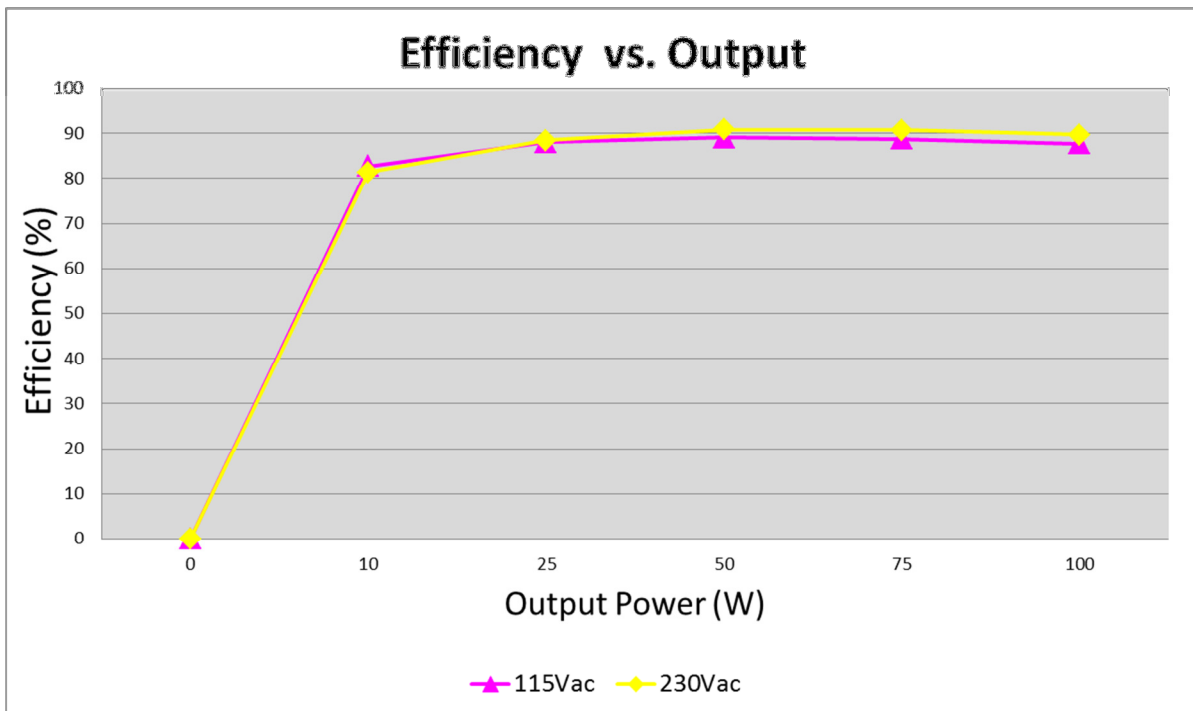

Noise & Ripple

To verify that the output ripple and noise does not exceed the level specified in the product specification. Measured using a scope probe socket with 0.1uF ceramic and a 10uF electrolysis capacitor connected in parallel across it, BW limit with 20MHz.

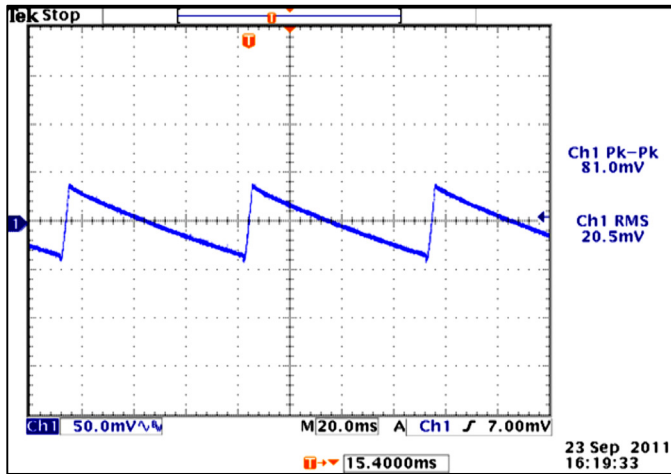

[12V OUT, NO LOAD, 115VAC, 60Hz](#)

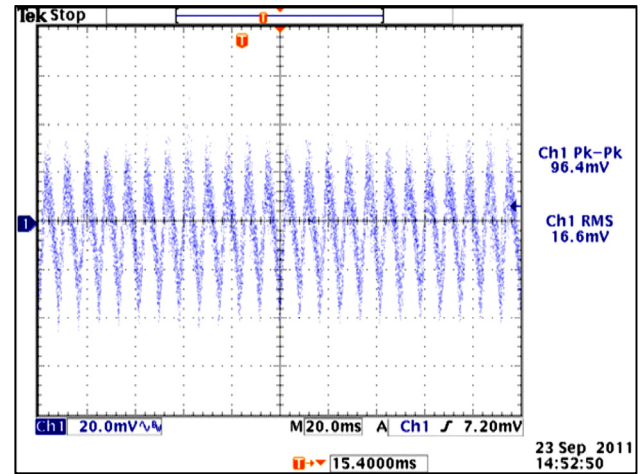

[12V OUT, FULL LOAD, 115VAC, 60Hz](#)

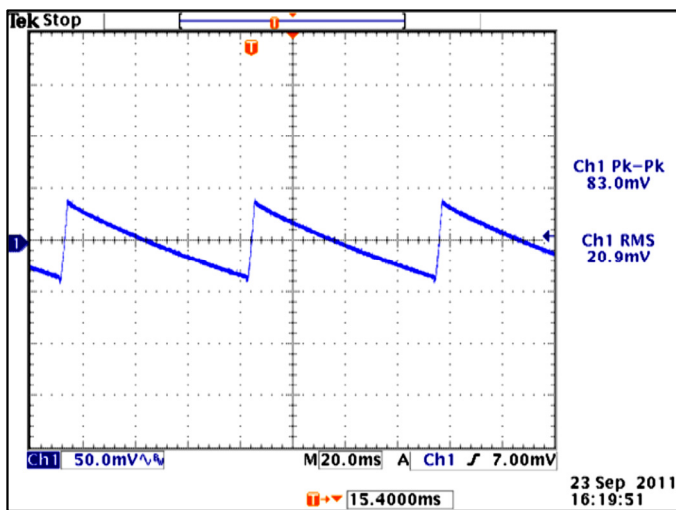

[12V OUT, NO LOAD, 230VAC, 60Hz](#)

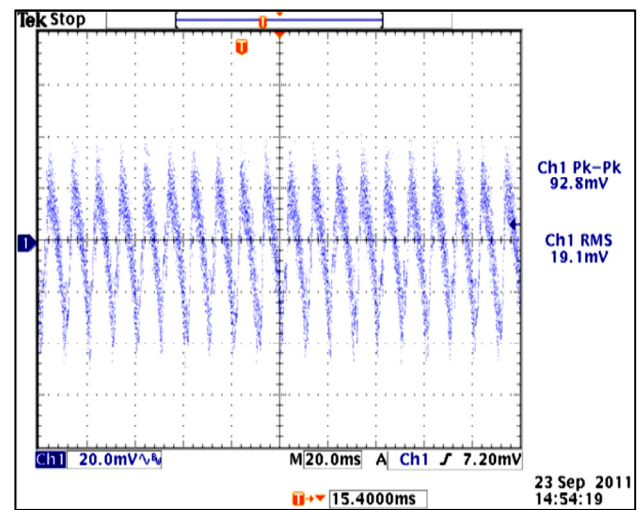

[12V OUT, FULL LOAD, 230VAC, 60Hz](#)

Output Transient Response

50% load step within the regulation limits of minimum and maximum load, $di/dt < 0.2A/\mu\text{Sec}$. Recovery time not specified as there is no laps in regulation with a 50% Load Step. Maximum voltage deviation is 3%. This test is performed on the MAIN OUTPUT ONLY.

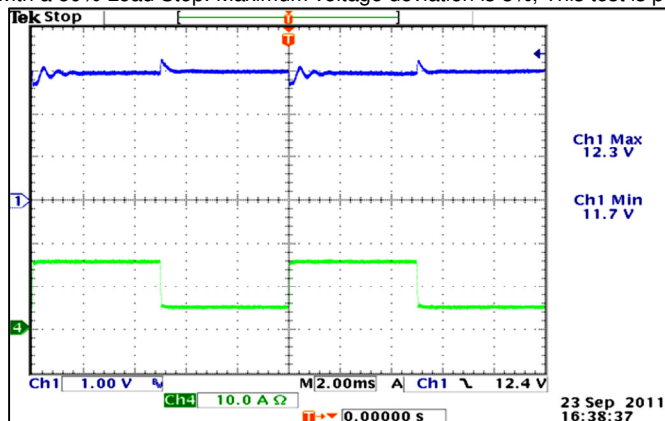

[12V OUT, 115VAC, 25% TO 75% LOAD STEP](#)

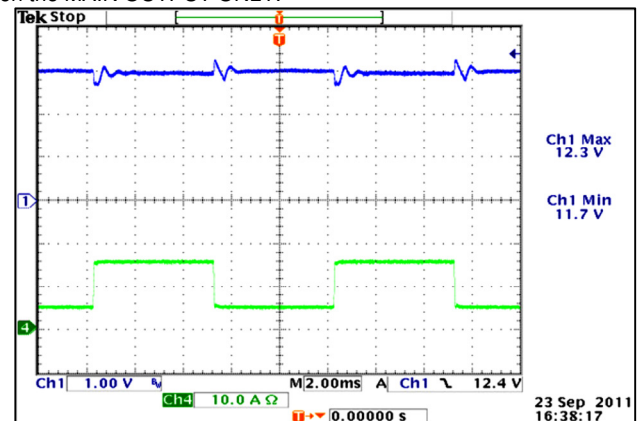

[12V OUT, 230VAC, 25% TO 75% LOAD STEP](#)

Output Overload Characteristic

Supply shall protect itself against Overload conditions. The Power Supply shall recover from Overload Conditions without operator intervention.

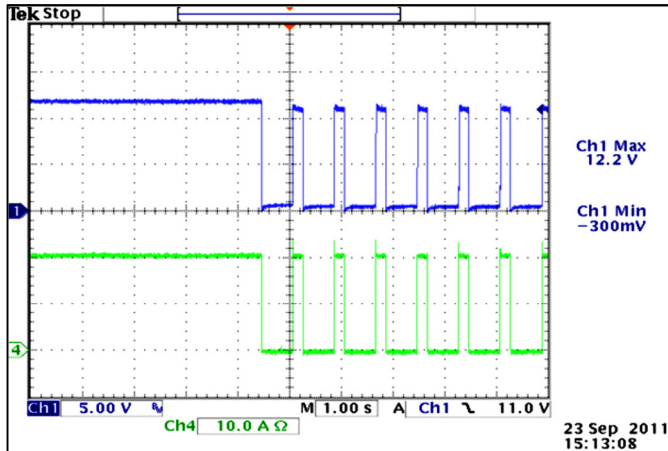

12V OUT, 90VAC

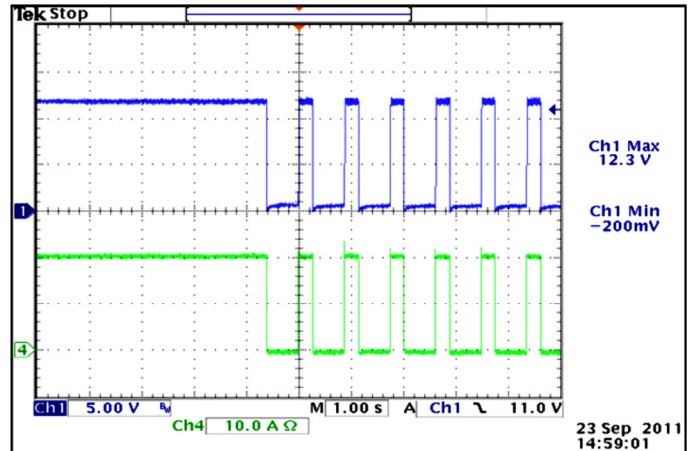

12V OUT, 264VAC

Turn-On Time

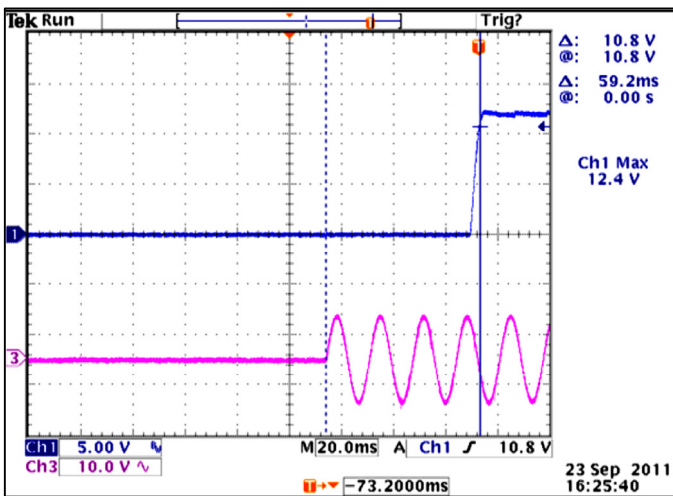

12V OUT, NO LOAD, 90VAC

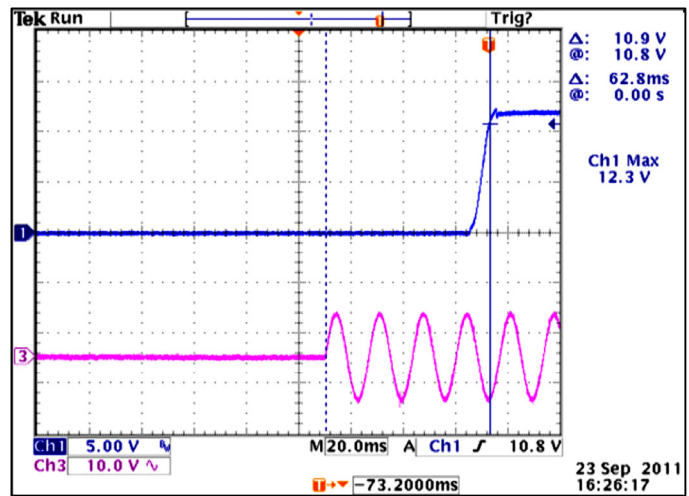

12V OUT, FULL LOAD, 90VAC

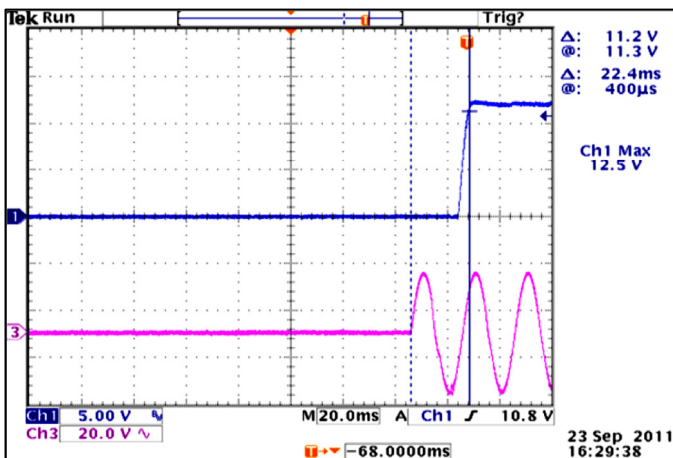

12V OUT, NO LOAD, 264VAC

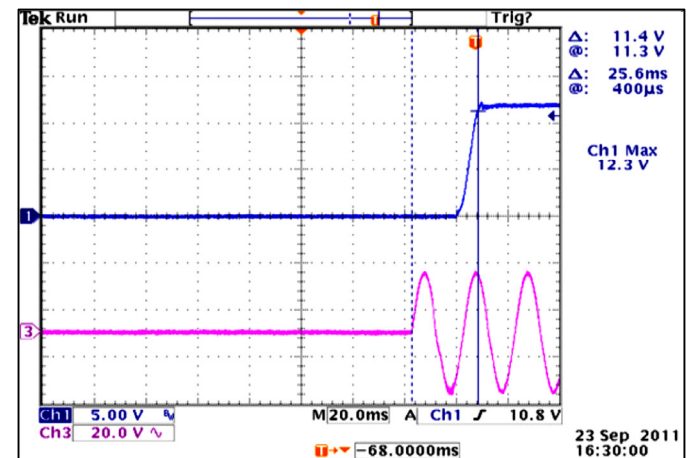

12V OUT, FULL LOAD, 264VAC