

RMC15A

RMC 15A -1 -□

① ② ③ ④

c **RoHS**

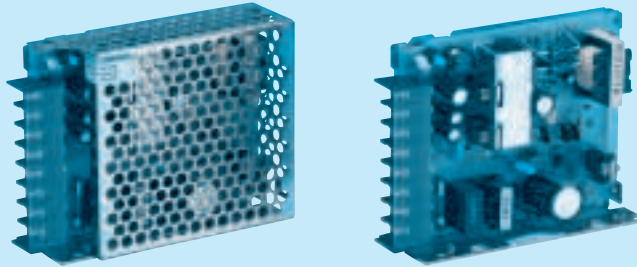

- ① Series name
- ② Output wattage
- ③ Output voltage combination
- ④ Optional *2
 C :with Coating
 G :Low leakage current
 J :Connector type
 N :with Cover

RMC

MODEL	RMC15A-1		RMC15A-2	
DC OUTPUT	V1	+5V 2.0A	+5V 2.0A	
	V2	+12V 0.3A	+15V 0.2A	
	V3	-12V 0.2A	-15V 0.2A	

SPECIFICATIONS

	MODEL	RMC15A-1			RMC15A-2			
INPUT	VOLTAGE[V]	AC85 - 132 1 φ or DC110 - 170						
	CURRENT[A]	ACIN 100V	0.45typ (Io=100%)					
	FREQUENCY[Hz]	47 - 440 or DC						
	EFFICIENCY[%]	ACIN 100V	65typ (Io=100%)					
	INRUSH CURRENT[A]	ACIN 100V	20typ (Io=100%) (At cold start)					
OUTPUT	VOLTAGE[V]	+5	+12	-12	+5	+15	-15	
	CURRENT[A]	0 - 2.0	0 - 0.3	0 - 0.2	0 - 2.0	0 - 0.2	0 - 0.2	
	LINE REGULATION[mV]	20max	48max	48max	20max	60max	60max	
	LOAD REGULATION[mV]	100max	120max	120max	100max	150max	150max	
	RIPPLE[mVp-p]	0 to +50°C *1	100max	120max	120max	100max	120max	120max
		-10 - 0°C *1	150max	160max	160max	150max	160max	160max
	RIPPLE NOISE[mVp-p]	0 to +50°C *1	120max	150max	150max	120max	150max	150max
		-10 - 0°C *1	170max	180max	180max	170max	180max	180max
	TEMPERATURE REGULATION[mV]	0 to +50°C	50max	350max	350max	50max	350max	350max
		-10 to +50°C	60max	420max	420max	60max	420max	420max
START-UP TIME[ms]	100max (ACIN 85V, Io=100%)							
HOLD-UP TIME[ms]	10typ (ACIN 85V, Io=100%, 0 to +50°C) 20typ (ACIN 100V, Io=100%, 0 to +50°C)							
OUTPUT VOLTAGE ADJUSTMENT RANGE[V]	5.00 - 5.25	Fixed	Fixed	5.00 - 5.25	Fixed	Fixed		
OUTPUT VOLTAGE SETTING[V]	—	11.40 to 12.60	-11.40 to -12.60	—	14.25 to 15.74	-14.25 to -15.75		
PROTECTION CIRCUIT	OVERCURRENT PROTECTION	Works over 105% of rating and recovers automatically						
	OVERVOLTAGE PROTECTION	By zero diode clamping (+5V only)						
	OPERATING INDICATION	LED (Green)						
ISOLATION	INPUT-OUTPUT	AC2,000V 1minute, DC500V 50MΩmin (At Room Temperature)						
	INPUT-FG, COVER	AC2,000V 1minute, DC500V 50MΩmin (At Room Temperature)						
	OUTPUT-FG, COVER	AC500V 1minute, DC500V 50MΩmin (At Room Temperature)						
	OUTPUT-OUTPUT(V1-V2,V3)	AC100V 1minute, DC100V 10MΩmin (At Room Temperature)						
ENVIRONMENT	OPERATING TEMP.,HUMID.AND ALTITUDE	-10 to +60°C, 20 - 90%RH (Non condensing) (Refer to DERATING CURVE), 3,000m (10,000feet) max						
	STORAGE TEMP.,HUMID.AND ALTITUDE	-20 to +75°C, 20 - 90%RH (Non condensing), 9,000m (30,000feet) max						
	VIBRATION	10 - 55Hz, 19.6m/s ² (2G), 3minutes period, 60minutes each along X, Y and Z axis						
	IMPACT	196.1m/s ² (20G), 11ms, once each X, Y and Z axis						
SAFETY AND NOISE REGULATIONS	AGENCY APPROVALS	UL60950-1, C-UL Complies with DEN-AN						
	CONDUCTED NOISE	Complies with FCC-B, VCCI-B						
OTHERS	CASE SIZE/WEIGHT	28 × 80 × 100mm (W × H × D) /250g max (without cover)						
	COOLING METHOD	Convection						

*1 Measured by 20MHz oscilloscope or Ripple-Noise meter(equivalent to KEISOKU-GIKEN : RM101).
 *2 Please contact us about safety approvals for the model with option.
 * Series/Parallel operation with other model is not possible.
 * When units are operated with chassis and cover, derating is required.

External view

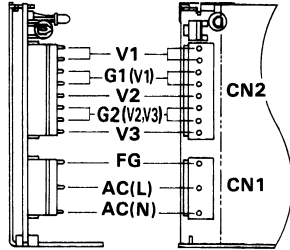

I/O Connector	Mating Connector	Terminal
CN1	B3P5-VH	VHR-5N
CN2	B8P-VH	VHR-8N

Chain: SVH-21T-P1.1
Loose: BVH-21T-P1.1
(Mfr: J.S.T.)

Connector type

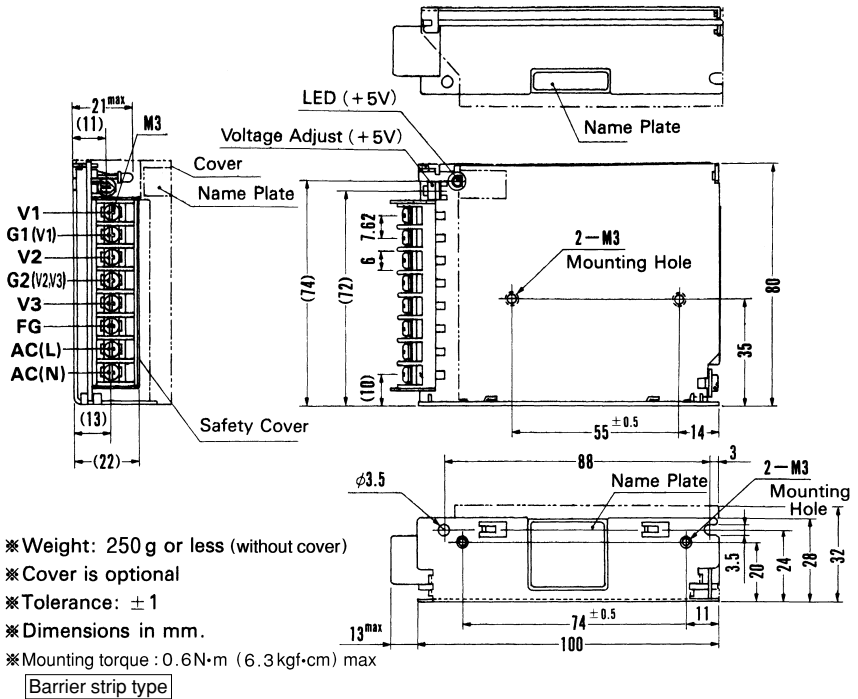

- ※ Weight: 250 g or less (without cover)
- ※ Cover is optional
- ※ Tolerance: ± 1
- ※ Dimensions in mm.
- ※ Mounting torque: 0.6N·m (6.3 kgf·cm) max

Barrier strip type

Performance data

STATIC CHARACTERISTICS (RMC15A-1)

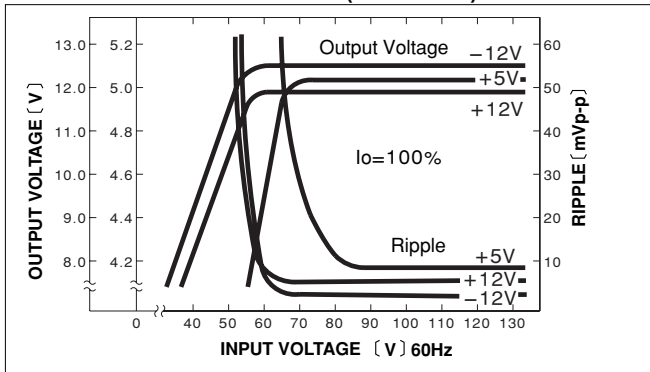

RISE TIME & FALL TIME (RMC15A-1)

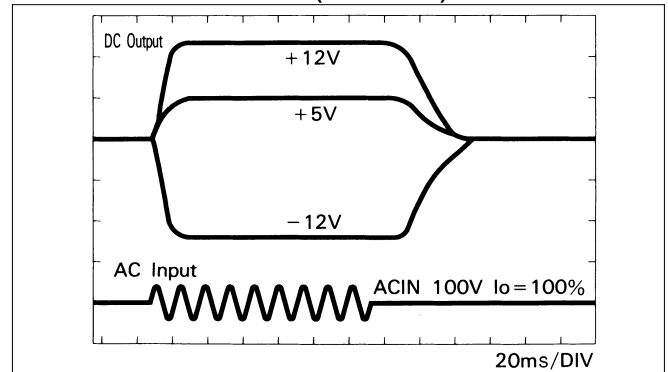

OVERCURRENT CHARACTERISTICS (RMC15A-1)

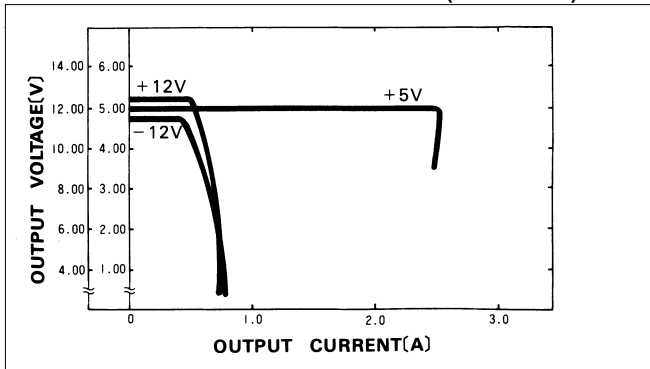

DERATING CURVE

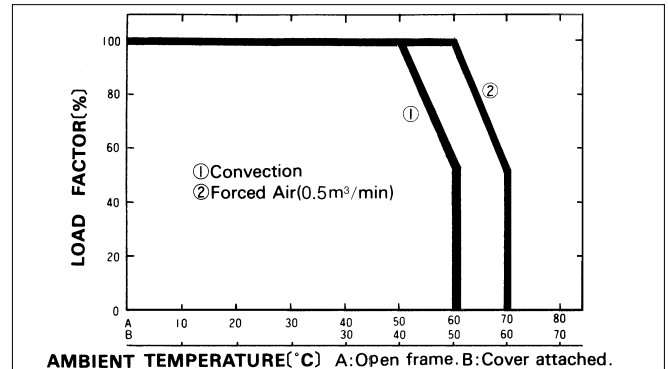

RMC30A

RMC 30A -1 -□

① ② ③ ④

RoHS

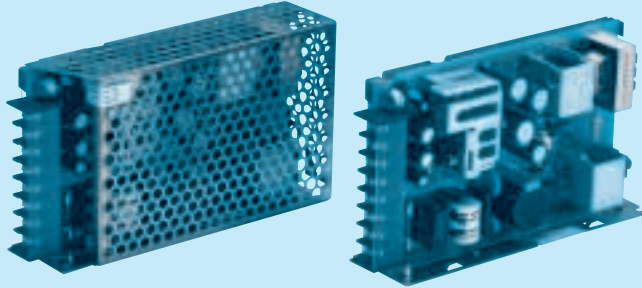

- ① Series name
- ② Output wattage
- ③ Output voltage combination
- ④ Optional *2
 G :Low leakage current
 J :Connector type
 N :with Cover

MODEL	RMC30A-1		RMC30A-2	
DC OUTPUT	V1	+5V 3.0A	+5V 3.0A	
	V2	+12V 1.2A	+15V 0.5A	
	V3	-12V 0.3A	-15V 0.5A	

SPECIFICATIONS

	MODEL	RMC30A-1			RMC30A-2			
INPUT	VOLTAGE[V]	AC85 - 132 1 φ or DC110 - 170						
	CURRENT[A]	ACIN 100V	0.9typ (Io=100%)					
	FREQUENCY[Hz]	47 - 440 or DC						
	EFFICIENCY[%]	ACIN 100V	67typ (Io=100%)					
	INRUSH CURRENT[A]	ACIN 100V	30typ (Io=100%) (At cold start)					
OUTPUT	VOLTAGE[V]	+5	+12	-12	+5	+15	-15	
	CURRENT[A]	0 - 3.0	0 - 1.2	0 - 0.3	0 - 3.0	0 - 0.5	0 - 0.5	
	LINE REGULATION[mV]	20max	48max	48max	20max	60max	60max	
	LOAD REGULATION[mV]	100max	120max	150max	100max	120max	150max	
	RIPPLE[mVp-p]	0 to +50°C *1	100max	120max	120max	100max	120max	120max
		-10 - 0°C *1	150max	160max	160max	150max	160max	160max
	RIPPLE NOISE[mVp-p]	0 to +50°C *1	120max	150max	150max	120max	150max	150max
		-10 - 0°C *1	170max	180max	180max	170max	180max	180max
	TEMPERATURE REGULATION[mV]	0 to +50°C	50max	350max	350max	50max	350max	350max
		-10 to +50°C	60max	420max	420max	60max	420max	420max
START-UP TIME[ms]	100max (ACIN 85V, Io=100%)							
HOLD-UP TIME[ms]	10typ (ACIN 85V, Io=100%, 0 to +50°C) 20typ (ACIN 100V, Io=100%, 0 to +50°C)							
OUTPUT VOLTAGE ADJUSTMENT RANGE[V]	5.00 - 5.25	Fixed	Fixed	5.00 - 5.25	Fixed	Fixed		
OUTPUT VOLTAGE SETTING[V]	—	11.40 to 12.60	-11.40 to -12.60	—	14.25 to 15.75	-14.25 to -15.75		
PROTECTION CIRCUIT	OVERCURRENT PROTECTION	Works over 105% of rating and recovers automatically						
	OVERVOLTAGE PROTECTION	Works at 115 - 140% of rating (+5V)						
	OPERATING INDICATION	LED (Green)						
ISOLATION	INPUT-OUTPUT	AC2,000V 1minute, DC500V 50MΩmin (At Room Temperature)						
	INPUT-FG, COVER	AC2,000V 1minute, DC500V 50MΩmin (At Room Temperature)						
	OUTPUT-FG, COVER	AC500V 1minute, DC500V 50MΩmin (At Room Temperature)						
	OUTPUT-OUTPUT(V1-V2,V3)	AC100V 1minute, DC100V 10MΩmin (At Room Temperature)						
ENVIRONMENT	OPERATING TEMP.,HUMID.AND ALTITUDE	-10 to +60°C, 20 - 90%RH (Non condensing) (Refer to DERATING CURVE), 3,000m (10,000feet) max						
	STORAGE TEMP.,HUMID.AND ALTITUDE	-20 to +75°C, 20 - 90%RH (Non condensing), 9,000m (30,000feet) max						
	VIBRATION	10 - 55Hz, 19.6m/s ² (2G), 3minutes period, 60minutes each along X, Y and Z axis						
	IMPACT	196.1m/s ² (20G), 11ms, once each X, Y and Z axis						
SAFETY AND NOISE REGULATIONS	AGENCY APPROVALS	UL60950-1, C-UL Complies with DEN-AN						
	CONDUCTED NOISE	Complies with FCC-B, VCCI-B						
OTHERS	CASE SIZE/WEIGHT	31 × 80 × 135mm (W × H × D)/350g max (without cover)						
	COOLING METHOD	Convection						

*1 Measured by 20MHz oscilloscope or Ripple-Noise meter(equivalent to KEISOKU-GIKEN : RM101).
 *2 Please contact us about safety approvals for the model with option.
 * Series/Parallel operation with other model is not possible.
 * When units are operated with chassis and cover, derating is required.

External view

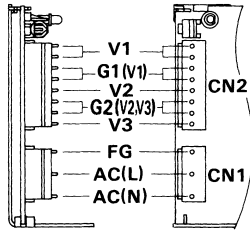

I/O Connector	Mating Connector	Terminal
CN1	B3P5-VH	VHR-5N
CN2	B8P-VH	VHR-8N

Chain : SVH-21T-P1.1
Loose: BVH-21T-P1.1
(Mfr: J.S.T.)

Connector type

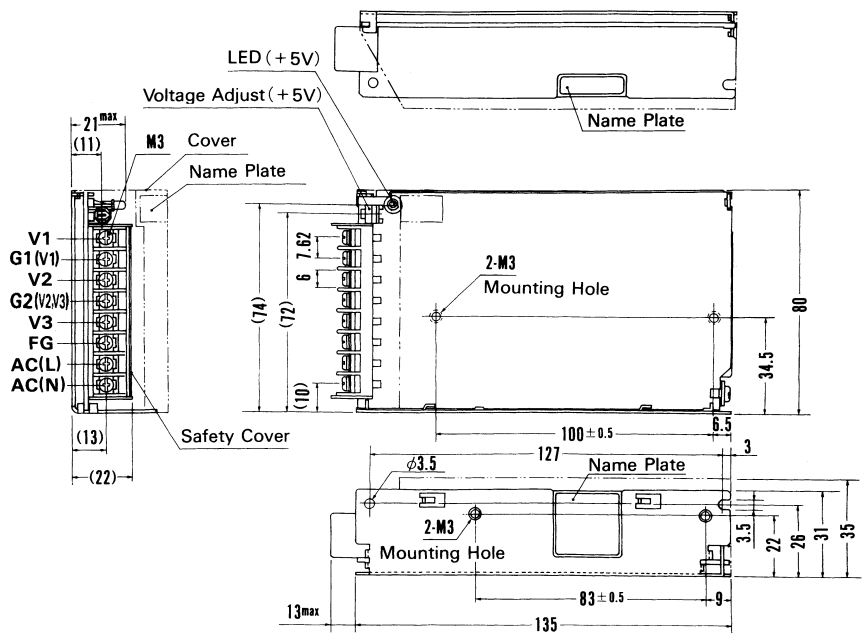

Barrier strip type

- *Weight: 350g or less (without cover) *Cover is optional
- *Tolerance: ± 1 *Dimensions in mm.
- *Mounting torque : 0.6N·m (6.3kgf·cm) max

Performance data

STATIC CHARACTERISTICS (RMC30A-1)

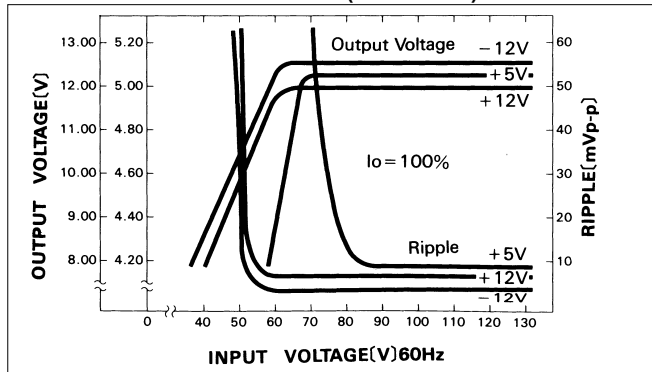

RISE TIME & FALL TIME (RMC30A-1)

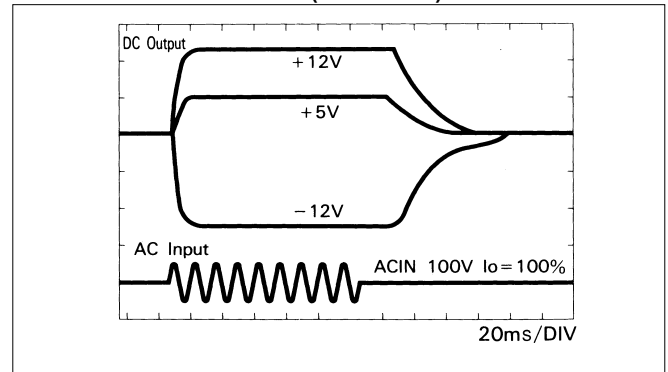

OVERCURRENT CHARACTERISTICS (RMC30A-1)

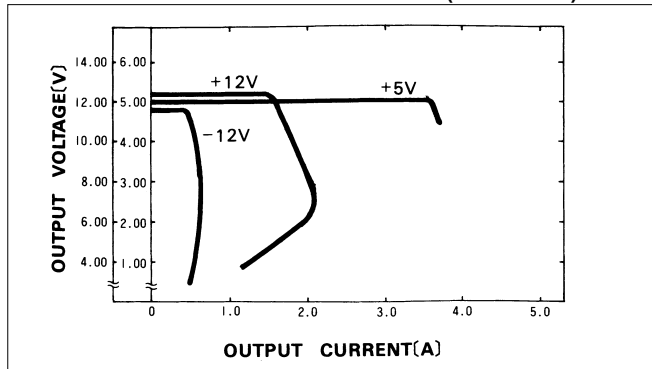

DERATING CURVE

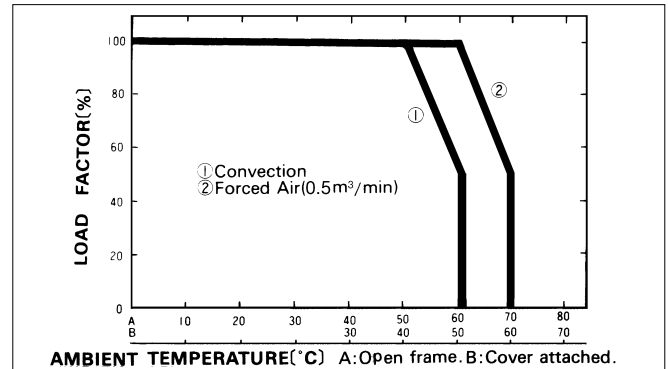

RMC50A

RMC 50A -1 -□

① ② ③ ④

RoHS

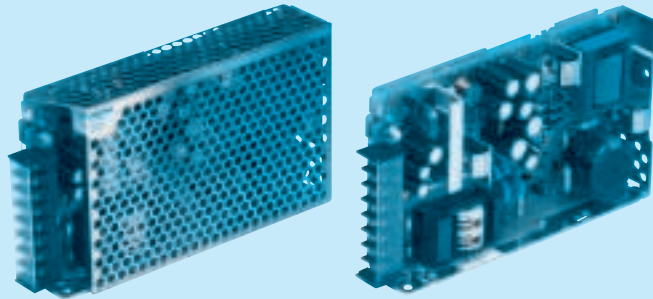

- ① Series name
- ② Output wattage
- ③ Output voltage combination
- ④ Optional *3
- C :with Coating
- G :Low leakage current
- J :Connector type
- N :with Cover

MODEL	RMC50A-1		RMC50A-2	
DC OUTPUT	V1	+5V 5.0A	+5V 5.0A	
	V2	+12V 1.5(Peak 2)A	+15V 1.2A	
	V3	-12V 0.5A	-15V 0.5A	

SPECIFICATIONS

	MODEL	RMC50A-1			RMC50A-2			
INPUT	VOLTAGE[V]	AC85 - 132 1 φ or DC110 - 170						
	CURRENT[A]	ACIN 100V	1.5typ (Io=100%)					
	FREQUENCY[Hz]	47 - 440 or DC						
	EFFICIENCY[%]	ACIN 100V	70typ (Io=100%)					
	INRUSH CURRENT[A]	ACIN 100V	30typ (Io=100%) (At cold start)					
OUTPUT	VOLTAGE[V]	+5	+12	-12	+5	+15	-15	
	CURRENT[A]	*1 0 - 5.0	0 - 1.5 (Peak 2)	0 - 0.5	0 - 5.0	0 - 1.2	0 - 0.5	
	LINE REGULATION[mV]	20max	48max	48max	20max	60max	60max	
	LOAD REGULATION[mV]	40max	150max	150max	40max	150max	150max	
	RIPPLE[mVp-p]	0 to +50°C *2	80max	120max	120max	80max	120max	120max
		-10 - 0°C *2	140max	160max	160max	140max	160max	160max
	RIPPLE NOISE[mVp-p]	0 to +50°C *2	120max	150max	150max	120max	150max	150max
		-10 - 0°C *2	160max	180max	180max	160max	180max	180max
	TEMPERATURE REGULATION[mV]	0 to +50°C	50max	350max	350max	50max	350max	350max
		-10 to +50°C	60max	420max	420max	60max	420max	420max
START-UP TIME[ms]	100max (ACIN 85V, Io=100%)							
HOLD-UP TIME[ms]	10typ (ACIN 85V, Io=100%, 0 to +50°C) 20typ (ACIN 100V, Io=100%, 0 to +50°C)							
OUTPUT VOLTAGE ADJUSTMENT RANGE[V]	5.00 - 5.25	Fixed	Fixed	5.00 - 5.25	Fixed	Fixed		
OUTPUT VOLTAGE SETTING[V]	—	11.40 to 12.60	-11.40 to -12.60	—	14.25 to 15.75	-14.25 to -15.75		
PROTECTION CIRCUIT	OVERCURRENT PROTECTION	Works over 105% of rating and recovers automatically						
	OVERVOLTAGE PROTECTION	Works at 115 - 140% of rating (+5V)						
	OPERATING INDICATION	LED (Green)						
ISOLATION	INPUT-OUTPUT	AC2,000V 1minute, DC500V 50MΩmin (At Room Temperature)						
	INPUT-FG, COVER	AC2,000V 1minute, DC500V 50MΩmin (At Room Temperature)						
	OUTPUT-FG, COVER	AC500V 1minute, DC500V 50MΩmin (At Room Temperature)						
	OUTPUT-OUTPUT(V1-V2,V3)	AC100V 1minute, DC100V 10MΩmin (At Room Temperature)						
ENVIRONMENT	OPERATING TEMP.,HUMID.AND ALTITUDE	-10 to +65°C, 20 - 90%RH (Non condensing) (Refer to DERATING CURVE), 3,000m (10,000feet) max						
	STORAGE TEMP.,HUMID.AND ALTITUDE	-20 to +75°C, 20 - 90%RH (Non condensing), 9,000m (30,000feet) max						
	VIBRATION	10 - 55Hz, 19.6m/s ² (2G), 3minutes period, 60minutes each along X, Y and Z axis						
	IMPACT	196.1m/s ² (20G), 11ms, once each X, Y and Z axis						
SAFETY AND NOISE REGULATIONS	AGENCY APPROVALS	UL60950-1, C-UL Complies with DEN-AN						
	CONDUCTED NOISE	Complies with FCC-B, VCCI-B						
OTHERS	CASE SIZE/WEIGHT	31 × 93 × 155mm (W × H × D) /350g max (without cover)						
	COOLING METHOD	Convection						

*1 Peak load current of V2 for RMC50A-1 is possible to draw 30 seconds.
 *2 Measured by 20MHz oscilloscope or Ripple-Noise meter(equivalent to KEISOKU-GIKEN : RM101).
 *3 Please contact us about safety approvals for the model with option.
 * Series/Parallel operation with other model is not possible.
 * When units are operated with chassis and cover, derating is required.

External view

RMC

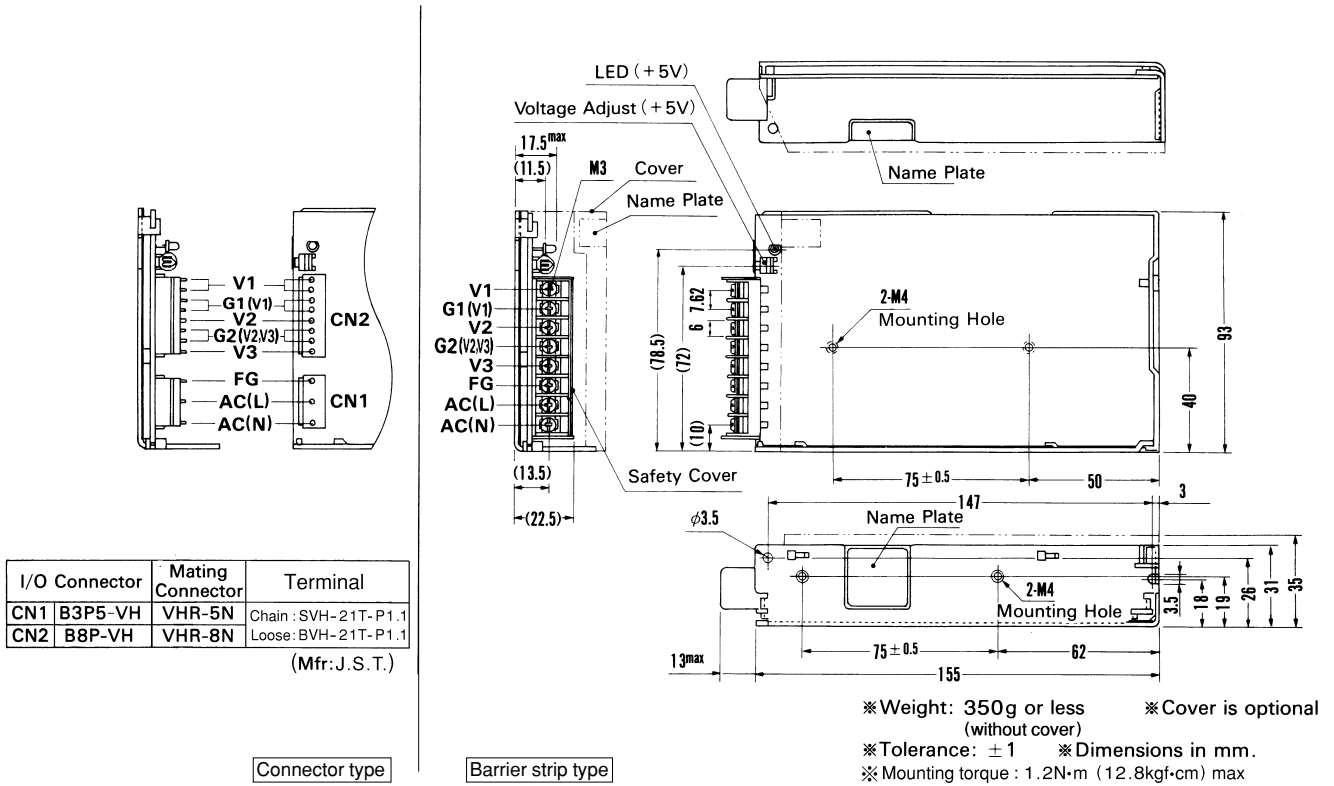

Performance data

STATIC CHARACTERISTICS (RMC50A-1)

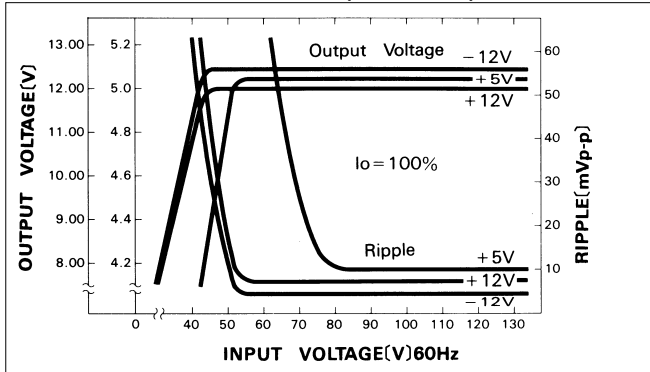

RISE TIME & FALL TIME (RMC50A-1)

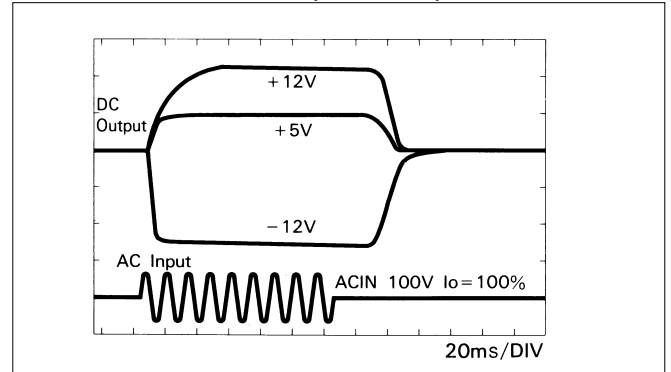

OVERCURRENT CHARACTERISTICS (RMC50A-1)

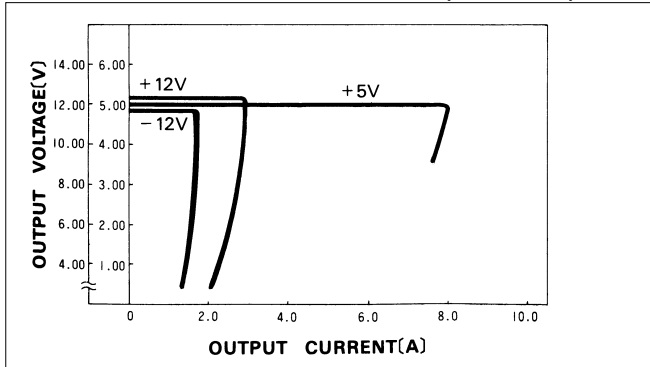

DERATING CURVE

