

## Cree® XLamp® XB-D LEDs



### PRODUCT DESCRIPTION

The XLamp® XB-D LED brings next-generation performance, price and size to all LED lighting applications. The XB-D's footprint enables smaller designs with densely packed arrays for better light mixing and concentration.

The XB-D shares common footprint and uniform package design across all white and color configurations, simplifying board and optical designs for many LED systems. The XB-D is optimized to dramatically lower system cost in any illumination application, from indoor and outdoor lighting to architectural and transportation lighting.

### FEATURES

- Cree's smallest lighting class LED: 2.45 X 2.45 mm
- XB-D white binned @ 85 °C; XB-D color binned @ 25 °C
- Up to 136 lm/W in cool white (@ 85 °C, 350 mA)
- Available in white, 80-minimum CRI white, and 70-minimum CRI cool white, royal blue, blue, green, amber, red-orange & red
- 1 A maximum drive current
- Wide viewing angle: from 115° (white) to 140° (red)
- Reflow solderable - JEDEC J-STD-020C compatible
- Unlimited floor life at ≤ 30 °C/85% RH
- Electrically neutral thermal path
- RoHS and REACH compliant
- UL® recognized component (E349212)

### TABLE OF CONTENTS

Characteristics .....	2
Flux Characteristics .....	3
Relative Spectral Power Distribution ....	6
Relative Flux vs. Junction Temperature .....	7
Electrical Characteristics .....	8
Relative Flux vs. Current .....	9
Relative Chromaticity vs. Current .....	10
Relative Chromaticity vs. Temperature .....	11
Typical Spatial Distribution .....	11
Thermal Design .....	12
Reflow Soldering Characteristics .....	13
Notes .....	14
Mechanical Dimensions .....	16
Tape and Reel .....	18
Packaging .....	19



## CHARACTERISTICS

Characteristics	Unit	Minimum	Typical	Maximum
Thermal resistance, junction to solder point - white, royal blue, blue	°C/W		6.5	
Thermal resistance, junction to solder point - green	°C/W		11	
Thermal resistance, junction to solder point - amber	°C/W		7	
Thermal resistance, junction to solder point - red-orange, red	°C/W		5	
Viewing angle (FWHM) - white	degrees		115	
Viewing angle (FWHM) - royal blue, blue, green	degrees		135	
Viewing angle (FWHM) - amber, red-orange, red	degrees		140	
Temperature coefficient of voltage - white	mV/°C		-2.5	
Temperature coefficient of voltage - royal blue, blue, green	mV/°C		-3.3	
Temperature coefficient of voltage - amber, red-orange, red	mV/°C		-2	
ESD withstand voltage (HBM per Mil-Std-883D) - white, royal blue, blue, green	V			8000
ESD classification (HBM per Mil-Std-883D) - amber, red-orange, red			Class 2	
DC forward current	mA			1000
Reverse voltage	V			-5
Forward voltage (@ 350 mA, 85 °C) - white	V		2.9	3.5
Forward voltage (@ 350 mA, 25 °C) - royal blue, blue	V		3.1	3.7
Forward voltage (@ 350 mA, 25 °C) - green	V		3.3	3.9
Forward voltage (@ 350 mA, 25 °C) - amber, red-orange, red	V		2.25	2.6
LED junction temperature	°C			150

## FLUX CHARACTERISTICS - WHITE ( $T_J = 85\text{ }^\circ\text{C}$ )

The following table provides several base order codes for XLamp XB-D LEDs. It is important to note that the base order codes listed here are a subset of the total available order codes for the product family. For more order codes, as well as a complete description of the order code nomenclature, please consult the XLamp XB-D LED Binning and Labeling document.

Color	CCT Range		Minimum Luminous Flux @ 350 mA			Calculated Minimum Luminous Flux (lm)**		Order Code
	Minimum	Maximum	Group	Flux (lm) @ 85 °C	Flux (lm) @ 25 °C*	700 mA	1000 mA	
Cool White	5000 K	8300 K	R3	122	139	210	271	XBDAWT-00-0000-000000F51
			R2	114	130	196	253	XBDAWT-00-0000-000000E51
70 CRI Minimum Cool White	5000 K	8300 K	R3	122	139	210	271	XBDAWT-00-0000-000000BF51
			R2	114	130	196	253	XBDAWT-00-0000-000000BE51
Neutral White	3700 K	5000 K	R2	114	130	196	253	XBDAWT-00-0000-000000LEE4
			Q5	107	122	184	237	XBDAWT-00-0000-000000LDE4
			Q4	100	114	172	222	XBDAWT-00-0000-000000LCE4
80 CRI Minimum White	2600 K	6200 K	Q4	100	114	172	222	XBDAWT-00-0000-000000HCE7
			Q3	93.9	107	162	208	XBDAWT-00-0000-000000HBE7
			Q2	87.4	100	150	194	XBDAWT-00-0000-000000HAE7
Warm White	2600 K	3700 K	Q4	100	114	172	222	XBDAWT-00-0000-000000LCE7
			Q3	93.9	107	162	208	XBDAWT-00-0000-000000LBE7
			Q2	87.4	100	150	194	XBDAWT-00-0000-000000LAE7

### Notes:

- Cree maintains a tolerance of  $\pm 7\%$  on flux and power measurements,  $\pm 0.005$  on chromaticity (CCx, CCy) measurements and  $\pm 2$  on CRI measurements. See the Measurements section (page 14).
- Typical CRI for Neutral White, 3700 K - 5000K CCT is 75.
- Typical CRI for Warm White, 2600 K - 3700 K CCT is 80.
- Minimum CRI for 70 CRI Minimum Cool White is 70.
- Minimum CRI for 80 CRI Minimum White is 80.
- \* Flux values @ 25 °C are calculated and are for reference only.
- \*\* Calculated flux values at 700 mA and 1000 mA are for 85 °C and are for reference only.

## FLUX CHARACTERISTICS - COLOR ( $T_j = 25\text{ }^\circ\text{C}$ )

The following tables provide several base order codes for XLamp XB-D LEDs. It is important to note that the base order codes listed here are a subset of the total available order codes for the product family. For more order codes, as well as a complete description of the order-code nomenclature, please consult the XLamp XB-D LED Binning and Labeling document.

Color	Dominant Wavelength Range				Minimum Radiant Flux (mW) @ 350 mA		Order Code
	Minimum		Maximum		Group	Flux (mW)	
	Group	DWL (nm)	Group	DWL (nm)			
Royal Blue	D36	450	D57	465	34 (N)	550	XBDROY-00-0000-000000N01
					33 (M)	525	XBDROY-00-0000-000000M01
					32 (L)	500	XBDROY-00-0000-000000L01
					31 (K)	475	XBDROY-00-0000-000000K01
					30 (J)	450	XBDROY-00-0000-000000J01

Color	Dominant Wavelength Range				Minimum Luminous Flux (lm) @ 350 mA		Order Code
	Minimum		Maximum		Group	Flux (lm)	
	Group	DWL (nm)	Group	DWL (nm)			
Blue	B3	465	B6	485	M2	39.8	XBDBLU-00-0000-000000201
					K3	35.2	XBDBLU-00-0000-000000Z01
					K2	30.6	XBDBLU-00-0000-000000Y01

Color	Dominant Wavelength Range				Minimum Luminous Flux (lm) @ 350 mA		Order Code
	Minimum		Maximum		Group	Flux (lm)	
	Group	DWL (nm)	Group	DWL (nm)			
Green	G2	520	G4	535	Q5	107	XBDGRN-00-0000-000000D01
					Q4	100	XBDGRN-00-0000-000000C01
					Q3	93.9	XBDGRN-00-0000-000000B01
					Q2	87.4	XBDGRN-00-0000-000000A01

Color	Dominant Wavelength Range				Minimum Luminous Flux (lm) @ 350 mA		Order Code
	Minimum		Maximum		Group	Flux (lm)	
	Group	DWL (nm)	Group	DWL (nm)			
Amber	A2	585	A3	595	P3	73.9	XBDAMB-00-0000-000000801
					P2	67.2	XBDAMB-00-0000-000000701
					N4	62	XBDAMB-00-0000-000000601
					N3	56.8	XBDAMB-00-0000-000000501

**FLUX CHARACTERISTICS - COLOR (T<sub>j</sub> = 25 °C) - CONTINUED**

Color	Dominant Wavelength Range				Minimum Luminous Flux (lm) @ 350 mA		Order Code
	Minimum		Maximum		Group	Flux (lm)	
	Group	DWL (nm)	Group	DWL (nm)			
Red-Orange	O3	610	O4	620	Q4	100	XBDRDO-00-0000-000000C01
					Q3	93.9	XBDRDO-00-0000-000000B01
					Q2	87.4	XBDRDO-00-0000-000000A01
					P4	80.6	XBDRDO-00-0000-000000901
					P3	73.9	XBDRDO-00-0000-000000801

Color	Dominant Wavelength Range				Minimum Luminous Flux (lm) @ 350 mA		Order Code
	Minimum		Maximum		Group	Flux (lm)	
	Group	DWL (nm)	Group	DWL (nm)			
Red	R2	620	R3	630	P2	67.2	XBDRDO-00-0000-000000701
					N4	62	XBDRDO-00-0000-000000601
					N3	56.8	XBDRDO-00-0000-000000501

Note: Cree maintains a tolerance of ±7% on flux and power measurements and ±1 nm on dominant wavelength measurements. See the Measurements section (page 14).

**RELATIVE SPECTRAL POWER DISTRIBUTION**

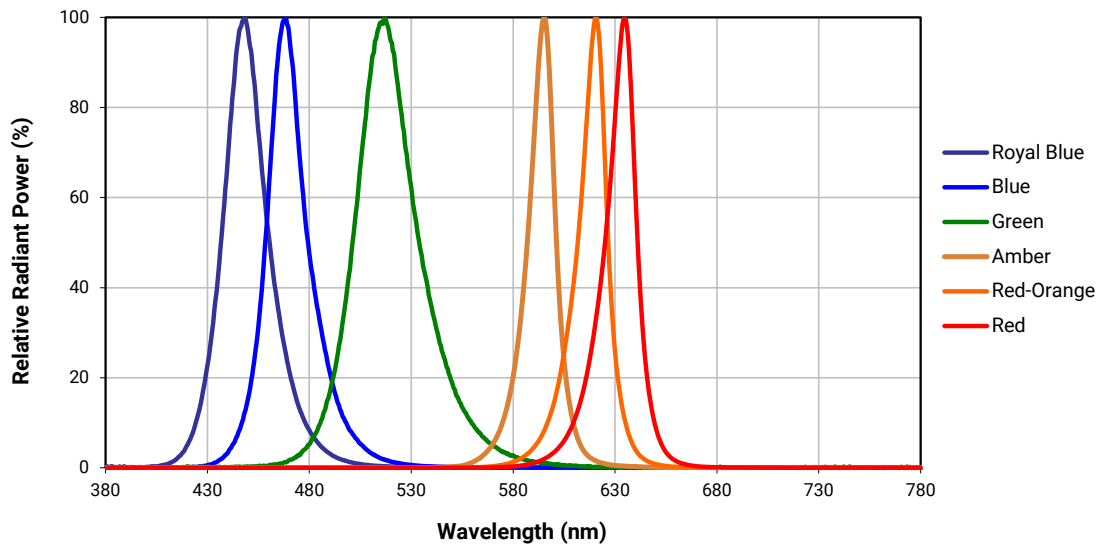

**RELATIVE FLUX VS. JUNCTION TEMPERATURE ( $I_F = 350$  mA)**



**ELECTRICAL CHARACTERISTICS ( $T_j = 85\text{ }^\circ\text{C}$ )**



**ELECTRICAL CHARACTERISTICS ( $T_j = 25\text{ }^\circ\text{C}$ )**





**RELATIVE FLUX VS. CURRENT ( $T_j = 85\text{ }^\circ\text{C}$ )**

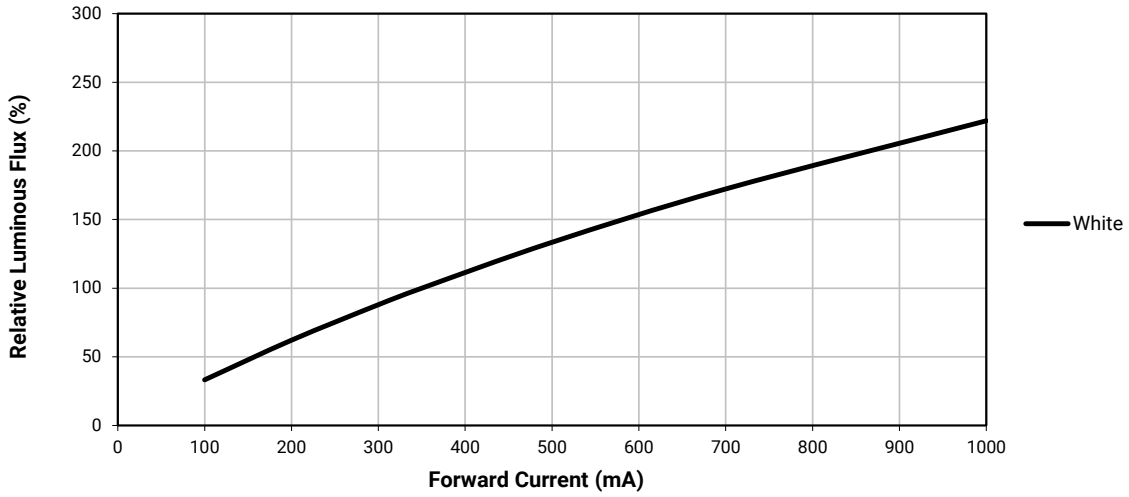

**RELATIVE FLUX VS. CURRENT ( $T_j = 25\text{ }^\circ\text{C}$ )**

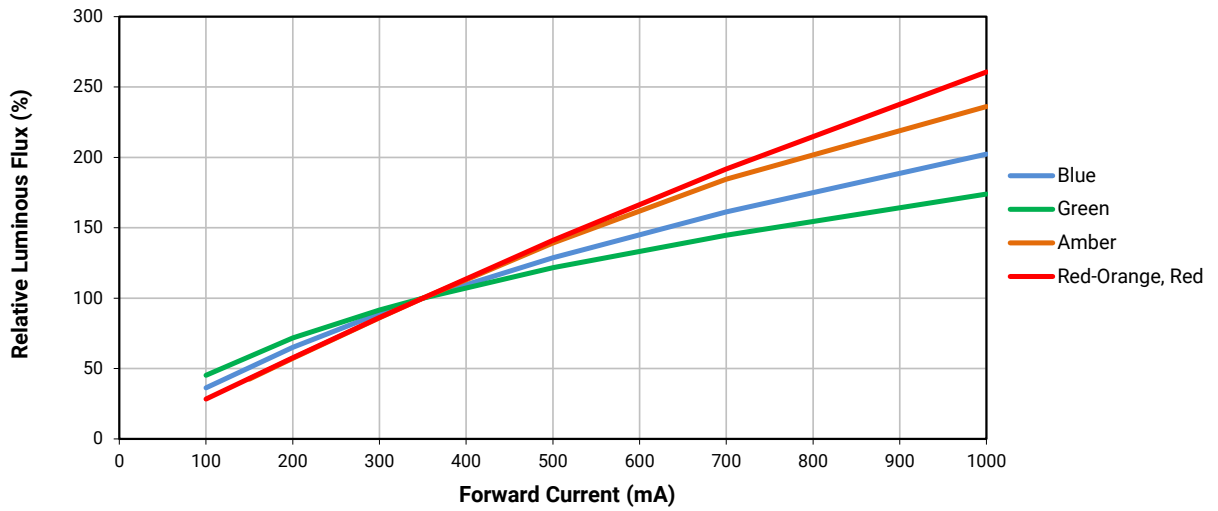

**RELATIVE FLUX VS. CURRENT ( $T_J = 25\text{ }^\circ\text{C}$ ) - CONTINUED**



**RELATIVE CHROMATICITY VS. CURRENT (WARM WHITE)**



**RELATIVE CHROMATICITY VS. TEMPERATURE (WARM WHITE)**

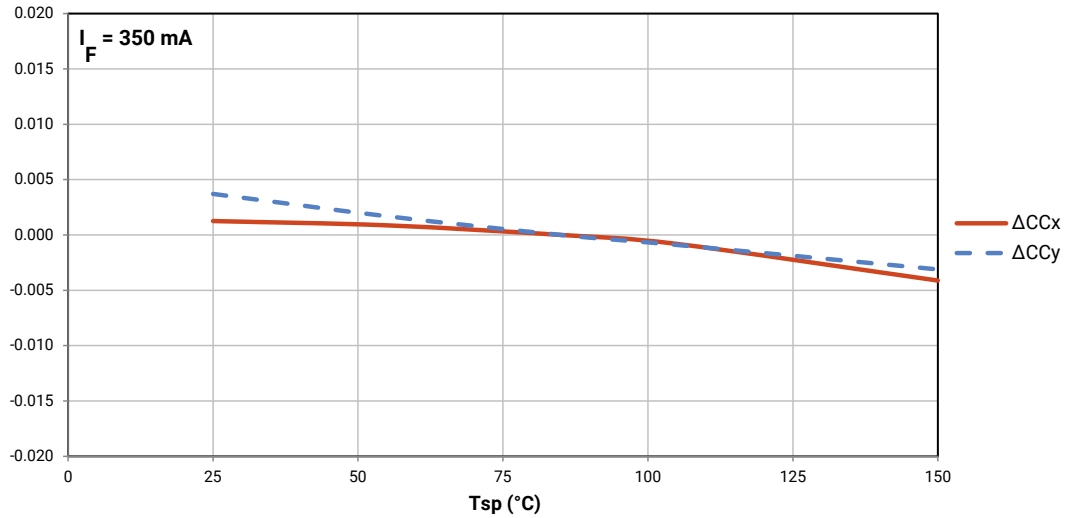

**TYPICAL SPATIAL DISTRIBUTION**

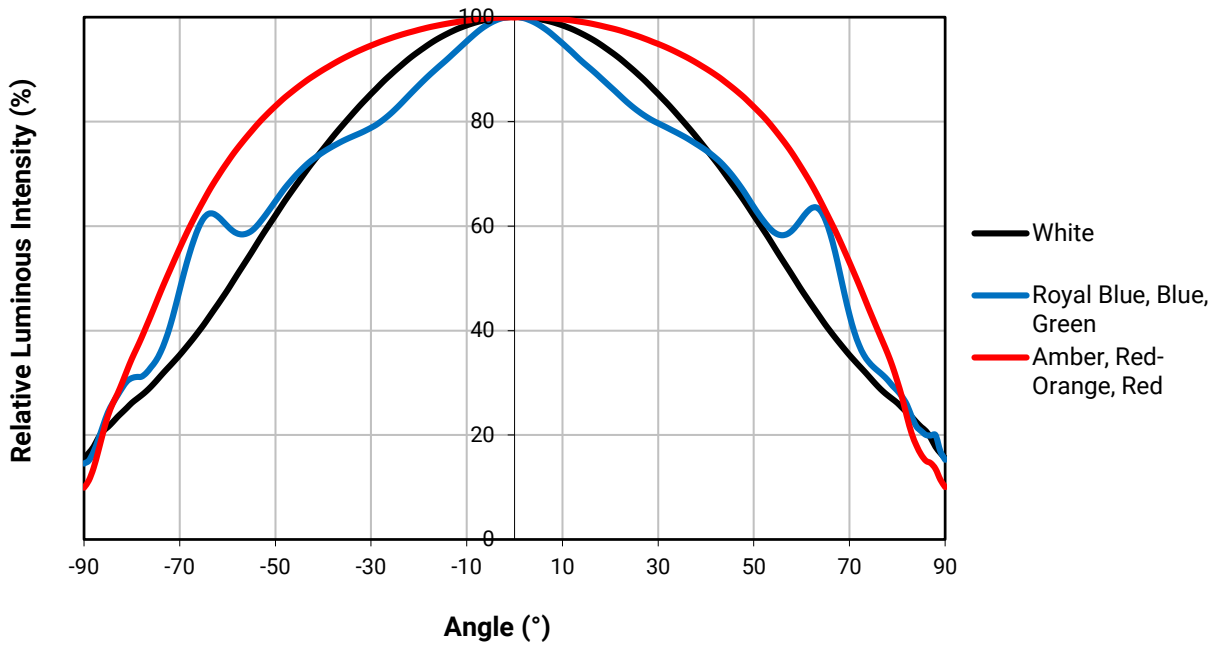

**THERMAL DESIGN**

The maximum forward current is determined by the thermal resistance between the LED junction and ambient. It is crucial for the end product to be designed in a manner that minimizes the thermal resistance from the solder point to ambient in order to optimize lamp life and optical characteristics.

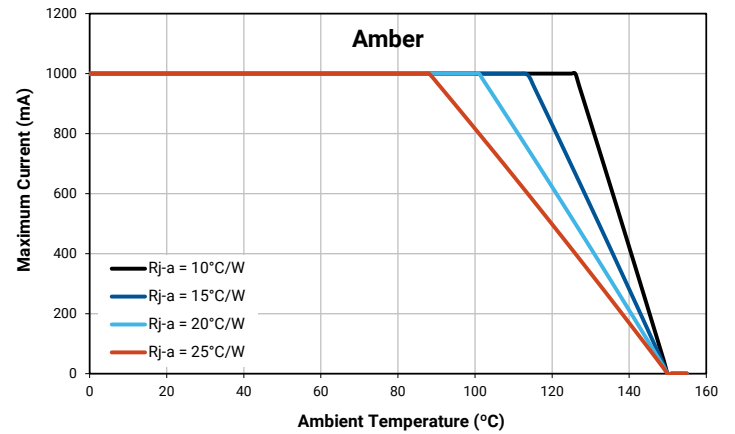
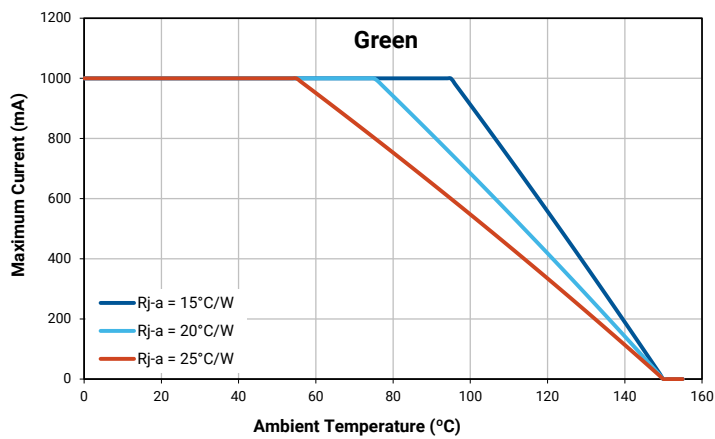
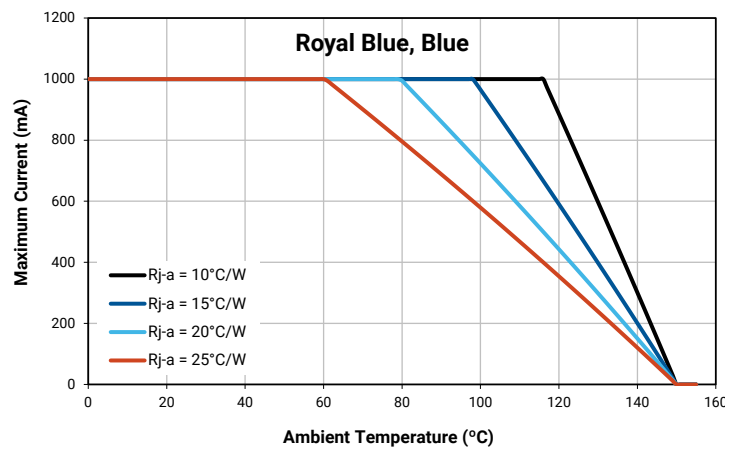
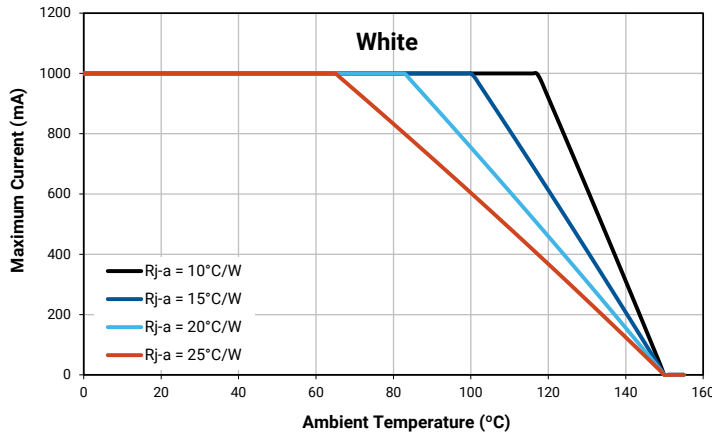

**REFLOW SOLDERING CHARACTERISTICS**

In testing, Cree has found XLamp XB-D LEDs to be compatible with JEDEC J-STD-020C, using the parameters listed below. As a general guideline, Cree recommends that users follow the recommended soldering profile provided by the manufacturer of the solder paste used.

Note that this general guideline may not apply to all PCB designs and configurations of reflow soldering equipment.



IPC/JEDEC J-STD-020C

Profile Feature	Lead-Free Solder
Average Ramp-Up Rate ( $T_{s_{max}}$ to $T_p$ )	1.2 °C/second
Preheat: Temperature Min ( $T_{s_{min}}$ )	120 °C
Preheat: Temperature Max ( $T_{s_{max}}$ )	170 °C
Preheat: Time ( $t_{s_{min}}$ to $t_{s_{max}}$ )	65-150 seconds
Time Maintained Above: Temperature ( $T_L$ )	217 °C
Time Maintained Above: Time ( $t_t$ )	45-90 seconds
Peak/Classification Temperature ( $T_p$ )	235 - 245 °C
Time Within 5 °C of Actual Peak Temperature ( $t_p$ )	20-40 seconds
Ramp-Down Rate	1 - 6 °C/second
Time 25 °C to Peak Temperature	4 minutes max.

Note: All temperatures refer to topside of the package, measured on the package body surface.

## NOTES

---

### Measurements

The luminous flux, radiant power, chromaticity, forward voltage and CRI measurements in this document are binning specifications only and solely represent product measurements as of the date of shipment. These measurements will change over time based on a number of factors that are not within Cree's control and are not intended or provided as operational specifications for the products. Calculated values are provided for informational purposes only and are not intended as specifications.

### Pre-Release Qualification Testing

Please read the [LED Reliability Overview](#) for details of the qualification process Cree applies to ensure long-term reliability for XLamp LEDs and details of Cree's pre-release qualification testing for XLamp LEDs.

### Lumen Maintenance

Cree now uses standardized IES LM-80-08 and TM-21-11 methods for collecting long-term data and extrapolating LED lumen maintenance. For information on the specific LM-80 data sets available for this LED, refer to the public [LM-80 results document](#).

Please read the [Long-Term Lumen Maintenance application note](#) for more details on Cree's lumen maintenance testing and forecasting. Please read the [Thermal Management application note](#) for details on how thermal design, ambient temperature, and drive current affect the LED junction temperature.

### Moisture Sensitivity

Cree recommends keeping XLamp LEDs in the provided, resealable moisture-barrier packaging (MBP) until immediately prior to soldering. Unopened MBPs that contain XLamp LEDs do not need special storage for moisture sensitivity.

Once the MBP is opened, XLamp XB-D LEDs may be stored as MSL 1 per JEDEC J-STD-033, meaning they have unlimited floor life in conditions of  $\leq 30$  °C/85% relative humidity (RH). Regardless of storage condition, Cree recommends sealing any unsoldered LEDs in the original MBP.

### RoHS Compliance

The levels of RoHS restricted materials in this product are below the maximum concentration values (also referred to as the threshold limits) permitted for such substances, or are used in an exempted application, in accordance with EU Directive 2011/65/EC (RoHS2), as implemented January 2, 2013. RoHS Declarations for this product can be obtained from your Cree representative or from the [Product Ecology](#) section of the Cree website.

### REACH Compliance

REACH substances of very high concern (SVHCs) information is available for this product. Since the European Chemical Agency (ECHA) has published notice of their intent to frequently revise the SVHC listing for the foreseeable future, please contact a Cree representative to insure you get the most up-to-date REACH SVHC Declaration. REACH banned substance information (REACH Article 67) is also available upon request.

**NOTES - CONTINUED**

---

**UL® Recognized Component**

Level 4 enclosure consideration. The LED package or a portion thereof has been investigated as a fire and electrical enclosure per ANSI/UL 8750.

**Vision Advisory**

WARNING: Do not look at an exposed lamp in operation. Eye injury can result. For more information about LEDs and eye safety, please refer to the [LED Eye Safety application note](#).

**MECHANICAL DIMENSIONS**

Thermal vias, if present, are not shown on these drawings.

All measurements are  $\pm 0.13$  mm unless otherwise indicated.



**Top View**



**Side View**



**Bottom View**



**Alternate Bottom View**



**Alternate Bottom View**



**MECHANICAL DIMENSIONS - CONTINUED**



**Recommended PCB Solder Pad**



**Recommended Stencil Pattern  
(Hatched Area is Opening)**

**TAPE AND REEL**

All Cree carrier tapes conform to EIA-481D, Automated Component Handling Systems Standard.

Except as noted, all dimensions in mm



**PACKAGING**

---

**Unpackaged Reel**

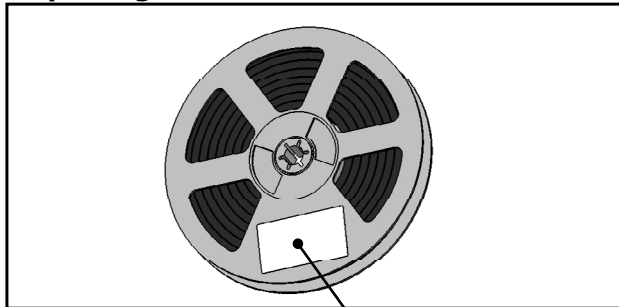

Label with Cree Bin Code,  
Quantity, Reel ID

**Packaged Reel**

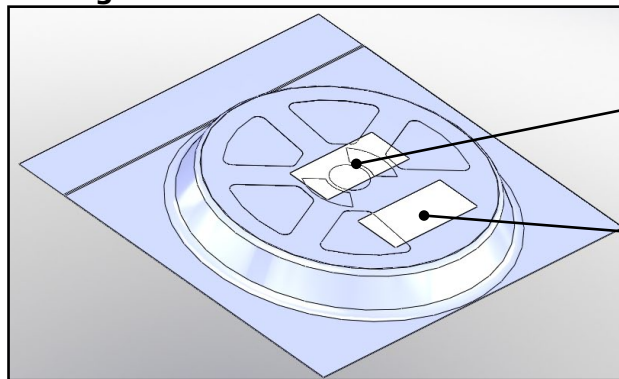

Label with Cree Order Code,  
Quantity, Reel ID, PO #

Label with Cree Bin Code,  
Quantity, Reel ID

**Boxed Reel**

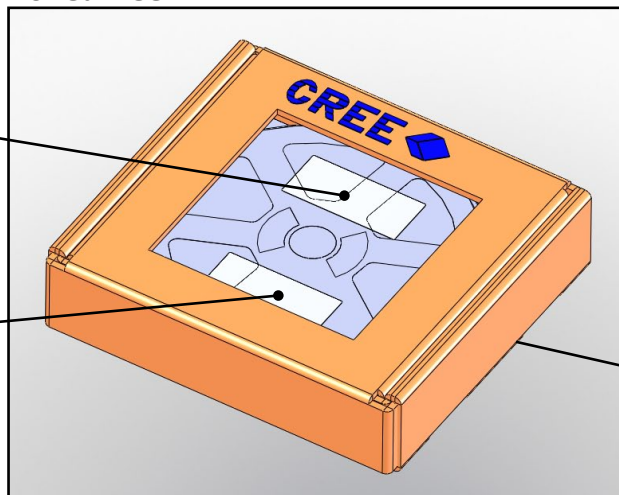

Label with Cree Order Code,  
Quantity, Reel ID, PO #

Label with Cree Bin Code,  
Quantity, Reel ID

Patent Label  
(on bottom of box)