

# Cree® PLCC6 3-in-1 SMD LED

## CLV6A-FKB



### PRODUCT DESCRIPTION

These SMD LEDs are packaged in an industry standard PLCC6 package.

These high performance tricolor SMT LEDs are designed to work in a wide range of applications. A wide viewing angle and high brightness make these LEDs suitable for outdoor signage applications.

The encapsulation resin contains UV inhibitors to minimize the effects of long-term exposure to direct sunlight, resulting in stable light output over the life of the LED.

### FEATURES

- Size (mm): 5.5 x 5.5
- Dominant Wavelength:  
Red (619 - 624nm)  
Green (520 - 540nm)  
Blue (460 - 480nm)
- Luminous Intensity (mcd)  
Red (560 - 1120)  
Green (1120 - 2240)  
Blue (280 - 560)
- Water-Resistant (IPX8\*)
- Moisture Sensitivity Level: 5a
- Lead-Free
- RoHS Compliant

### APPLICATIONS

- Outdoor Full-Color Video Screen
- Decorative lighting
- Amusement

\* This part is tested under the condition of assembling it on a PCB with isolating the electrical path by silicone.

### ABSOLUTE MAXIMUM RATINGS ( $T_A = 25^\circ\text{C}$ )

Items	Symbol	Absolute Maximum Rating			Unit
		R	G	B	
Forward Current <sup>Note 1</sup>	$I_F$	50	35	35	mA
Peak Forward Current <sup>Note 2</sup>	$I_{FP}$	200	100	100	mA
Reverse Voltage	$V_R$	5	5	5	V
Power Dissipation	$P_D$	130	140	140	mW
Operation Temperature	$T_{opr}$	-40 ~ +100			$^\circ\text{C}$
Storage Temperature	$T_{stg}$	-40 ~ +100			$^\circ\text{C}$
Junction Temperature	$T_J$	110	110	110	$^\circ\text{C}$
Junction/ambient 1 chip on	$R_{THJA}$	450	400	450	$^\circ\text{C}/\text{W}$
Junction/ambient 3 chips on	$R_{THJA}$	650	580	680	$^\circ\text{C}/\text{W}$
Junction/solder point 1 chip on	$R_{THJS}$	230	230	200	$^\circ\text{C}/\text{W}$
Junction/solder point 3 chips on	$R_{THJS}$	230	230	200	$^\circ\text{C}/\text{W}$
Electrostatic Discharge Classification(MIL-STD-883E)	ESD	1000 V			

**Note:** 1.Single-color light.  
2.Pulse width  $\leq 0.1$  msec, duty  $\leq 1/10$ .

### TYPICAL ELECTRICAL & OPTICAL CHARACTERISTICS ( $T_A = 25^\circ\text{C}$ )

Characteristics	Condition	Symbol	Values			Unit
			R	G	B	
Dominant Wavelength	$I_F = 20$ mA	$\lambda_{DOM}$	619~624	520~540	460~480	nm
Spectral bandwidth at 50% $I_{REL}$ max	$I_F = 20$ mA	$\Delta \lambda$	24	38	28	nm
Forward Voltage	$I_F = 20$ mA	$V_{F(avg)}$	2.0	3.2	3.2	V
		$V_{F(max)}$	2.6	4.0	4.0	V
Luminous Intensity	$I_F = 20$ mA	$I_{V(min)}$	560	1120	280	mcd
		$I_{V(avg)}$	700	1600	400	mcd
Reverse Current (max)	$V_R = 5$ V	$I_R$	10	10	10	$\mu\text{A}$

### INTENSITY BIN LIMIT ( $I_f = 20 \text{ mA}$ )

Red			Green			Blue		
Bin Code	Min.(mcd)	Max.(mcd)	Bin Code	Min.(mcd)	Max.(mcd)	Bin Code	Min.(mcd)	Max.(mcd)
K	560	710	P	1120	1400	G	280	355
np	635	805	vw	1260	1600	fg	318	403
M	710	900	Q	1400	1800	H	355	450
qr	805	1010	xy	1600	2020	hj	403	505
N	900	1120	R	1800	2240	J	450	560

Tolerance of measurement of luminous intensity is  $\pm 10\%$ .

### COLOR BIN LIMIT ( $I_f = 20 \text{ mA}$ )

Red			Green			Blue		
Bin Code	Min.(nm)	Max.(nm)	Bin Code	Min.(nm)	Max.(nm)	Bin Code	Min.(nm)	Max.(nm)
RB	619	624	G7	520	525	B3	460	465
			G23	522.5	527.5	B23	462.5	467.5
			G8	525	530	B4	465	470
			G45	527.5	532.5	B45	467.5	472.5
			G9	530	535	B5	470	475
			G67	532.5	537.5	B67	472.5	477.5
			Ga	535	540	B6	475	480

Tolerance of measurement of dominant wavelength is  $\pm 1 \text{ nm}$ .

**ORDER CODE TABLE\***

Kit Number	Color	Luminous Intensity (mcd)		Dominant Wavelength (nm)				Package
		Min.	Max.	Color Bin	Min. (nm)	Color Bin	Max. (nm)	
CLV6A-FKB-CKNPRGJBB7a363	Red	560	1120	RB	619	RB	624	Reel
	Green	1120	2240	G7	520	Ga	540	Reel
	Blue	280	560	B3	460	B6	480	Reel
CLV6A-FKB-CK1P1G1BB7R3R3	Red	Any 1 Intensity bin from K(560) - N(1120)		RB	619	RB	624	Reel
	Green	Any 1 Intensity bin from P(1120) - R(2240)		Any 1 hue bin from G7(520) - Ga(540)				Reel
	Blue	Any 1 Intensity bin from G(280) - J(560)		Any 1 hue bin from B3(460) - B6(480)				Reel
CLV6A-FKB-CM1Q1H1BB7R3R3	Red	Any 1 Intensity bin from M(710) - N(1120)		RB	619	RB	624	Reel
	Green	Any 1 Intensity bin from Q(1400) - R(2240)		Any 1 hue bin from G7(520) - Ga(540)				Reel
	Blue	Any 1 Intensity bin from H(355) - J(560)		Any 1 hue bin from B3(460) - B6(480)				Reel

Notes:

1. The above kit numbers represent the order codes which include multiple intensity-bin and color-bin codes. Only one intensity-bin code and one color-bin code will be shipped on each reel. Single intensity-bin code and single color-bin code will be orderable in certain quantities.
2. For example, any 1 intensity-bin from K - N means only 1 intensity-bin (K or M or N) will be shipped by Cree.
3. For example, any 1 color-bin from G7 - Ga means only 1 color-bin (G7 or G8 or G9 or Ga) will be shipped by Cree.
4. Please refer to the "Cree LED Lamp Reliability Test Standards" document for reliability test conditions.
5. Please refer to the "Cree LED Lamp Soldering & Handling" document for information about how to use this LED product safely.

GRAPHS

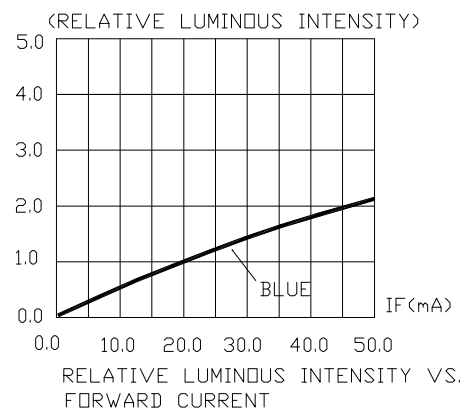
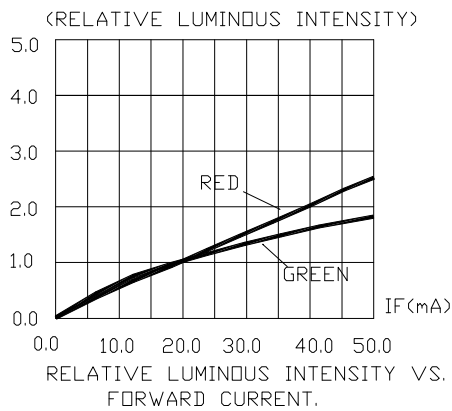
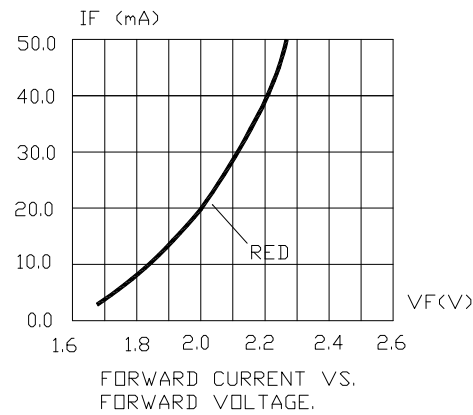
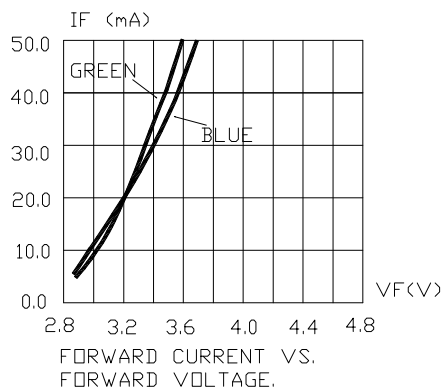
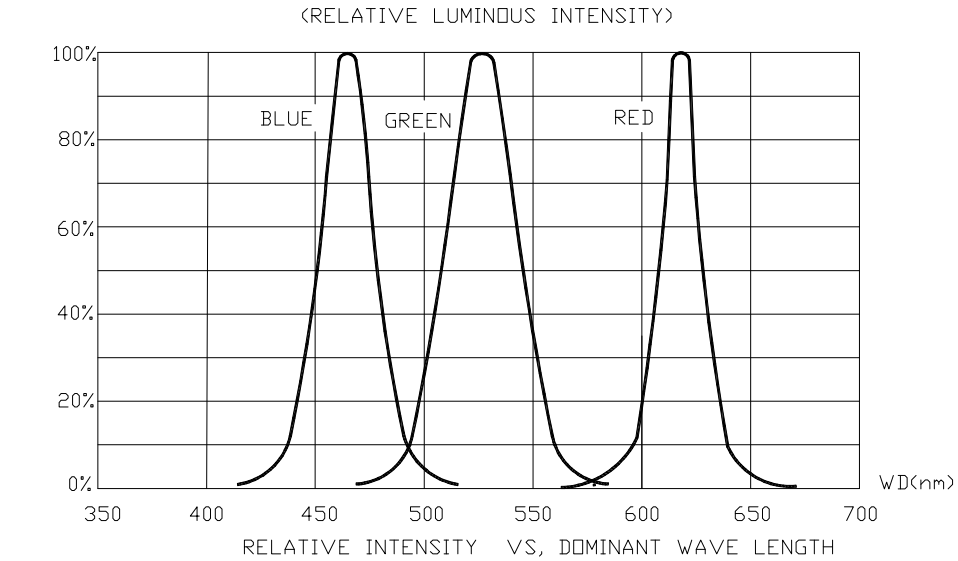

The above data are collected from statistical figures that do not necessarily correspond to the actual parameters of each single LED. Hence, these data will be changed without further notice.

GRAPHS

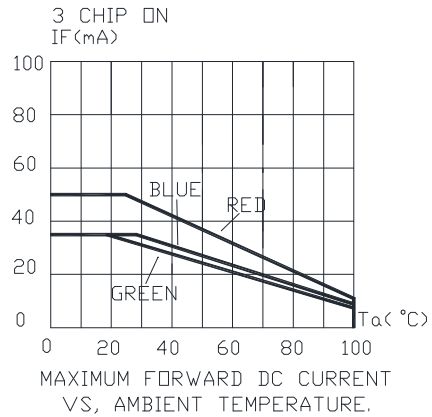
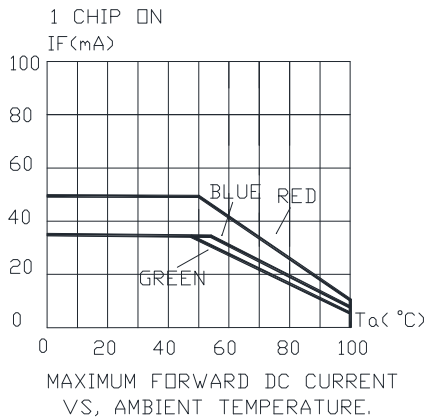
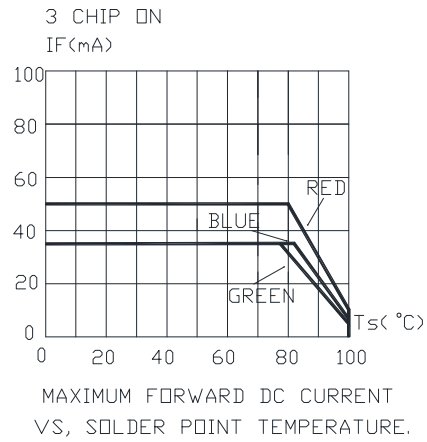
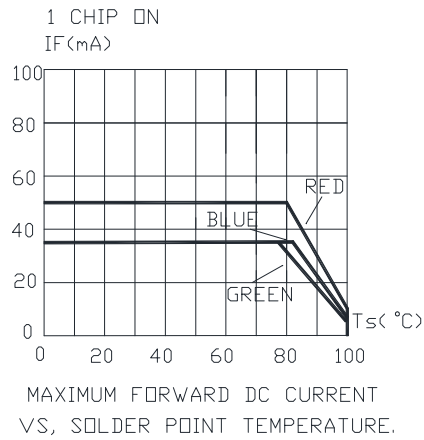
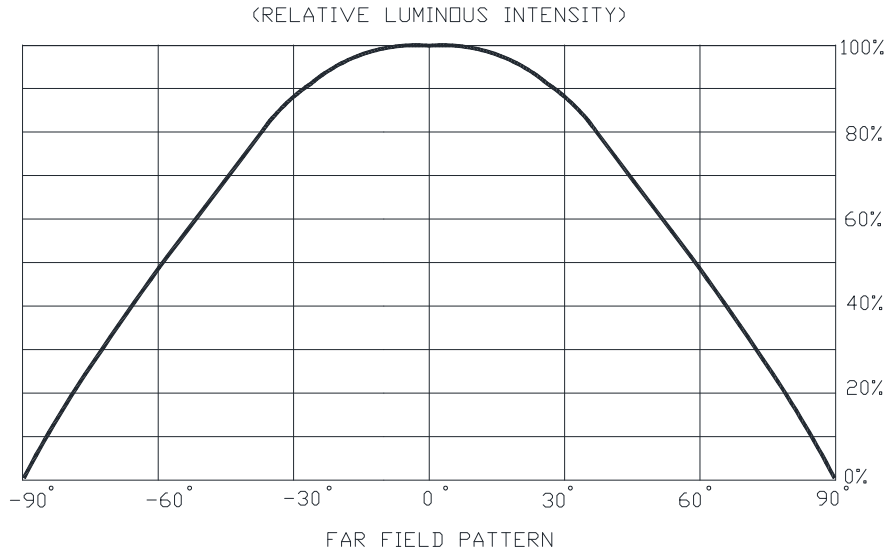

The above data are collected from statistical figures that do not necessarily correspond to the actual parameters of each single LED. Hence, these data will be changed without further notice.

## MECHANICAL DIMENSIONS

All dimensions are in mm.

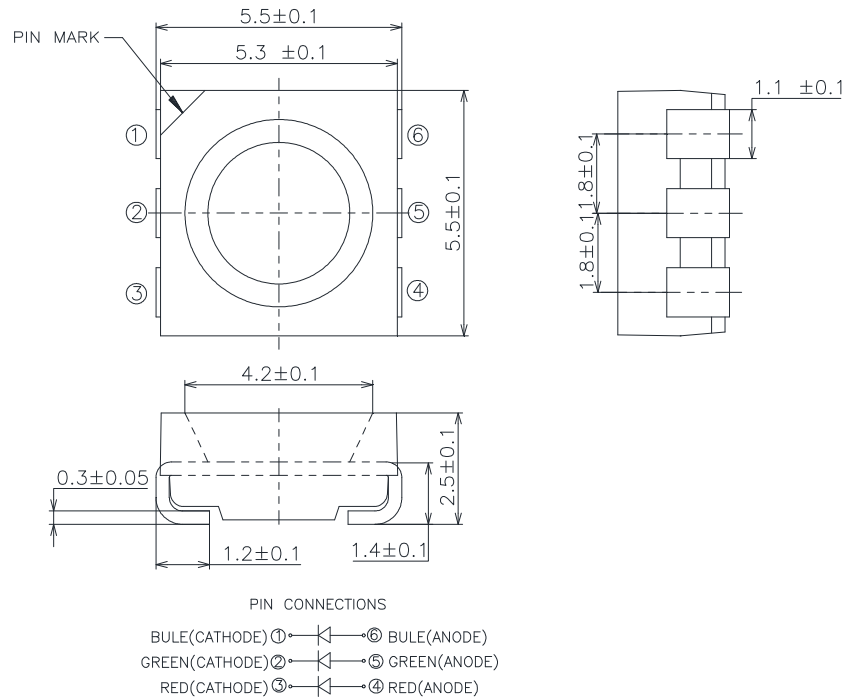

## NOTES

### RoHS Compliance

The levels of environmentally sensitive, persistent biologically toxic (PBT), persistent organic pollutants (POP), or otherwise restricted materials in this product are below the maximum concentration values (also referred to as the threshold limits) permitted for such substances, or are used in an exempted application, in accordance with EU Directive 2002/95/EC on the restriction of the use of certain hazardous substances in electrical and electronic equipment (RoHS), as amended through April 21, 2006.

### Vision Advisory Claim

Users should be cautioned not to stare at the light of this LED product. The bright light can damage the eye.

## KIT NUMBER SYSTEM

Cree LED lamps are tested and sorted into performance bins. A bin is specified by ranges of color, forward voltage, and brightness. Sorted LEDs are packaged for shipping in various convenient options. Please refer to the "Cree LED Lamp Packaging Standard" document for more information about shipping and packaging options.

Cree LEDs are sold by order codes in combinations of bins called kits. Order codes are configured in the following manner:

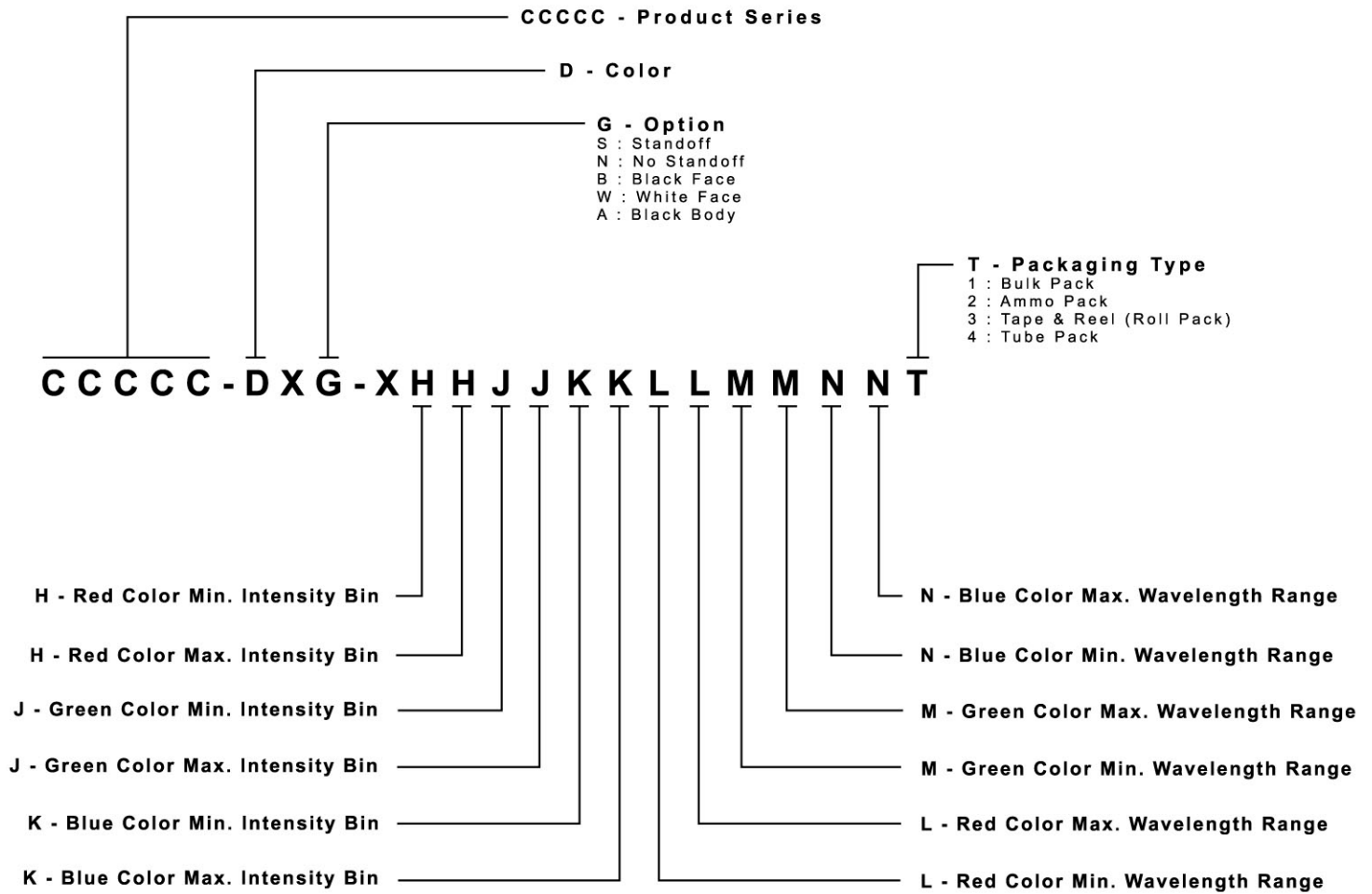



## RELIABILITY

### Tests and Results

Test	Applicable Standards	Test Condition	Note	Number of Damaged
Temperature Cycle	JEITA ED-4701 100 105	-40°C~25°C~100°C~25°C 30 mins, 5 mins, 30 mins, 5 mins	100 cycles	0/45
Thermal Shock	MIL-STD-202G	-40°C~100°C 30 mins, 30 mins	100 cycles	0/45
Moisture Resistance	JEITA ED-4701 200 203	25°C~65°C~ 90%RH 24hrs/1cycle	10 cycles	0/45
High Temperature Storage	JEITA ED-4701 200 201	T <sub>A</sub> =100°C	500 hrs	0/45
Temperature Humidity Storage	JEITA ED-4701 100 103	T <sub>A</sub> =60°C RH=90%	500 hrs	0/45
Low Temperature Storage	JEITA ED-4701 200 202	T <sub>A</sub> =-40°C	500 hrs	0/45
Water Proof Test*	IEC 60529:2001	IP X8 Immersing in 1m water	24hrs	0/45
High Temperature Life Test	-	T <sub>A</sub> =85°C I <sub>F</sub> =15 mA	1000 hrs	0/45
Life Test	-	T <sub>A</sub> =25°C IF: R=30mA G=35mA B=20mA	1000 hrs	0/45
High Humidity Heat Life Test	-	60°C RH=90% I <sub>F</sub> =15 mA	500 hrs	0/45
Low Temperature Life Test	-	T <sub>a</sub> =-40°C IF: R=30mA G=35mA B=20mA	500 hrs	0/45
Resistance to Soldering Heat(Reflow Soldering)	JEITA ED-4701 300 301	T <sub>sol</sub> =235°C,10sec (Pre treatment 30°C,70%,168hrs)	2 times	0/45
Vibration-variable Frequency	MIL-STE-883 Method 2007	20G min, 20 to 2000Hz, 4cycles, 4mins, Each x,y,z	/	0/45
Electrostatic Discharge Test	AEC(Q101-001)	Human body model 1000 V (Forward and reverse current conduct electricity each 1time)	/	0/45

Water proof test\*: The test is conducted on component level. It is strongly recommended the customers test the products for their application

### Failure Criteria

Item	Symbol	Test Condition	Criteria for Judgment	
			Min.	Max.
Forward Voltage	V <sub>F</sub>	I <sub>F</sub> = 20 mA	-	Initial Data x 1.1
Reverse Current	I <sub>R</sub>	V <sub>R</sub> = 5 V	-	100 μA
Luminous Flux/Intensity	Φ <sub>V</sub>	I <sub>F</sub> = 20 mA	Initial Data x 0.7	-
Resistance to Soldering Heat	-	I <sub>F</sub> = 20 mA	No dead lamps and visual damage	
Vibration-variable Frequency	-	I <sub>F</sub> = 20 mA	No dead lamps and visual damage	

## REFLOW SOLDERING

- The CLV6A-FKB is rated as a MSL 5a product.
- The recommended floor life out of bag is 24hrs.
- The best practices suggestion is to bake 24-hour/80°C before use.
- The temperature profile is as below.

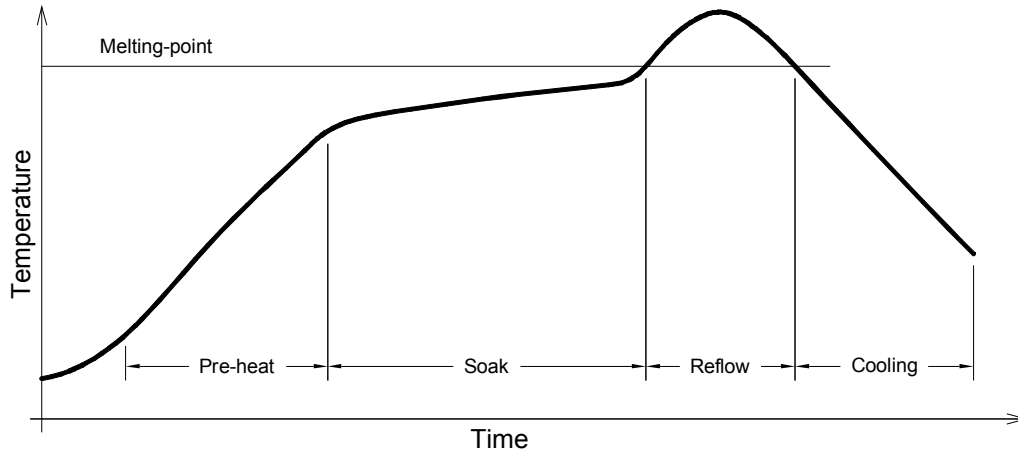

Use only with CLV6A-FKB

Solder
Average ramp-up rate = 4°C/s max
Preheat temperature = 150°C ~200°C
Preheat time = 120s max
Ramp-down rate = 6°C/s max
Peak temperature = 235°C max
Time within 5°C of actual Peak Temperature = 10s max
Duration above 217°C is 45s max

Soldering pad:

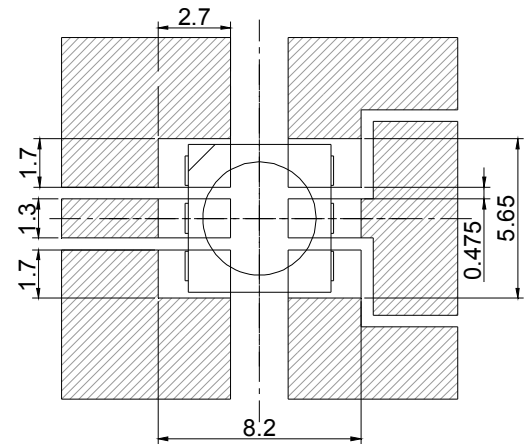

## PACKAGING

- The boxes are not water resistant and they must be kept away from water and moisture.
- The LEDs are packed in cardboard boxes after packaging in normal or anti-electrostatic bags.
- Cardboard boxes will be used to protect the LEDs from mechanical shocks during transportation.
- The reel pack is applied in SMD LED.
- Max 3000 pcs per reel.

