

## Cree® XLamp® MX-6 LEDs



### PRODUCT DESCRIPTION

The Cree XLamp® MX-6 LED provides the proven lighting-class performance and reliability of Cree XLamp LEDs in a flat-top PLCC package. The XLamp MX-6 LED continues Cree’s history of innovation in LEDs for lighting applications with wide viewing angle, unlimited floor life, uniform light output without secondary optics and electrically neutral thermal path.

The XLamp MX-6 LED brings high performance and quality of light to a wide range of lighting applications, including linear lighting, LED light bulbs, fluorescent retrofits and retail-display lighting.

### FEATURES

- Available in white (2200 K and 2600 K to 8300 K CCT)
- Maximum drive current: 1000 mA
- Wide viewing angle: 120°
- Electrically neutral thermal path
- Qualification at max drive current
- RoHS and REACH compliant
- UL® recognized component (E349212)

### TABLE OF CONTENTS

Characteristics .....	2
Flux Characteristics .....	3
Relative Spectral Power Distribution .....	4
Relative Flux vs. Junction Temperature..	4
Electrical Characteristics.....	5
Relative Flux vs. Current .....	5
Typical Spatial Distribution.....	6
Thermal Design .....	6
Reflow Soldering Characteristics.....	7
Notes .....	8
Mechanical Dimensions .....	10
Tape and Reel.....	11
Packaging.....	12



**CHARACTERISTICS**

Characteristics	Unit	Minimum	Typical	Maximum
Thermal resistance, junction to solder point	°C/W		5	
Viewing angle (FWHM)	degrees		120	
Temperature coefficient of voltage	mV/°C		-3.3	
ESD classification (HBM per Mil-Std-883D)			Class 2	
DC forward current	mA			1000
Forward voltage (@ 300 mA)	V		3.3	3.8
LED junction temperature	°C			150

**FLUX CHARACTERISTICS (T<sub>j</sub> = 25 °C)**

The following table provides several base order codes for XLamp MX-6 LEDs. It is important to note that the base order codes listed here are a subset of the total available order codes for the product family. For more order codes, as well as a complete description of the order-code nomenclature, please consult the XLamp MX LED Family Binning & Labeling document.

Color	CCT Range		Minimum Luminous Flux (lm) @ 300 mA		Calculated Minimum Luminous Flux (lm) @ 350 mA*	Order Code
	Minimum	Maximum	Group	Flux (lm)	Flux (lm)	
Cool White	5000 K	8300 K	Rs	114	130	MX6AWT-A1-0000-000E51
			Q5	107	122	MX6AWT-A1-0000-000D51
			Q5	107	122	MX6AWT-A1-0000-000DE3
			Q4	100	114	MX6AWT-A1-0000-000CE3
80-CRI White	5000 K	8300 K	Q5	107	122	MX6AWT-H1-0000-000D51
			Q4	100	114	MX6AWT-H1-0000-000C51
			Q5	107	122	MX6AWT-H1-0000-000DE3
			Q4	107	114	MX6AWT-H1-0000-000CE3
	3700 K	4300 K	Q4	100	114	MX6AWT-H1-0000-000CE5
			Q3	93.9	107	MX6AWT-H1-0000-000BE5
	2600 K	3700 K	Q3	93.9	107	MX6AWT-H1-0000-000BE7
			Q2	87.4	100	MX6AWT-H1-0000-000AE7
Warm White	3700 K	4300 K	Q4	100	114	MX6AWT-A1-0000-000CE5
			Q3	93.9	107	MX6AWT-A1-0000-000BE5
	2600 K	3700 K	Q3	93.9	107	MX6AWT-A1-0000-000BE7
			Q2	87.4	100	MX6AWT-A1-0000-000AE7
	2200 K	2200 K	P4	80.6	92	MX6AWT-A1-0000-0009EA
			P3	73.9	84	MX6AWT-A1-0000-0008EA
P2			67.2	77	MX6AWT-A1-0000-0007EA	

**Notes:**

- Cree maintains a tolerance of ±7% on flux and power measurements, ±0.005 on chromaticity (CCx, CCy) measurements and ±2 on CRI measurements. See the Measurements section (page 8).
- Typical CRI for Cool White (4300 K – 8300 K CCT) is 75.
- Typical CRI for Warm White (2200 K and 2600 K – 4300 K CCT) is 80.
- Minimum CRI for 80-CRI White is 80.
- \* Calculated values for reference purposes only.

**RELATIVE SPECTRAL POWER DISTRIBUTION**



**RELATIVE FLUX VS. JUNCTION TEMPERATURE ( $I_F = 300$  mA)**



**ELECTRICAL CHARACTERISTICS ( $T_j = 25\text{ }^\circ\text{C}$ )**

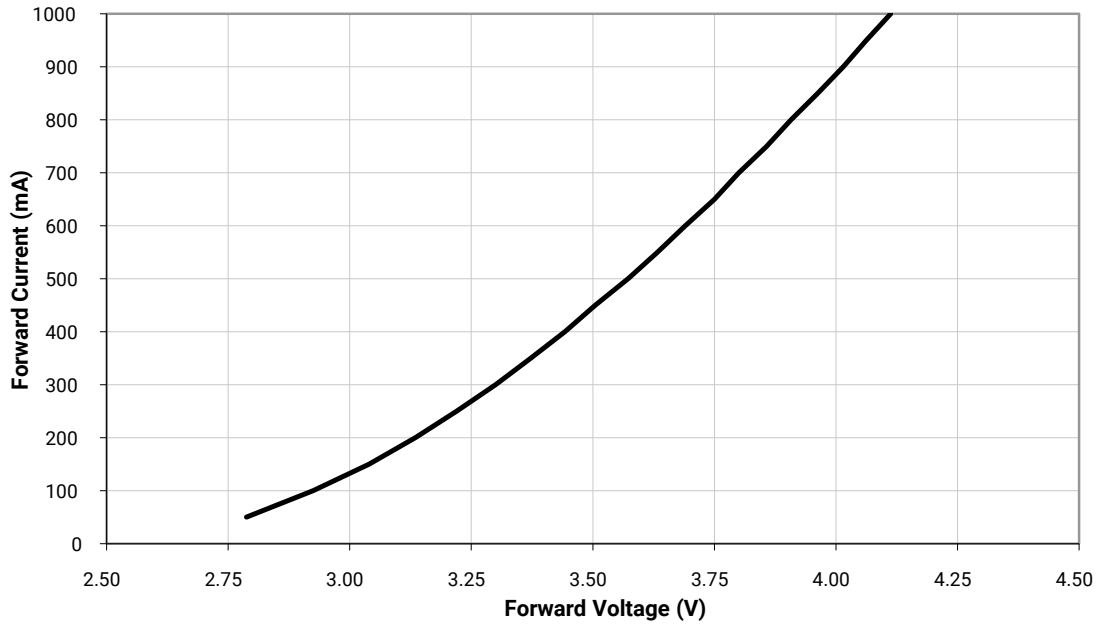

**RELATIVE FLUX VS. CURRENT ( $T_j = 25\text{ }^\circ\text{C}$ )**

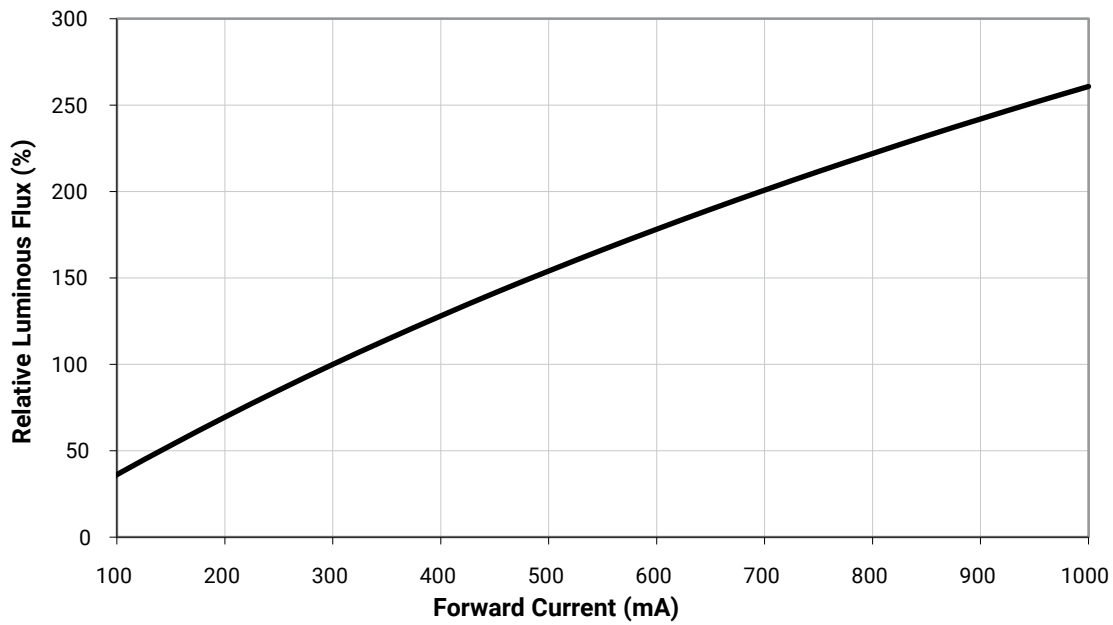

**TYPICAL SPATIAL DISTRIBUTION**



**THERMAL DESIGN**

The maximum forward current is determined by the thermal resistance between the LED junction and ambient. It is crucial for the end product to be designed in a manner that minimizes the thermal resistance from the solder point to ambient in order to optimize lamp life and optical characteristics.



**REFLOW SOLDERING CHARACTERISTICS**

In testing, Cree has found XLamp MX-6 LEDs to be compatible with JEDEC J-STD-020C, using the parameters listed below. As a general guideline, Cree recommends that users follow the recommended soldering profile provided by the manufacturer of the solder paste used.

Note that this general guideline may not apply to all PCB designs and configurations of reflow soldering equipment.



IPC/JEDEC J-STD-020C

Profile Feature	Lead-Free Solder
Average Ramp-Up Rate ( $T_{s_{max}}$ to $T_P$ )	1.2 °C/second
Preheat: Temperature Min ( $T_{s_{min}}$ )	120 °C
Preheat: Temperature Max ( $T_{s_{max}}$ )	170 °C
Preheat: Time ( $t_{s_{min}}$ to $t_{s_{max}}$ )	65-150 seconds
Time Maintained Above: Temperature ( $T_L$ )	217 °C
Time Maintained Above: Time ( $t_L$ )	45-90 seconds
Peak/Classification Temperature ( $T_P$ )	235 - 245 °C
Time Within 5 °C of Actual Peak Temperature ( $t_p$ )	20-40 seconds
Ramp-Down Rate	1 - 6 °C/second
Time 25 °C to Peak Temperature	4 minutes max.

Note: All temperatures refer to the topside of the package, measured on the package body surface.

**NOTES**

**Measurements**

The luminous flux, radiant power, chromaticity, forward voltage and CRI measurements in this document are binning specifications only and solely represent product measurements as of the date of shipment. These measurements will change over time based on a number of factors that are not within Cree’s control and are not intended or provided as operational specifications for the products. Calculated values are provided for informational purposes only and are not intended as specifications.

**Pre-Release Qualification Testing**

Please read the [LED Reliability Overview](#) for details of the qualification process Cree applies to ensure long-term reliability for XLamp LEDs and details of Cree’s pre-release qualification testing for XLamp LEDs.

**Lumen Maintenance**

Cree now uses standardized IES LM-80-08 and TM-21-11 methods for collecting long-term data and extrapolating LED lumen maintenance. For information on the specific LM-80 data sets available for this LED, refer to the public [LM-80 results document](#).

Please read the [Long-Term Lumen Maintenance application note](#) for more details on Cree’s lumen maintenance testing and forecasting. Please read the [Thermal Management application note](#) for details on how thermal design, ambient temperature and drive current affect the LED junction temperature.

**Moisture Sensitivity**

Cree recommends keeping XLamp MX-6 LEDs in the provided, resealable moisture-barrier packaging (MBP) until immediately prior to soldering. Unopened MBPs that contain XLamp LEDs do not need special storage for moisture sensitivity.

Once the MBP is opened, XLamp MX-6 LEDs should be handled and stored as MSL 2a per JEDEC J-STD-033, meaning they have limited exposure time before damage to the LED may occur during the soldering operation. The table on the right specifies the maximum exposure time in days depending on temperature and humidity conditions. LEDs with exposure time longer than the specified maximums must be baked according to the baking conditions listed below.

Temp.	Maximum Percent Relative Humidity						
	30%	40%	50%	60%	70%	80%	90%
35 °C	-	-	-	17	1	.5	.5
30 °C	-	-	-	28	1	1	1
25 °C	-	-	-	-	2	1	1
20 °C	-	-	-	-	2	1	1

**Baking Conditions**

It is not necessary to bake all XLamp MX-6 LEDs. Only the LEDs that meet all of the following criteria must be baked:

1. LEDs that have been removed from the original MBP.
2. LEDs that have been exposed to a humid environment longer than listed in the Moisture Sensitivity section above.
3. LEDs that have not been soldered.

LEDs should be baked at 70 °C for 24 hours. LEDs may be baked on the original reels. Remove LEDs from the MBP before baking. Do not bake parts at temperatures higher than 70 °C. This baking operation resets the exposure time as defined in the Moisture Sensitivity section above.



## NOTES - CONTINUED

---

### Storage Conditions

XLamp MX-6 LEDs that have been removed from the original MBP but not soldered should be stored in one of the following ways:

- Store the parts in a rigid metal container with a tight-fitting lid. Verify that the storage temperature is <30 °C, and place fresh desiccant and an RH indicator in the container to verify that the RH is no greater than 60%.
- Store the parts in a dry, nitrogen-purged cabinet or container that actively maintains the temperature at <30° and the RH at no greater than 60%.
- For short-term store only: LEDs can be resealed in the original MBP soon after opening. Fresh desiccant may be needed. Use the included humidity indicator card to verify <60% RH.

If an environment of <60% RH is not available for storage, XLamp MX-6 LEDs should be baked (described above) before reflow soldering.

### RoHS Compliance

The levels of RoHS restricted materials in this product are below the maximum concentration values (also referred to as the threshold limits) permitted for such substances, or are used in an exempted application, in accordance with EU Directive 2011/65/EC (RoHS2), as implemented January 2, 2013. RoHS Declarations for this product can be obtained from your Cree representative or from the [Product Ecology](#) section of the Cree website.

### REACH Compliance

REACH substances of very high concern (SVHCs) information is available for this product. Since the European Chemical Agency (ECHA) has published notice of their intent to frequently revise the SVHC listing for the foreseeable future, please contact a Cree representative to insure you get the most up-to-date REACH SVHC Declaration. REACH banned substance information (REACH Article 67) is also available upon request.

### UL® Recognized Component

Level 4 enclosure consideration. The LED package or a portion thereof has been investigated as a fire and electrical enclosure per ANSI/UL 8750.

### Vision Advisory

**WARNING:** Do not look at an exposed lamp in operation. Eye injury can result. For more information about LEDs and eye safety, please refer to the [LED Eye Safety application note](#).

**MECHANICAL DIMENSIONS**

All measurements are  $\pm .13$  mm unless otherwise indicated.

**Top View**



**Top View**



**Bottom View**



**Side View**

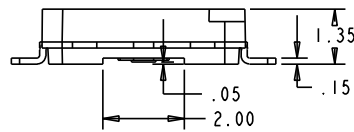

**Recommended FR4 Solder Pad**



**Recommended MCPCB Solder Pad**



**Alternative Solder Pad**

**TAPE AND REEL**

All Cree carrier tapes conform to EIA-481D, Automated Component Handling Systems Standard.

Except as noted, all dimensions in mm.

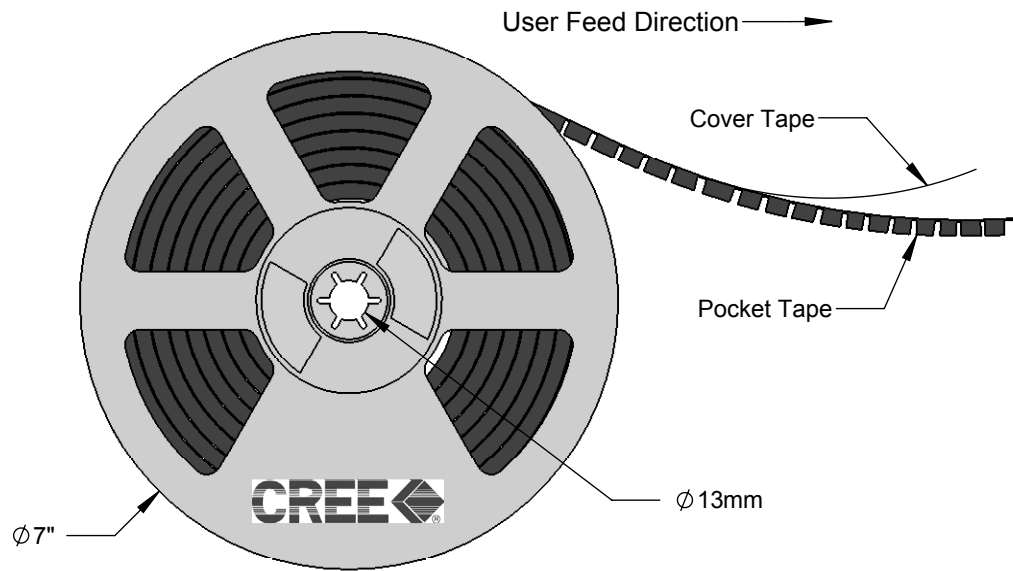

**PACKAGING**

**Unpackaged Reel**

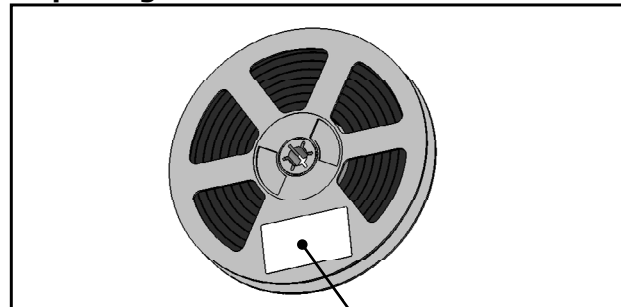

Label with Cree Bin Code, Quantity, Reel ID

**Packaged Reel**

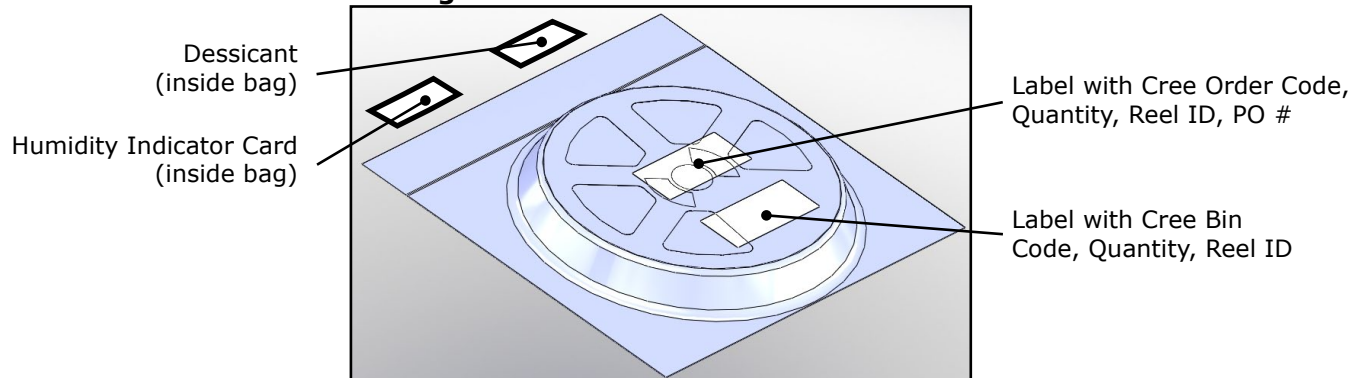

Dessicant (inside bag)

Humidity Indicator Card (inside bag)

Label with Cree Order Code, Quantity, Reel ID, PO #

Label with Cree Bin Code, Quantity, Reel ID

**Boxed Reel**

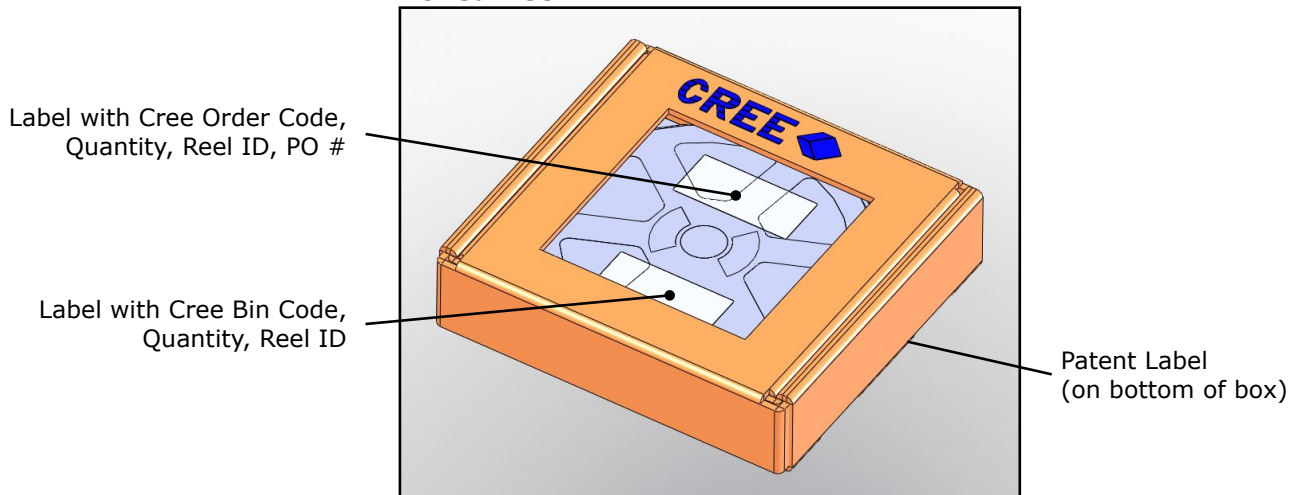

Label with Cree Order Code, Quantity, Reel ID, PO #

Label with Cree Bin Code, Quantity, Reel ID

Patent Label (on bottom of box)