

# Cree® XLamp® XM-L LEDs

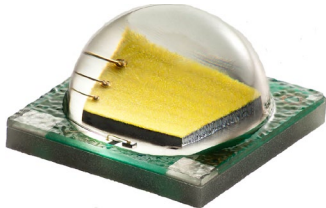

## PRODUCT DESCRIPTION

The XLamp® XM-L LED is the industry's highest performance, single-die white lighting-class LED. The XLamp XM-L LED is 20% more efficient than the XLamp XP-G LED at the same current, and can deliver 1000 lumens with 100 lumens per watt efficacy. The XLamp XM-L LED offers Cree's industry-leading features: wide viewing angle, symmetrical package, unlimited floor life and electrically neutral thermal path.

XLamp XM-L LEDs can enable LED light into new applications that require tens of thousands of lumens, such as high bay and high-output area lighting. The XM-L is also the ideal choice for lighting applications where high light output and maximum efficacy are required, such as LED light bulbs, outdoor lighting, portable lighting, indoor lighting and solar-powered lighting.

## FEATURES

- Maximum drive current: 3000 mA
- Low thermal resistance: 2.5 °C/W
- Maximum junction temperature: 150 °C
- Viewing angle: 125°
- Available in cool white, 80-CRI minimum neutral white and 80-CRI, 85-CRI and 90-CRI warm white
- ANSI-compatible chromaticity bins
- Unlimited floor life at ≤ 30 °C/85% RH
- Reflow solderable - JEDEC J-STD-020C
- Electrically neutral thermal path
- RoHS and REACH compliant
- UL® recognized component (E349212)



## TABLE OF CONTENTS

|  |    |
|--|----|
| Characteristics .....                                    | 2  |
| Flux Characteristics .....                               | 3  |
| Relative Spectral Power Distribution ....                | 4  |
| Relative Flux vs. Junction Temperature .....             | 4  |
| Electrical Characteristics .....                         | 5  |
| Relative Flux vs. Current .....                          | 5  |
| Relative Chromaticity vs. Current (Cool White).....      | 6  |
| Relative Chromaticity vs. Temperature (Cool White).....  | 6  |
| Relative Chromaticity vs. Current (Warm White) .....     | 7  |
| Relative Chromaticity vs. Temperature (Warm White) ..... | 7  |
| Typical Spatial Distribution.....                        | 8  |
| Thermal Design.....                                      | 8  |
| Reflow Soldering Characteristics.....                    | 9  |
| Notes .....  | 10 |
| Mechanical Dimensions .....                              | 12 |
| Tape and Reel.....                                       | 13 |
| Packaging.....   | 14 |

**CHARACTERISTICS**

| Characteristics                              | Unit    | Minimum | Typical | Maximum |
|--|---------|---------|---------|---------|
| Thermal resistance, junction to solder point | °C/W    |         | 2.5     |         |
| Viewing angle (FWHM)                         | degrees |         | 125     |         |
| Temperature coefficient of voltage           | mV/°C   |         | -2.1    |         |
| ESD withstand voltage (HBM per Mil-Std-883D) | V       |         |         | 8000    |
| DC forward current                           | mA      |         |         | 3000    |
| Reverse voltage                              | V       |         |         | 5       |
| Forward voltage (@ 700 mA)                   | V       |         | 2.9     | 3.5     |
| Forward voltage (@ 1500 mA)                  | V       |         | 3.1     |         |
| Forward voltage (@ 3000 mA)                  | V       |         | 3.35    |         |
| LED junction temperature                     | °C      |         |         | 150     |

## FLUX CHARACTERISTICS (T<sub>j</sub> = 25 °C)

The following table provides several base order codes for XLamp XM-L LEDs. It is important to note that the base order codes listed here are a subset of the total available order codes for the product family. For more order codes, as well as a complete description of the order-code nomenclature, please consult the XLamp XM-L LED Binning and Labeling document.

| Color         | CCT Range |        | Minimum Luminous Flux @ 700 mA |           | Calculated Minimum Luminous Flux (lm)* |         |         | Order Code               |
|---------------|-----------|--------|--------------------------------|-----------|--|---------|---------|--------------------------|
|               | Min.      | Max.   | Group                          | Flux (lm) | 1000 mA                                | 1500 mA | 2000 mA |                          |
| Cool White    | 5000 K    | 8300 K | T5                             | 260       | 360                                    | 511     | 643     | XMLAWT-00-0000-0000T5051 |
|               |           |        | T6                             | 280       | 388                                    | 551     | 692     | XMLAWT-00-0000-0000T6051 |
|               |           |        | U2                             | 300       | 416                                    | 590     | 742     | XMLAWT-00-0000-0000U2051 |
| Neutral White | 3700 K    | 5000 K | T4                             | 240       | 332                                    | 472     | 593     | XMLAWT-00-0000-000LT40E4 |
|               |           |        | T5                             | 260       | 360                                    | 511     | 643     | XMLAWT-00-0000-000LT50E4 |
| 80-CRI White  | 2600 K    | 4300 K | T2                             | 200       | 277                                    | 393     | 494     | XMLAWT-00-0000-000HT20E7 |
|               |           |        | T3                             | 220       | 305                                    | 433     | 544     | XMLAWT-00-0000-000HT30F7 |
| Warm White    | 2600 K    | 3700 K | T2                             | 200       | 277                                    | 393     | 494     | XMLAWT-00-0000-000LT20E7 |
|               |           |        | T3                             | 220       | 305                                    | 433     | 544     | XMLAWT-00-0000-000LT30F7 |
| 85-CRI White  | 2600 K    | 3200 K | S4                             | 164       | 227                                    | 323     | 406     | XMLAWT-00-0000-000PS40E7 |
|               |           |        | S5                             | 172       | 238                                    | 338     | 425     | XMLAWT-00-0000-000PS50E7 |
|               |           |        | S6                             | 182       | 252                                    | 358     | 450     | XMLAWT-00-0000-000PS60E7 |
| 90-CRI White  | 2600 K    | 3200 K | S4                             | 164       | 227                                    | 323     | 406     | XMLAWT-00-0000-000US40E7 |
|               |           |        | S5                             | 172       | 238                                    | 338     | 425     | XMLAWT-00-0000-000US50E7 |
|               |           |        | S6                             | 182       | 252                                    | 358     | 450     | XMLAWT-00-0000-000US60E7 |

### Notes:

- Cree maintains a tolerance of ±7% on flux and power measurements, ±0.005 on chromaticity (CCx, CCy) measurements and ±2 on CRI measurements. See the Measurements section (page 10).
- Typical CRI for Cool White (5000 K – 8300 K CCT) is 65.
- Typical CRI for Neutral White (3700 K – 5000 K CCT) is 75.
- Typical CRI for Warm White (2600 K – 3700 K CCT) is 80.
- Minimum CRI for 80-CRI White is 80.
- Minimum CRI for 85-CRI White is 85.
- Minimum CRI for 90-CRI White is 90
- \* Calculated flux values are for reference only.

**RELATIVE SPECTRAL POWER DISTRIBUTION**

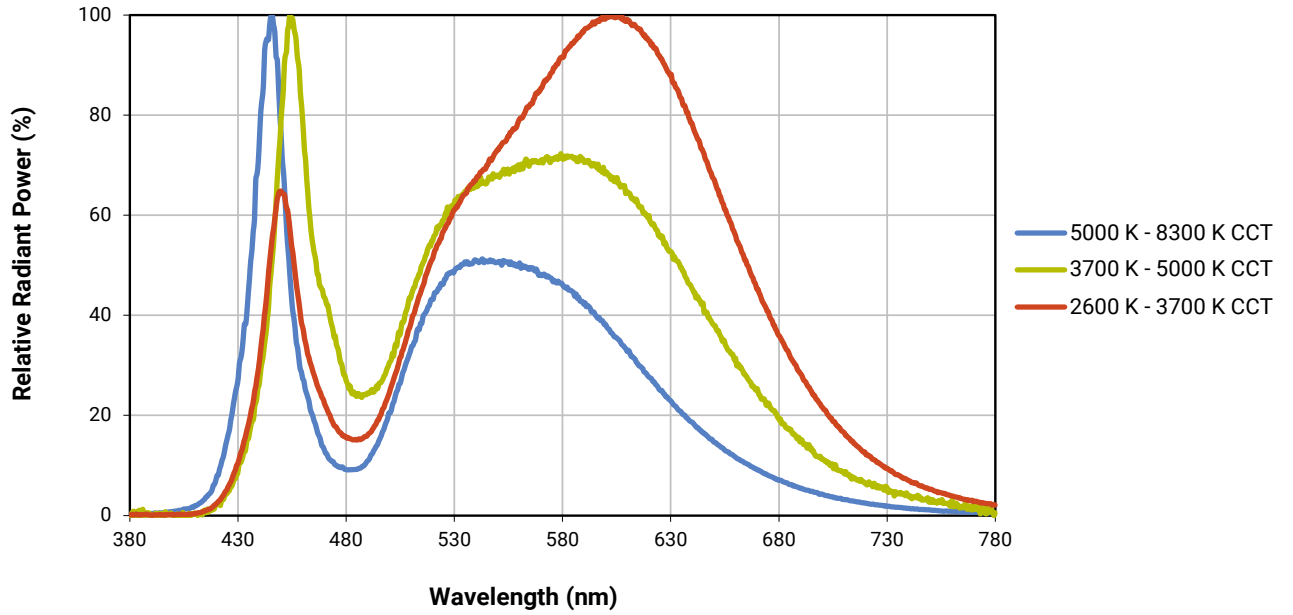

**RELATIVE FLUX VS. JUNCTION TEMPERATURE ( $I_F = 700$  mA)**



**ELECTRICAL CHARACTERISTICS ( $T_j = 25\text{ }^\circ\text{C}$ )**



**RELATIVE FLUX VS. CURRENT ( $T_j = 25\text{ }^\circ\text{C}$ )**



**RELATIVE CHROMATICITY VS. CURRENT (COOL WHITE)**



**RELATIVE CHROMATICITY VS. TEMPERATURE (COOL WHITE)**



**RELATIVE CHROMATICITY VS. CURRENT (WARM WHITE)**



**RELATIVE CHROMATICITY VS. TEMPERATURE (WARM WHITE)**

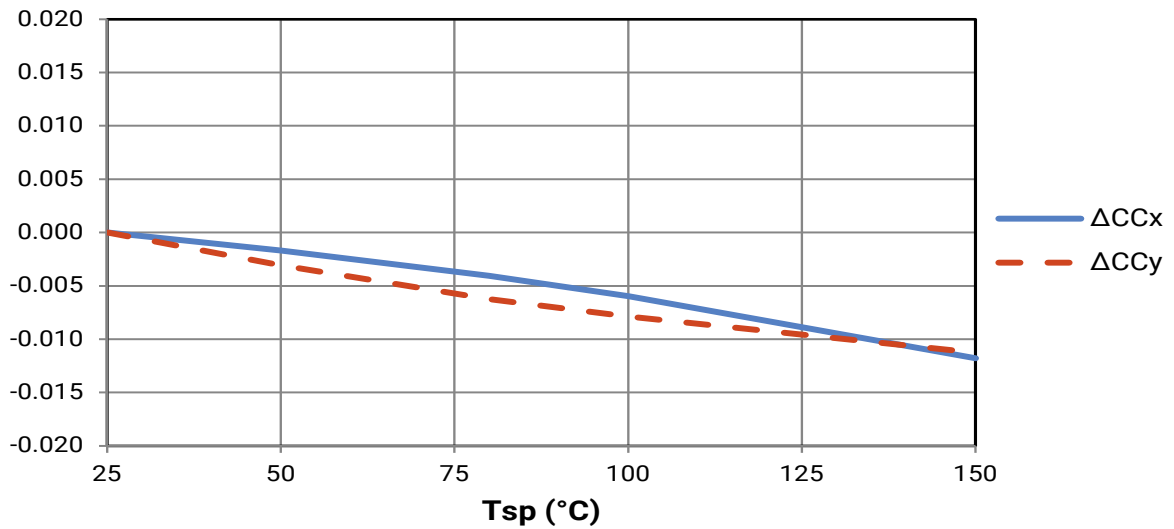

**TYPICAL SPATIAL DISTRIBUTION**



**THERMAL DESIGN**

The maximum forward current is determined by the thermal resistance between the LED junction and ambient. It is crucial for the end product to be designed in a manner that minimizes the thermal resistance from the solder point to ambient in order to optimize lamp life and optical characteristics.

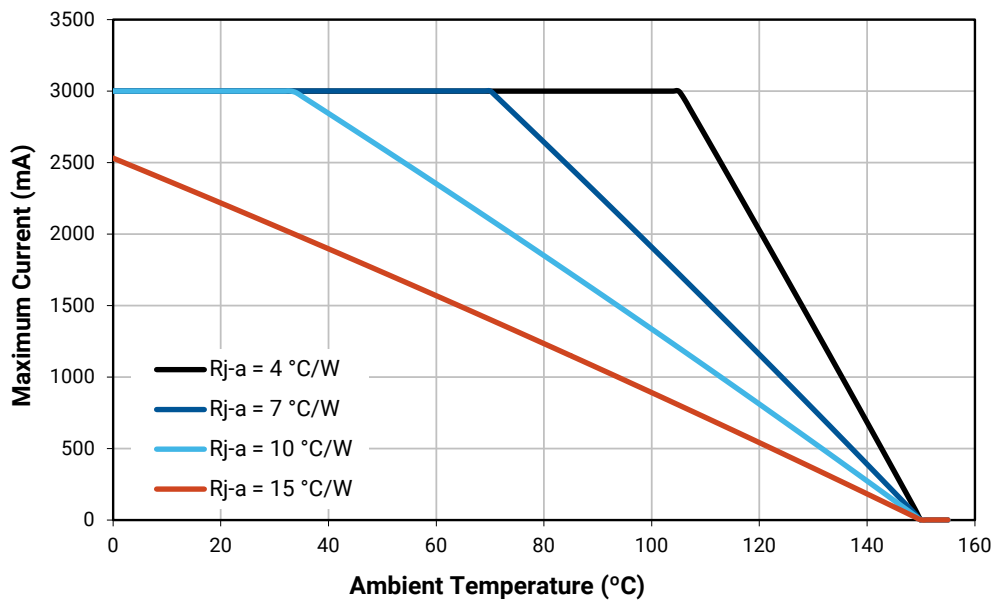



**REFLOW SOLDERING CHARACTERISTICS**

In testing, Cree has found XLamp XM-L LEDs to be compatible with JEDEC J-STD-020C, using the parameters listed below. As a general guideline, Cree recommends that users follow the recommended soldering profile provided by the manufacturer of the solder paste used.

Note that this general guideline may not apply to all PCB designs and configurations of reflow soldering equipment.

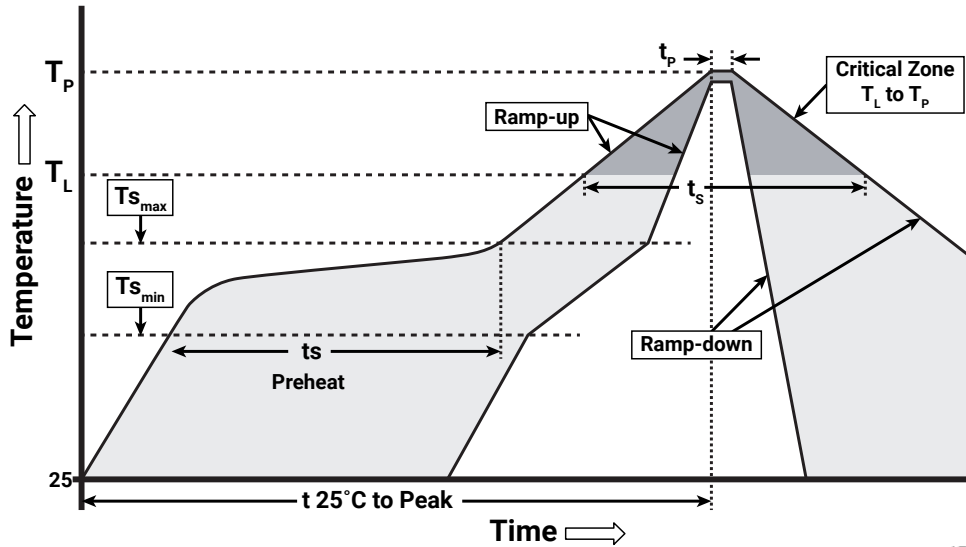

IPC/JEDEC J-STD-020C

| Profile Feature                                       | Lead-Free Solder |
|---|------------------|
| Average Ramp-Up Rate ( $T_{s_{max}}$ to $T_P$ )       | 1.2 °C/second    |
| Preheat: Temperature Min ( $T_{s_{min}}$ )            | 120 °C           |
| Preheat: Temperature Max ( $T_{s_{max}}$ )            | 170 °C           |
| Preheat: Time ( $t_{s_{min}}$ to $t_{s_{max}}$ )      | 65-150 seconds   |
| Time Maintained Above: Temperature ( $T_L$ )          | 217 °C           |
| Time Maintained Above: Time ( $t_L$ )                 | 45-90 seconds    |
| Peak/Classification Temperature ( $T_P$ )             | 235 - 245 °C     |
| Time Within 5 °C of Actual Peak Temperature ( $t_p$ ) | 20-40 seconds    |
| Ramp-Down Rate  | 1 - 6 °C/second  |
| Time 25 °C to Peak Temperature                        | 4 minutes max.   |

Note: All temperatures refer to the topside of the package, measured on the package body surface.

## NOTES

---

### Measurements

The luminous flux, radiant power, chromaticity, forward voltage and CRI measurements in this document are binning specifications only and solely represent product measurements as of the date of shipment. These measurements will change over time based on a number of factors that are not within Cree's control and are not intended or provided as operational specifications for the products. Calculated values are provided for informational purposes only and are not intended as specifications.

### Pre-Release Qualification Testing

Please read the [LED Reliability Overview](#) for details of the qualification process Cree applies to ensure long-term reliability for XLamp LEDs and details of Cree's pre-release qualification testing for XLamp LEDs.

### Lumen Maintenance

Cree now uses standardized IES LM-80-08 and TM-21-11 methods for collecting long-term data and extrapolating LED lumen maintenance. For information on the specific LM-80 data sets available for this LED, refer to the public [LM-80 results document](#).

Please read the [Long-Term Lumen Maintenance application note](#) for more details on Cree's lumen maintenance testing and forecasting. Please read the [Thermal Management application note](#) for details on how thermal design, ambient temperature, and drive current affect the LED junction temperature.

### Moisture Sensitivity

Cree recommends keeping XLamp LEDs in the provided, resealable moisture-barrier packaging (MBP) until immediately prior to soldering. Unopened MBPs that contain XLamp LEDs do not need special storage for moisture sensitivity.

Once the MBP is opened, XLamp XM-L LEDs may be stored as MSL 1 per JEDEC J-STD-033, meaning they have unlimited floor life in conditions of  $\leq 30$  °C/85% relative humidity (RH). Regardless of the storage condition, Cree recommends sealing any unsoldered LEDs in the original MBP.

### RoHS Compliance

The levels of RoHS restricted materials in this product are below the maximum concentration values (also referred to as the threshold limits) permitted for such substances, or are used in an exempted application, in accordance with EU Directive 2011/65/EC (RoHS2), as implemented January 2, 2013. RoHS Declarations for this product can be obtained from your Cree representative or from the Product Documentation sections of [www.cree.com](http://www.cree.com).

### REACH Compliance

REACH substances of very high concern (SVHCs) information is available for this product. Since the European Chemical Agency (ECHA) has published notice of their intent to frequently revise the SVHC listing for the foreseeable future, please contact a Cree representative to insure you get the most up-to-date REACH SVHC Declaration. REACH banned substance information (REACH Article 67) is also available upon request.

**NOTES - CONTINUED**

---

**UL® Recognized Component**

Level 4 enclosure consideration. The LED package or a portion thereof has been investigated as a fire and electrical enclosure per ANSI/UL 8750.

**Vision Advisory**

WARNING: Do not look at exposed lamp in operation. Eye injury can result. For more information about LEDs and eye safety, please refer to the [LED Eye Safety application note](#).

**MECHANICAL DIMENSIONS**

Thermal vias, if present, are not shown on these drawings.

All measurements are  $\pm 0.13$  mm unless otherwise indicated.

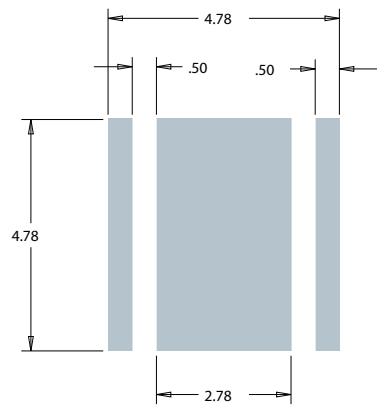

**Recommended PCB Solder Pad**

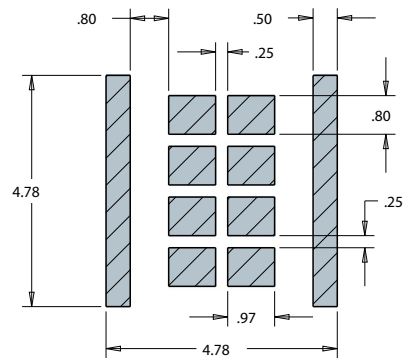

**Recommended Stencil Pattern  
(Shaded Area Is Open)**

**TAPE AND REEL**

All Cree carrier tapes conform to EIA-481D, Automated Component Handling Systems Standard.

All dimensions in mm.

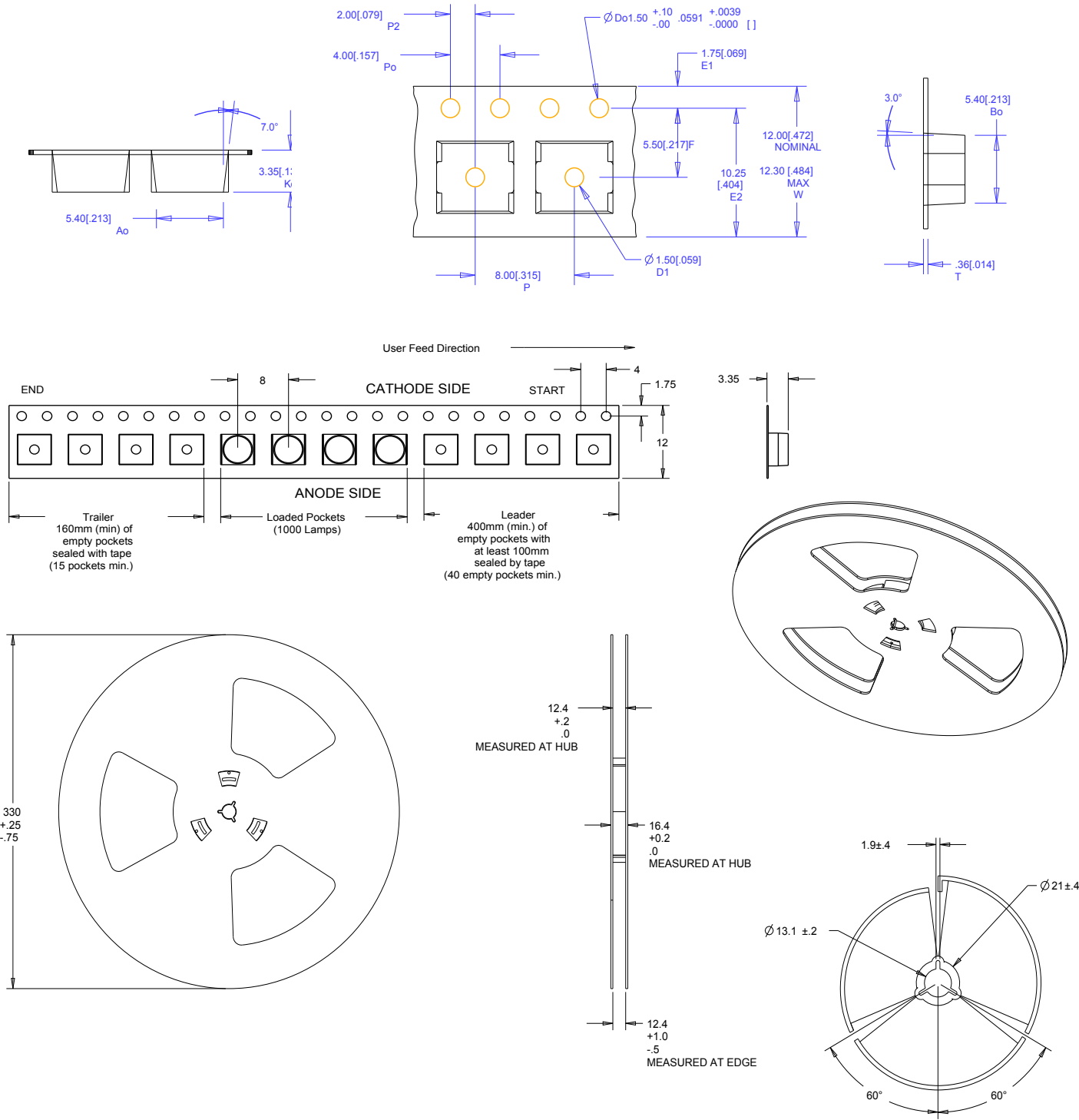

**PACKAGING**

**Unpackaged Reel**



Label with Cree Bin Code,  
Quantity, Reel ID

**Packaged Reel**



Label with Cree Order Code,  
Quantity, Reel ID, PO #

Label with Cree Bin Code,  
Quantity, Reel ID

**Boxed Reel**



Label with Cree Order Code,  
Quantity, Reel ID, PO #

Patent Label

Label with Cree Bin Code,  
Quantity, Reel ID