

Cree® XLamp® ML-C LEDs

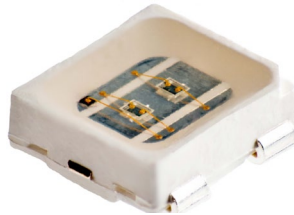

PRODUCT DESCRIPTION

The Cree XLamp® ML-C LED brings lighting-class reliability and performance to 1/3-watt LEDs. The XLamp ML-C LED expands Cree's lighting-class leadership to LED bulbs and linear and distributed lighting applications. With XLamp LED lighting-class reliability, a wide viewing angle, uniform light output, and industry-leading chromaticity binning in a 3.5-mm X 3.5-mm package, the XLamp ML-C LED continues Cree's history of segment-focused product innovation in LEDs for lighting applications.

The XLamp ML-C LED brings high performance and a smooth look to a wide range of lighting applications, including linear lighting, fluorescent retrofits and retail-display lighting.

FEATURES

- Available in white (2600 K to 8300 K CCT), 80-, 85- and 90-CRI minimum and royal blue
- White LEDs available in both parallel and series
- ANSI-compatible sub-bins
- Maximum drive current: 350 mA for parallel, 175 mA for series, 250 mA for royal blue
- 120° viewing angle, uniform chromaticity profile
- Electrically neutral thermal path
- RoHS and REACH compliant
- UL® recognized component (E349212)



TABLE OF CONTENTS

Characteristics	2
Flux Characteristics	3
Relative Spectral Power Distribution	6
Relative Luminous Flux vs. Junction Temperature	7
Relative Radiant Flux vs. Junction Temperature	7
Electrical Characteristics	8
Relative Luminous Flux vs. Current	9
Relative Radiant Flux vs. Current	10
Typical Spatial Distribution	11
Thermal Design	12
Reflow Soldering Characteristics	14
Notes	15
Mechanical Dimensions	17
Tape and Reel	18
Packaging	19

CHARACTERISTICS (T_j = 25 °C)

Characteristics	Unit	Minimum	Typical	Maximum
Thermal resistance, junction to solder point	°C/W		13	
Viewing angle (FWHM) - white	degrees		120	
Viewing angle (FWHM) - royal blue	degrees		125	
Temperature coefficient of voltage - parallel	mV/°C		-3.4	
Temperature coefficient of voltage - series	mV/°C		-6.8	
Temperature coefficient of voltage - royal blue	mV/°C		-3.4	
ESD classification (HBM per Mil-Std-883D) - parallel			Class 2	
ESD withstand voltage (HBM per Mil-Std-883D) - series	V			8000
DC forward current - parallel	mA			350
DC forward current - series	mA			175
DC forward current - royal blue	mA			250
Reverse voltage	V			-5
Forward voltage (@ 100 mA) - parallel	V		3.2	3.4
Forward voltage (@ 50 mA) - series	V		6.4	7.0
Forward voltage (@ 100 mA) - royal blue	V		3.2	3.4
LED junction temperature	°C			150

FLUX CHARACTERISTICS - ML-C PARALLEL WHITE ($T_j = 25\text{ }^\circ\text{C}$)

The following table provides several base order codes for XLamp ML-C LEDs. It is important to note that the base order codes listed here are a subset of the total available order codes for the product family. For more order codes, as well as a complete description of the order-code nomenclature, please consult the XLamp ML Family LED Binning and Labeling document.

Color	CCT Range		Minimum Luminous Flux (lm) @ 100 mA		Calculated Min. Luminous Flux (lm) @ 300 mA *	Order Code
	Minimum	Maximum	Group	Flux (lm)		
Cool White	5000 K	8300 K	K2	30.6	63.1	MLCAWT-A1-0000-000051
			J3	26.8	55.2	MLCAWT-A1-0000-000X51
80-CRI Cool White	6000 K	7000 K	K2	30.6	63.1	MLCAWT-H1-0000-0000E1
			J3	26.8	55.2	MLCAWT-H1-0000-000XE1
	4750 K	5250 K	K2	30.6	63.1	MLCAWT-H1-0000-0000E3
			J3	26.8	55.2	MLCAWT-H1-0000-000XE3
Warm White	3700 K	4300 K	K2	30.6	63.1	MLCAWT-A1-0000-0000E5
			J3	26.8	55.2	MLCAWT-A1-0000-000XE5
	2800 K	3200 K	K2	30.6	63.1	MLCAWT-A1-0000-0000E7
			J3	26.8	55.2	MLCAWT-A1-0000-000XE7
80-CRI Warm White	3700 K	4300 K	J3	26.8	55.2	MLCAWT-H1-0000-000XE5
	2800 K	3200 K	J2	23.5	48.4	MLCAWT-H1-0000-000WE7
85-CRI Warm White	3700 K	4300 K	J3	26.8	55.2	MLCAWT-P1-0000-000XE5
	2800 K	3200 K	J2	23.5	48.4	MLCAWT-P1-0000-000WE7
90-CRI Warm White	3700 K	4300 K	H0	18.1	37.3	MLCAWT-U1-0000-000VE5
	2800 K	3200 K	J2	23.5	48.4	MLCAWT-U1-0000-000WE7

Notes:

- Cree maintains a tolerance of $\pm 7\%$ on flux and power measurements, ± 0.005 on chromaticity (CCx, CCy) measurements and ± 2 on CRI measurements. See the Measurements section (page 15).
 - Typical CRI for Cool White (4300 K – 8300 K CCT) is 75.
 - Typical CRI for Warm White (2600 K – 4300 K CCT) is 80.
 - Minimum CRI for 80-CRI White is 80.
 - Minimum CRI for 85-CRI White is 85.
 - Minimum CRI for 90-CRI White is 90
- * Calculated flux values are for reference only.

FLUX CHARACTERISTICS - ML-C SERIES WHITE (T_j = 25 °C)

The following table provides several base order codes for XLamp ML-C LEDs. It is important to note that the base order codes listed here are a subset of the total available order codes for the product family. For more order codes, as well as a complete description of the order-code nomenclature, please consult the XLamp ML Family LED Binning and Labeling document.

Color	CCT Range		Minimum Luminous Flux (lm) @ 50 mA		Calculated Min. Luminous Flux (lm) @ 150 mA *	Order Code
	Minimum	Maximum	Group	Flux (lm)		
Cool White	5000 K	8300 K	K2	30.6	63.1	MLCSWT-A1-0000-000051
			J3	26.8	55.2	MLCSWT-A1-0000-000X51
80-CRI Cool White	6000 K	7000 K	K2	30.6	63.1	MLCSWT-H1-0000-0000E1
			J3	26.8	55.2	MLCSWT-H1-0000-000XE1
	4750 K	5250 K	K2	30.6	63.1	MLCSWT-H1-0000-0000E3
			J3	26.8	55.2	MLCSWT-H1-0000-000XE3
Warm White	3700 K	4300 K	K2	30.6	63.1	MLCSWT-A1-0000-0000E5
			J3	26.8	55.2	MLCSWT-A1-0000-000XE5
	2800 K	3200 K	K2	30.6	63.1	MLCSWT-A1-0000-0000E7
			J3	26.8	55.2	MLCSWT-A1-0000-000XE7
80-CRI Warm White	3700 K	4300 K	J3	26.8	55.2	MLCSWT-H1-0000-000XE5
	2800 K	3200 K	J2	23.5	48.4	MLCSWT-H1-0000-000WE7
85-CRI Warm White	3700 K	4300 K	J3	26.8	55.2	MLCSWT-P1-0000-000XE5
	2800 K	3200 K	J2	23.5	48.4	MLCSWT-P1-0000-000WE7
90-CRI Warm White	3700 K	4300 K	H0	18.1	37.3	MLCSWT-U1-0000-000VE5
	2800 K	3200 K	J2	23.5	48.4	MLCSWT-U1-0000-000WE7

Notes:

- Cree maintains a tolerance of $\pm 7\%$ on flux and power measurements, ± 0.005 on chromaticity (CC_x, CC_y) measurements and ± 2 on CRI measurements. See the Measurements section (page 15).
 - Typical CRI for Cool White (4300 K – 8300 K CCT) is 75.
 - Typical CRI for Warm White (2600 K – 4300 K CCT) is 80.
 - Minimum CRI for 80-CRI White is 80.
 - Minimum CRI for 85-CRI White is 85.
 - Minimum CRI for 90-CRI White is 90
- * Calculated flux values are for reference only.

FLUX CHARACTERISTICS - ML-C ROYAL BLUE (T_j = 25 °C)

The following table provides a base order code for XLamp ML-C Royal Blue LEDs. It is important to note that the base order codes listed here are a subset of the total available order codes for the product family. For more order codes, as well as a complete description of the order-code nomenclature, please consult the XLamp ML Family LED Binning and Labeling document.

Color	Dominant Wavelength Range				Minimum Radiant Flux (mW) @ 100 mA		Order Code
	Minimum		Maximum		Group	Flux (mW)	
	Group	DWL (nm)	Group	DWL (nm)			
Royal Blue	D3	450	D5	465	07	100	MLCROY-A1-0000-000201

- Note:**
- Cree maintains a tolerance of ±7% on flux and power measurements, ±0.005 on chromaticity (CCx, CCy) measurements and ±2 on CRI measurements and ±1 nm on dominant wavelength measurements. See the Measurements section (page 15).

RELATIVE SPECTRAL POWER DISTRIBUTION - WHITE

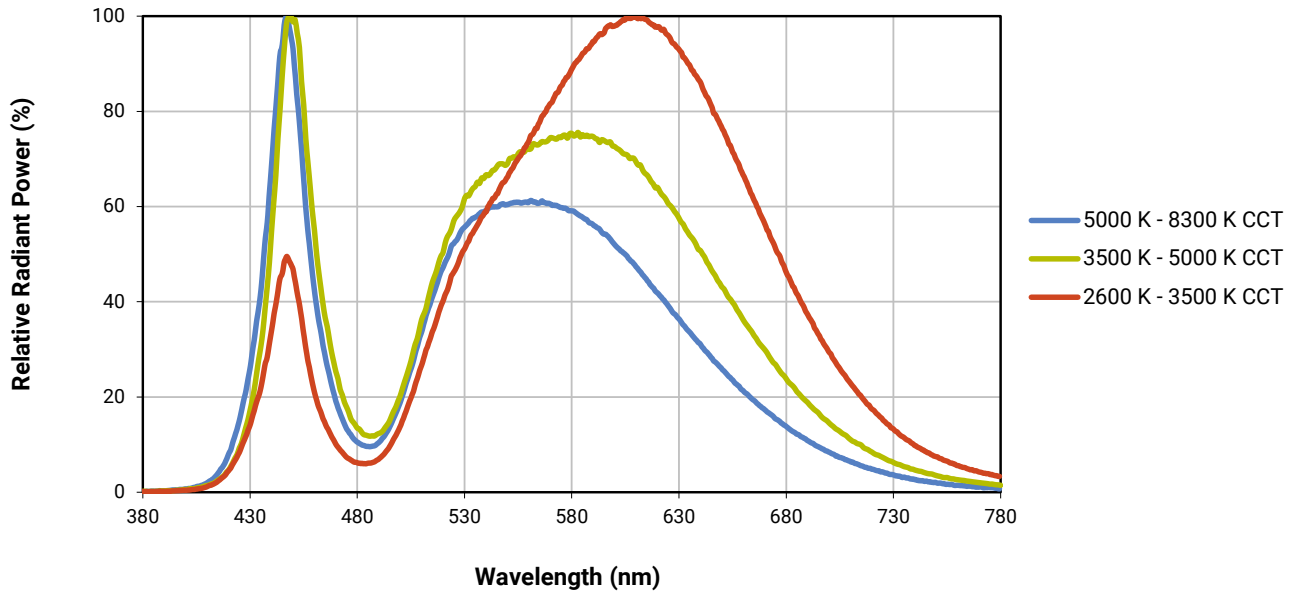

RELATIVE SPECTRAL POWER DISTRIBUTION - ROYAL BLUE

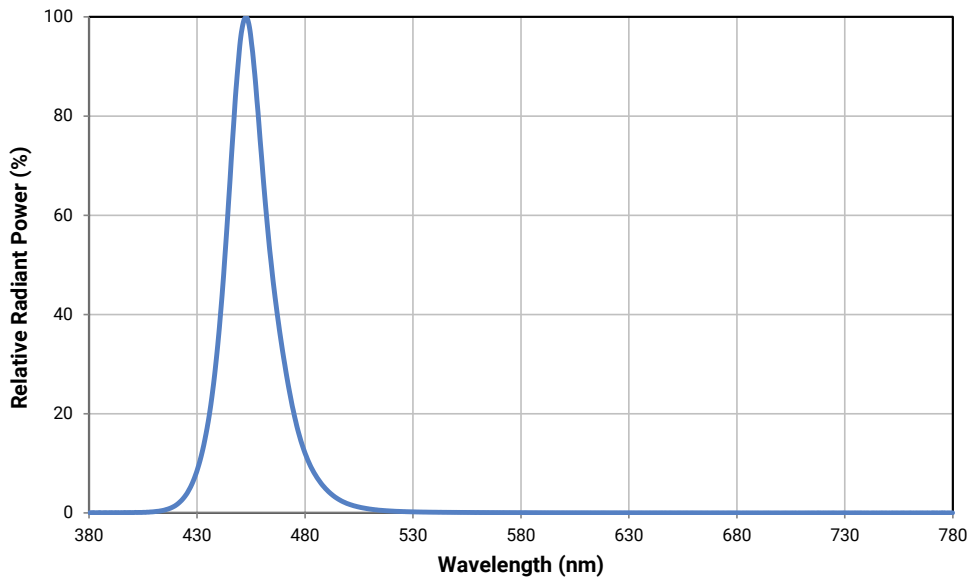

RELATIVE LUMINOUS FLUX VS. JUNCTION TEMPERATURE - WHITE (ML-C PARALLEL: $I_F = 100$ mA, ML-C SERIES: $I_F = 50$ mA)

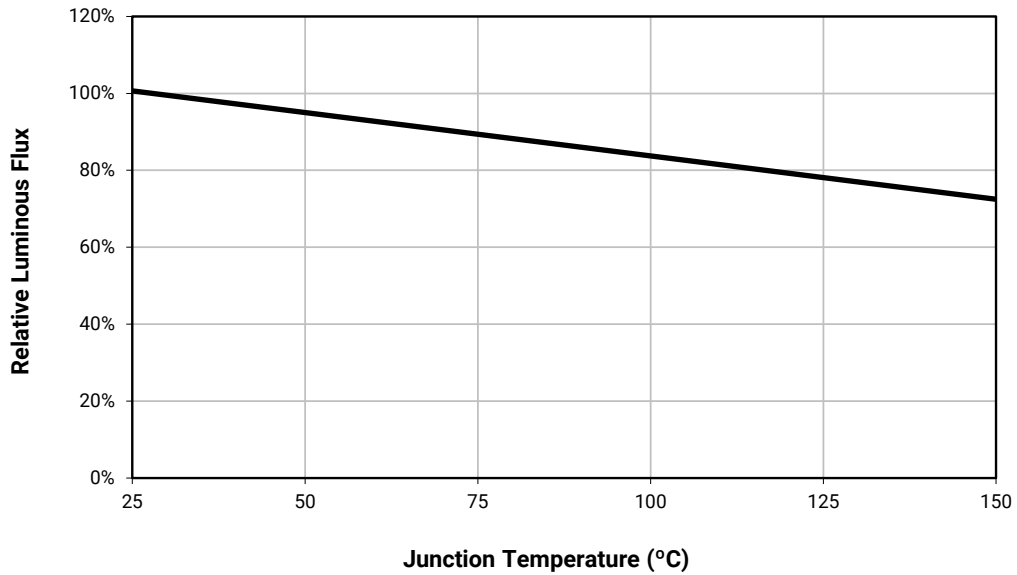

RELATIVE RADIANT FLUX VS. JUNCTION TEMPERATURE - ROYAL BLUE ($I_F = 100$ mA)

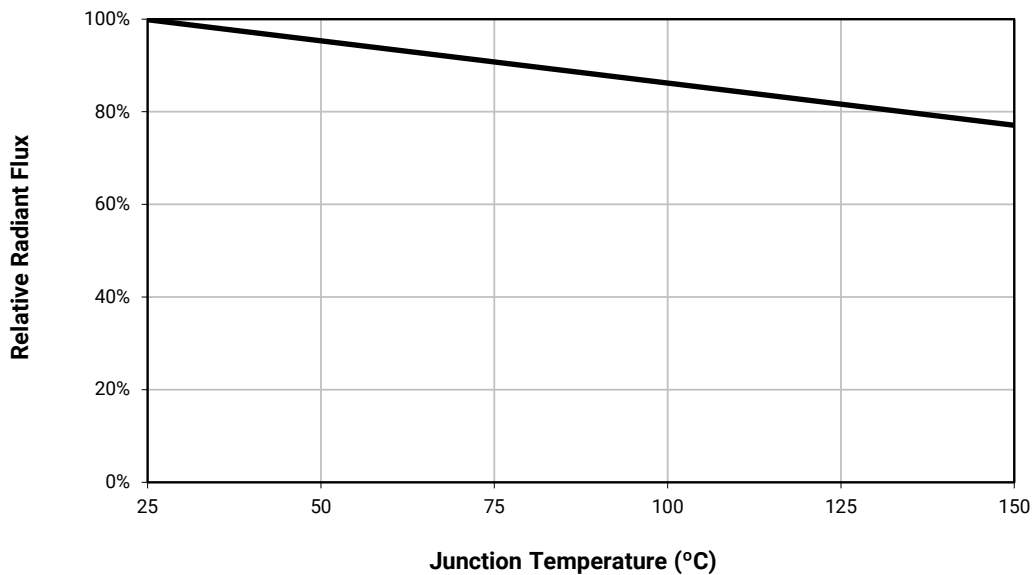

ELECTRICAL CHARACTERISTICS - ML-C PARALLEL WHITE ($T_j = 25\text{ }^\circ\text{C}$)

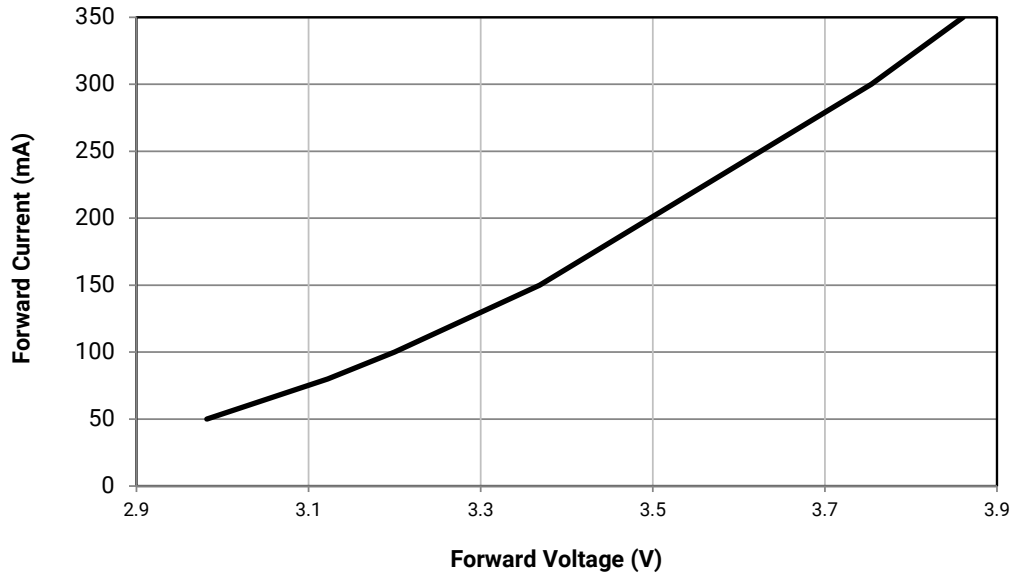

ELECTRICAL CHARACTERISTICS - ML-C SERIES WHITE ($T_j = 25\text{ }^\circ\text{C}$)

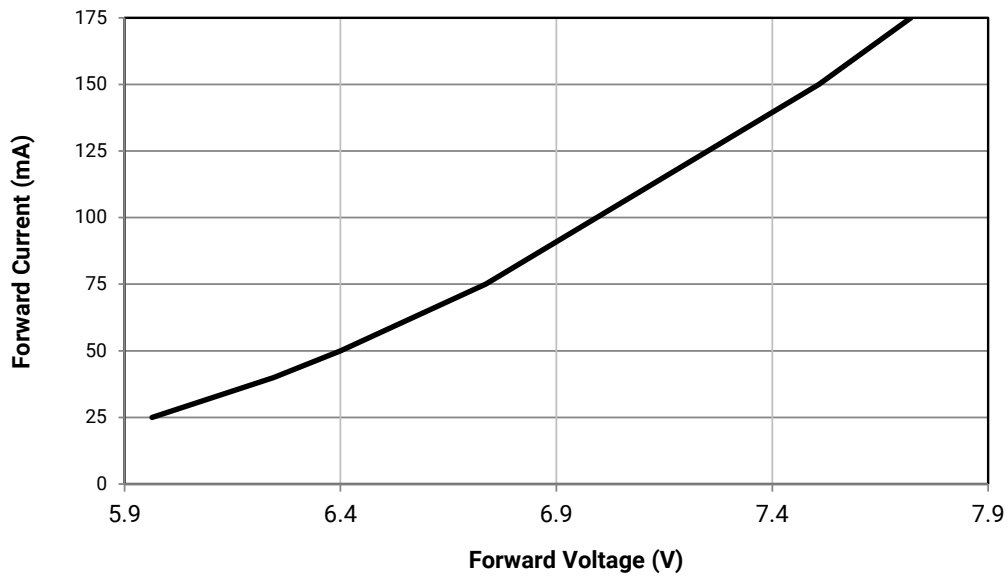

ELECTRICAL CHARACTERISTICS - ROYAL BLUE ($T_j = 25\text{ }^\circ\text{C}$)

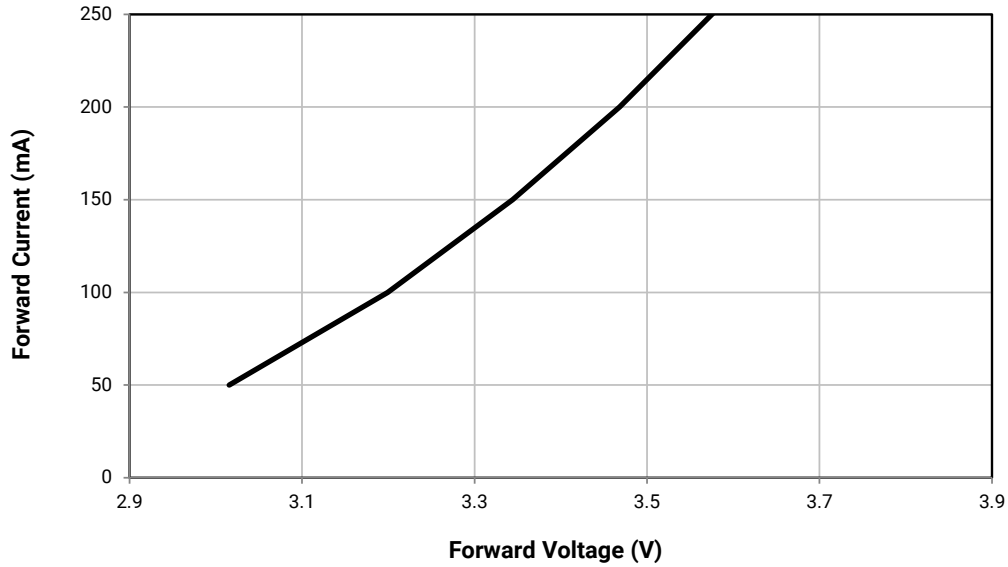

RELATIVE LUMINOUS FLUX VS. CURRENT - ML-C PARALLEL WHITE ($T_j = 25\text{ }^\circ\text{C}$)

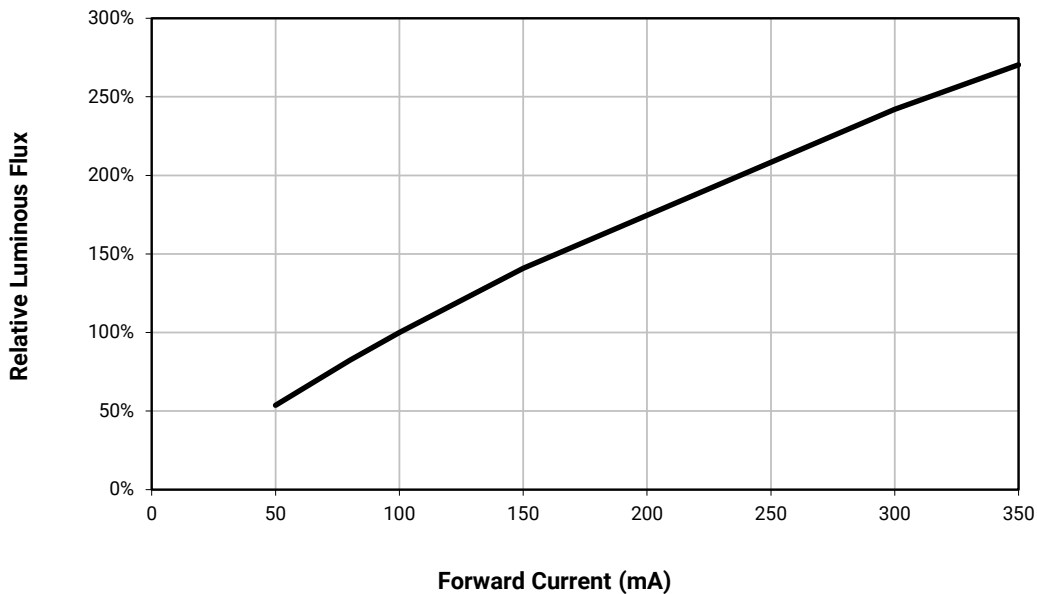

RELATIVE LUMINOUS FLUX VS. CURRENT - ML-C SERIES WHITE ($T_j = 25\text{ }^\circ\text{C}$)

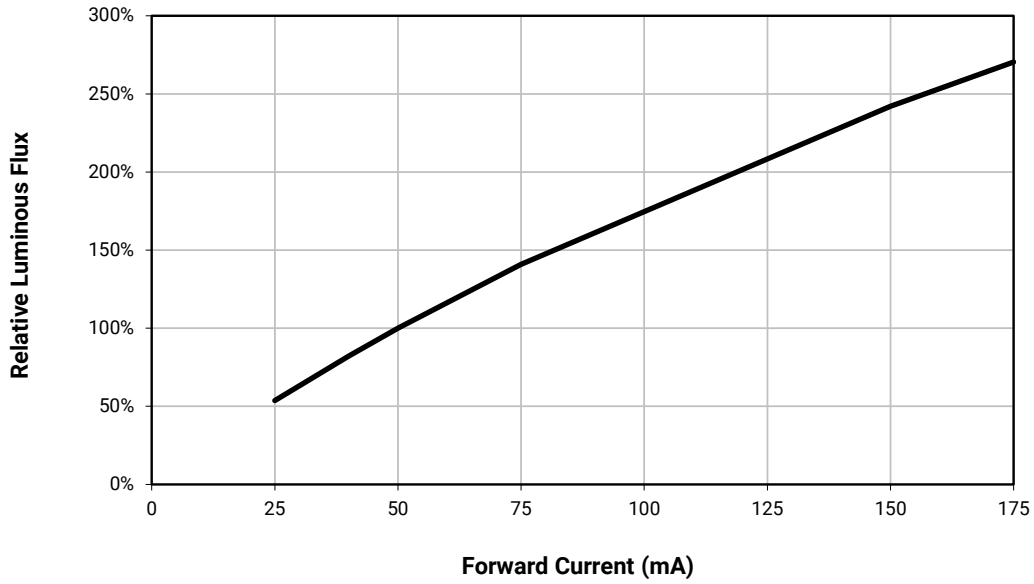

RELATIVE RADIANT FLUX VS. CURRENT - ROYAL BLUE ($T_j = 25\text{ }^\circ\text{C}$)

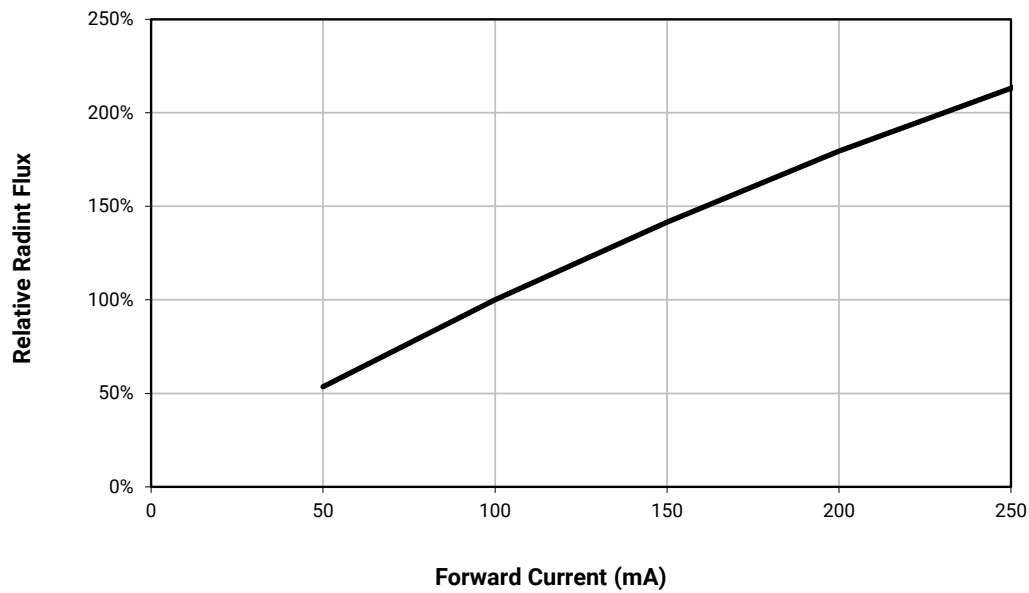

TYPICAL SPATIAL DISTRIBUTION - WHITE

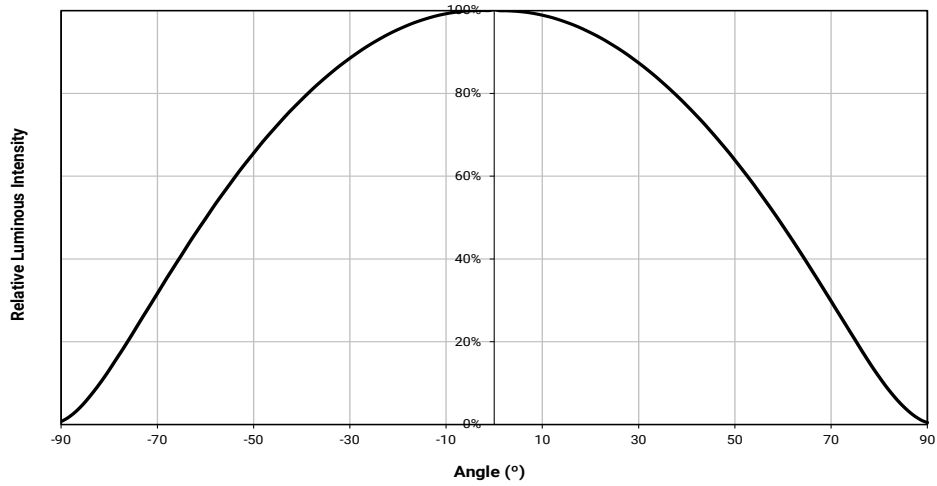

TYPICAL SPATIAL DISTRIBUTION - ROYAL BLUE

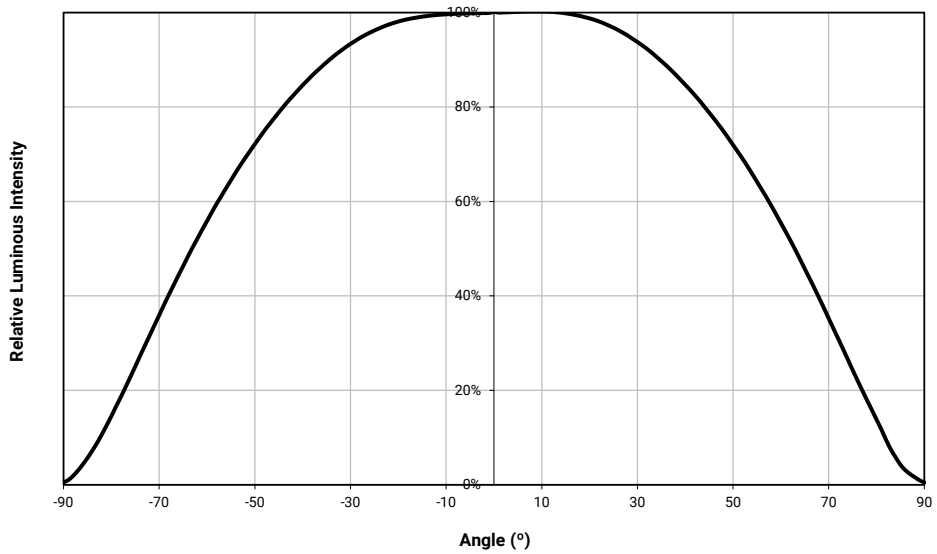

THERMAL DESIGN - ML-C PARALLEL WHITE

The maximum forward current is determined by the thermal resistance between the LED junction and ambient. It is crucial for the end product to be designed in a manner that minimizes the thermal resistance from the solder point to ambient in order to optimize lamp life and optical characteristics.

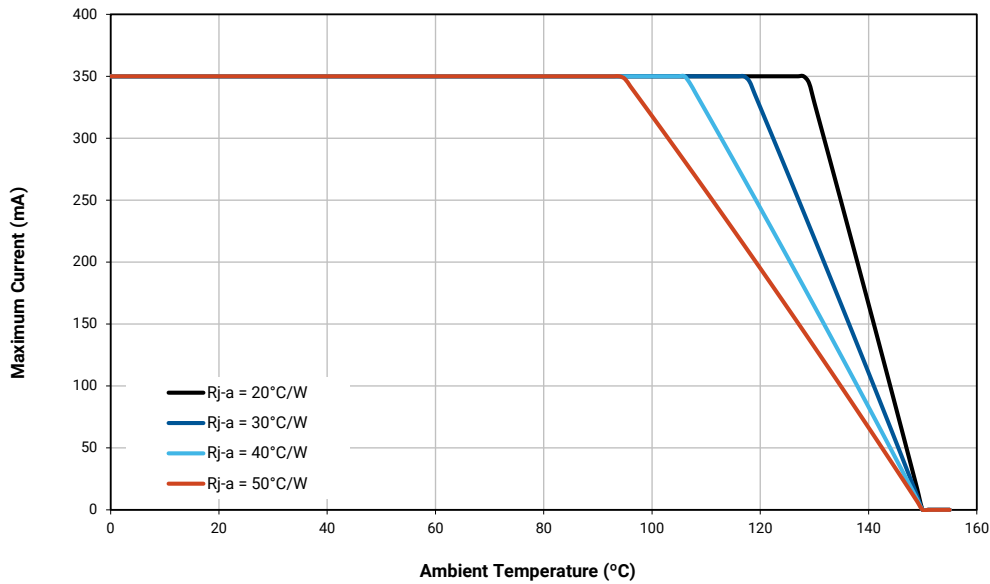

THERMAL DESIGN - ML-C SERIES WHITE

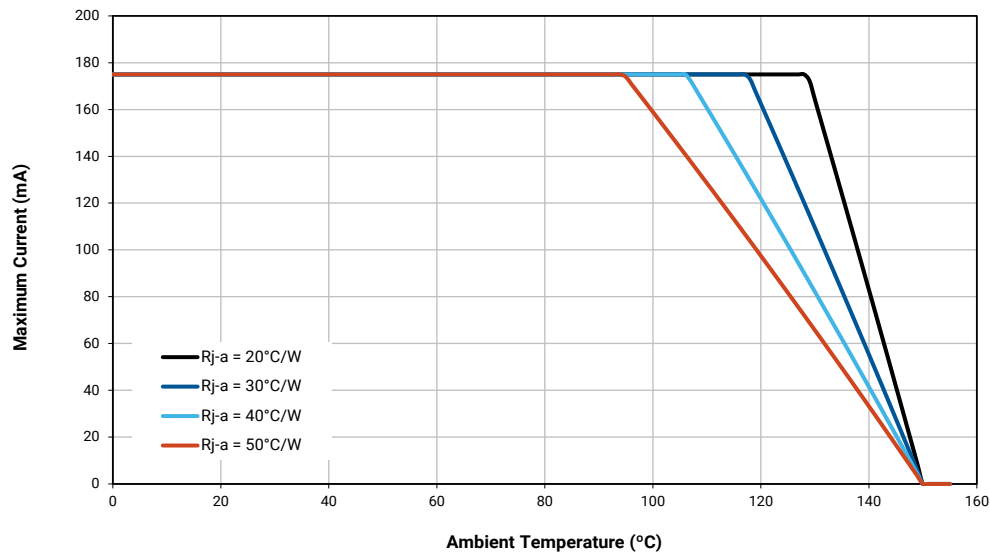

THERMAL DESIGN - ROYAL BLUE

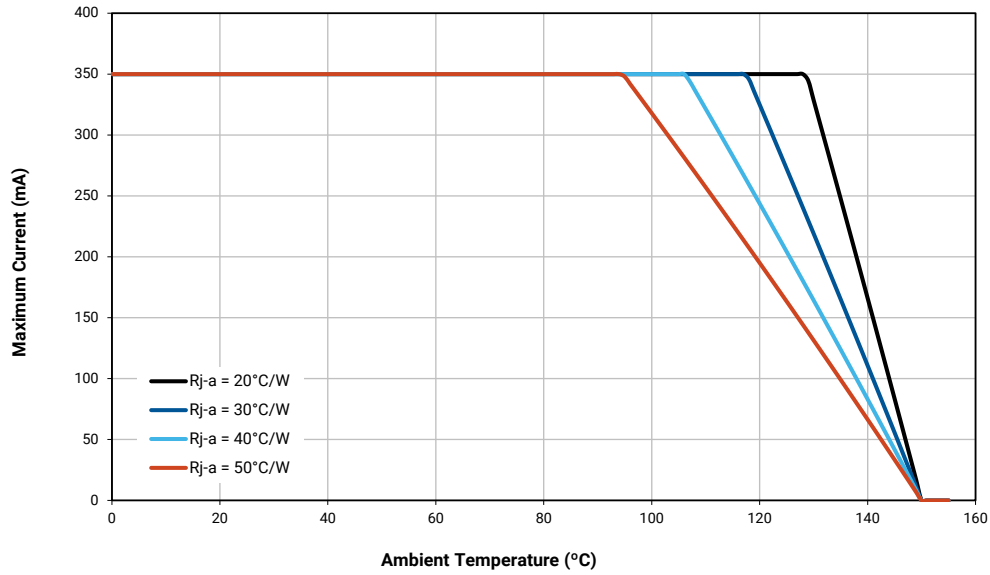

REFLOW SOLDERING CHARACTERISTICS

In testing, Cree has found XLamp ML-C LEDs to be compatible with JEDEC J-STD-020C, using the parameters listed below. As a general guideline, Cree recommends that users follow the recommended soldering profile provided by the manufacturer of the solder paste used.

Note that this general guideline may not apply to all PCB designs and configurations of reflow soldering equipment.

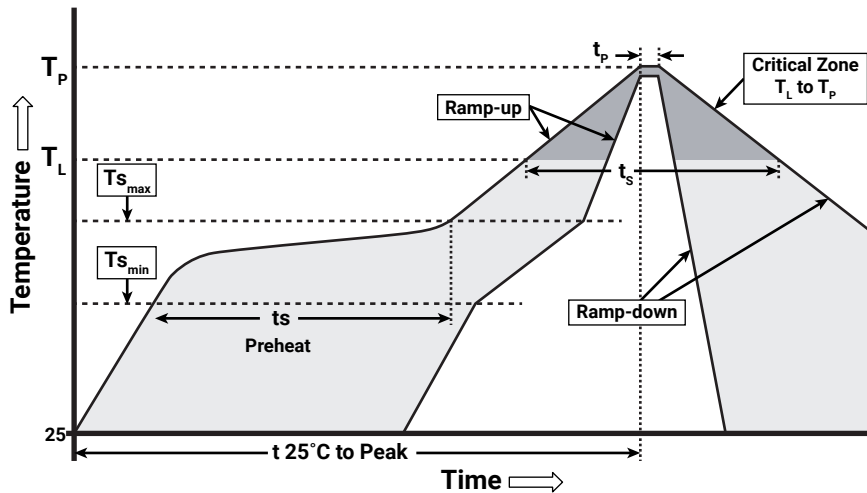

IPC/JEDEC J-STD-020C

Profile Feature	Lead-Free Solder
Average Ramp-Up Rate ($T_{s_{max}}$ to T_p)	1.2 °C/second
Preheat: Temperature Min ($T_{s_{min}}$)	120 °C
Preheat: Temperature Max ($T_{s_{max}}$)	170 °C
Preheat: Time ($t_{s_{min}}$ to $t_{s_{max}}$)	65-150 seconds
Time Maintained Above: Temperature (T_L)	217 °C
Time Maintained Above: Time (t_L)	45-90 seconds
Peak/Classification Temperature (T_p)	235 - 245 °C
Time Within 5 °C of Actual Peak Temperature (t_p)	20-40 seconds
Ramp-Down Rate	1 - 6 °C/second
Time 25 °C to Peak Temperature	4 minutes max.

Note: All temperatures refer to topside of the package, measured on the package body surface.

Note: While the high reflow temperatures (above) have been approved, Cree’s best practice guideline for reflow is to use as low a temperature as possible during the reflow soldering process for these LEDs.

NOTES

Measurements

The luminous flux, radiant power, chromaticity, forward voltage and CRI measurements in this document are binning specifications only and solely represent product measurements as of the date of shipment. These measurements will change over time based on a number of factors that are not within Cree’s control and are not intended or provided as operational specifications for the products. Calculated values are provided for informational purposes only and are not intended as specifications.

Pre-Release Qualification Testing

Please read the [LED Reliability Overview](#) for details of the qualification process Cree applies to ensure long-term reliability for XLamp LEDs and details of Cree’s pre-release qualification testing for XLamp LEDs.

Lumen Maintenance

Cree now uses standardized IES LM-80-08 and TM-21-11 methods for collecting long-term data and extrapolating LED lumen maintenance. For information on the specific LM-80 data sets available for this LED, refer to the public [LM-80 results document](#).

Please read the [Long-Term Lumen Maintenance application note](#) for more details on Cree’s lumen maintenance testing and forecasting. Please read the [Thermal Management application note](#) for details on how thermal design, ambient temperature, and drive current affect the LED junction temperature.

Moisture Sensitivity

Cree recommends keeping XLamp ML-C LEDs in the provided, resealable moisture-barrier packaging (MBP) until immediately prior to soldering. Unopened MBPs that contain XLamp LEDs do not need special storage for moisture sensitivity.

Once the MBP is opened, XLamp ML-C LEDs should be handled and stored as MSL 2a per JEDEC J-STD-033, meaning they have limited exposure time before damage to the LED may occur during the soldering operation. The table on the right specifies the maximum exposure time in days depending on temperature and humidity conditions. LEDs with exposure time longer than the specified maximums must be baked according to the baking conditions listed below.

Temp.	Maximum Percent Relative Humidity						
	30%	40%	50%	60%	70%	80%	90%
35 °C	-	-	-	17	1	.5	.5
30 °C	-	-	-	28	1	1	1
25 °C	-	-	-	-	2	1	1
20 °C	-	-	-	-	2	1	1

Baking Conditions

It is not necessary to bake all XLamp ML-C LEDs. Only the LEDs that meet all of the following criteria must be baked:

1. LEDs that have been removed from the original MBP.
2. LEDs that have been exposed to a humid environment longer than listed in the Moisture Sensitivity section above.
3. LEDs that have not been soldered.

NOTES - CONTINUED

LEDs should be baked at 70 °C for 24 hours. LEDs may be baked on the original reels. Remove LEDs from the MBP before baking. Do not bake parts at temperatures higher than 70 °C. This baking operation resets the exposure time as defined in the Moisture Sensitivity section above.

Storage Conditions

XLamp ML-C LEDs that have been removed from the original MBP but not soldered should be stored in one of the following ways:

- Store the parts in a rigid metal container with a tight-fitting lid. Verify that the storage temperature is <30 °C, and place fresh desiccant and an RH indicator in the container to verify that the RH is no greater than 60%.
- Store the parts in a dry, nitrogen-purged cabinet or container that actively maintains the temperature at <30° and the RH at no greater than 60%.
- For short-term store only: LEDs can be resealed in the original MBP soon after opening. Fresh desiccant may be needed. Use the included humidity indicator card to verify <60% RH.

If an environment of <60% RH is not available for storage, XLamp ML-C LEDs should be baked (described above) before reflow soldering.

RoHS Compliance

The levels of RoHS restricted materials in this product are below the maximum concentration values (also referred to as the threshold limits) permitted for such substances, or are used in an exempted application, in accordance with EU Directive 2011/65/EC (RoHS2), as implemented January 2, 2013. RoHS Declarations for this product can be obtained from your Cree representative or from the Product Documentation sections of www.cree.com.

REACH Compliance

REACH substances of very high concern (SVHCs) information is available for this product. Since the European Chemical Agency (ECHA) has published notice of their intent to frequently revise the SVHC listing for the foreseeable future, please contact a Cree representative to insure you get the most up-to-date REACH SVHC Declaration. REACH banned substance information (REACH Article 67) is also available upon request.

UL® Recognized Component

Level 4 enclosure consideration. The LED package or a portion thereof has been investigated as a fire and electrical enclosure per ANSI/UL 8750.

Vision Advisory

WARNING. Do not look at exposed LED lamps in operation. Eye injury can result. For more information about LEDs and eye safety, please refer to the [LED Eye Safety application note](#).

MECHANICAL DIMENSIONS (T_A = 25 °C)

All measurements are ±.13 mm unless otherwise indicated.

Top View

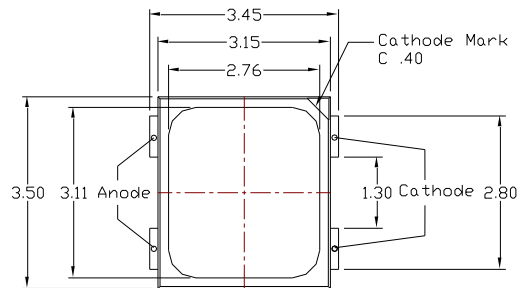
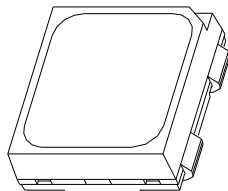

Top View

Bottom View

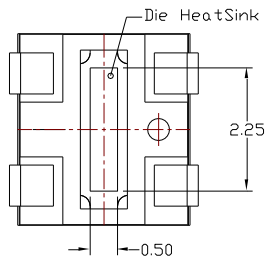

Side View

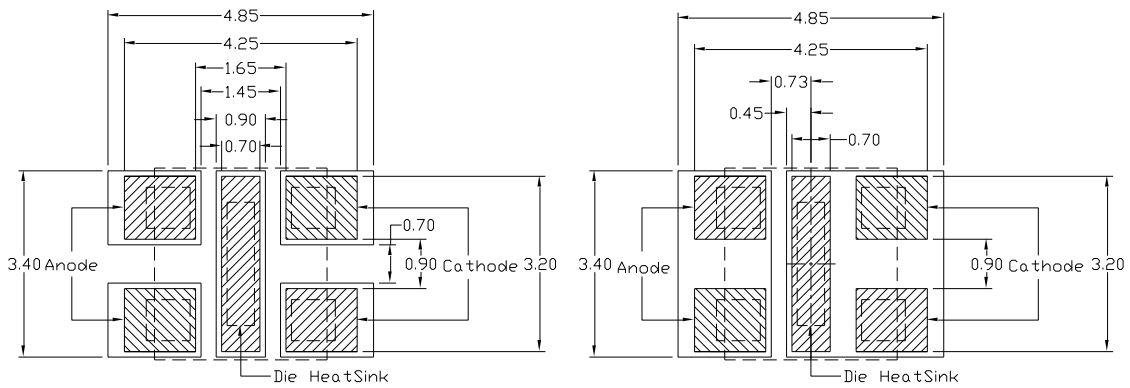
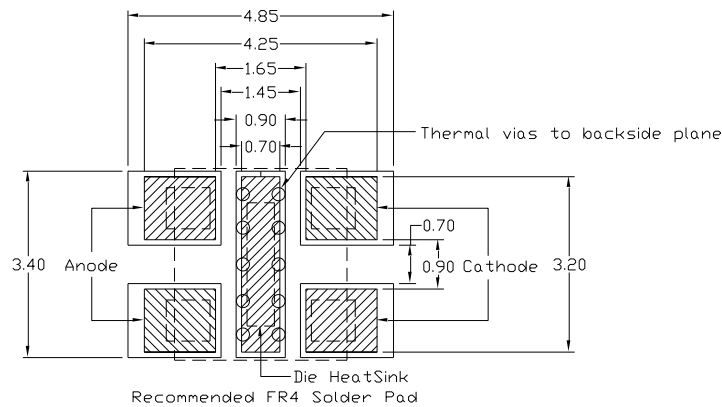
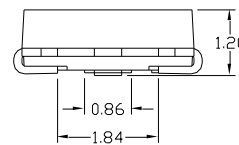

Recommended MCPCB Solder Pad

Alternative Solder Pad

TAPE AND REEL

All Cree carrier tapes conform to EIA-481D, Automated Component Handling Systems Standard.

Except as noted, all dimensions in mm.

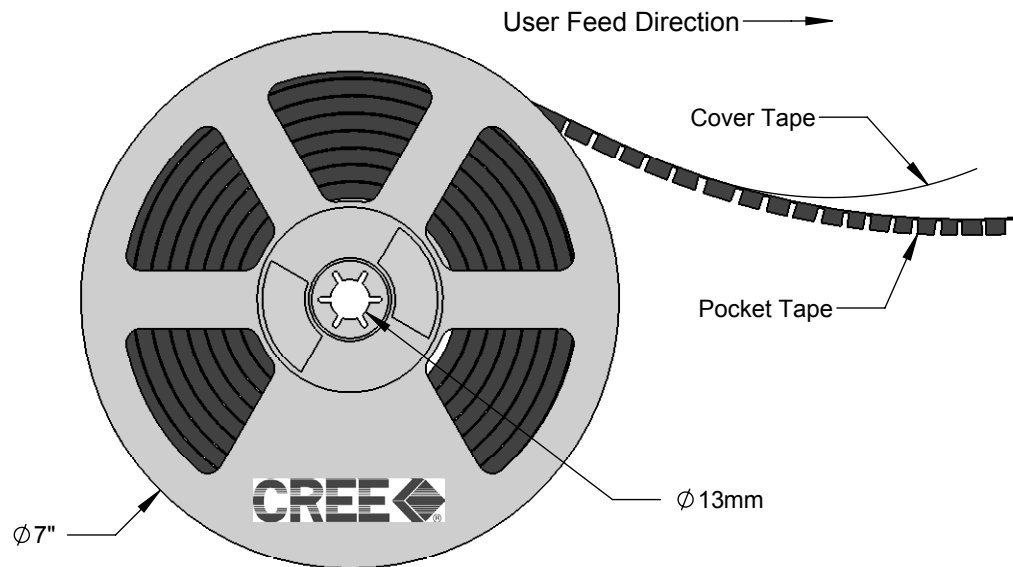
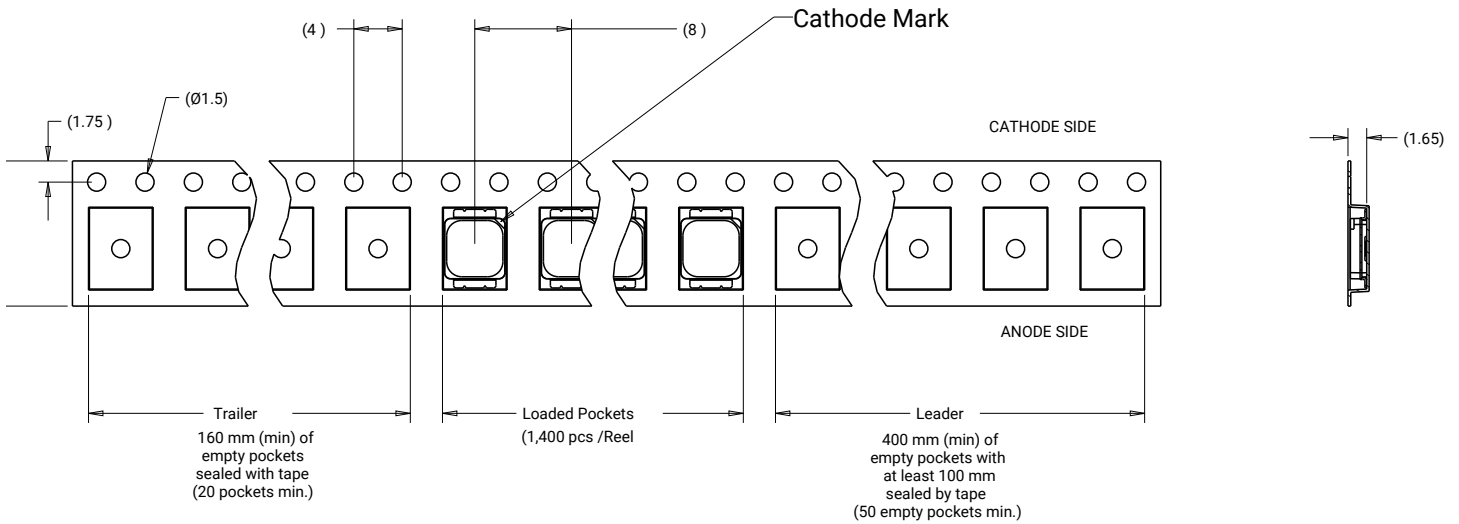

PACKAGING

Unpackaged Reel

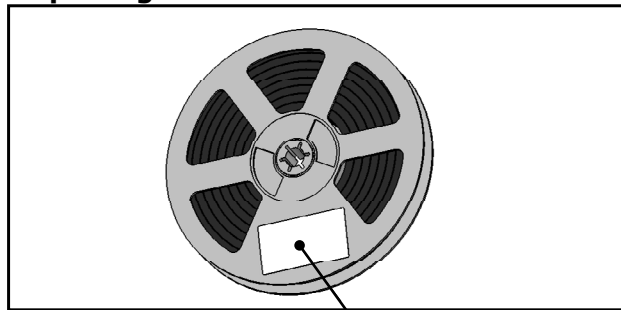

Label with Cree Bin Code,
Quantity, Reel ID

Packaged Reel

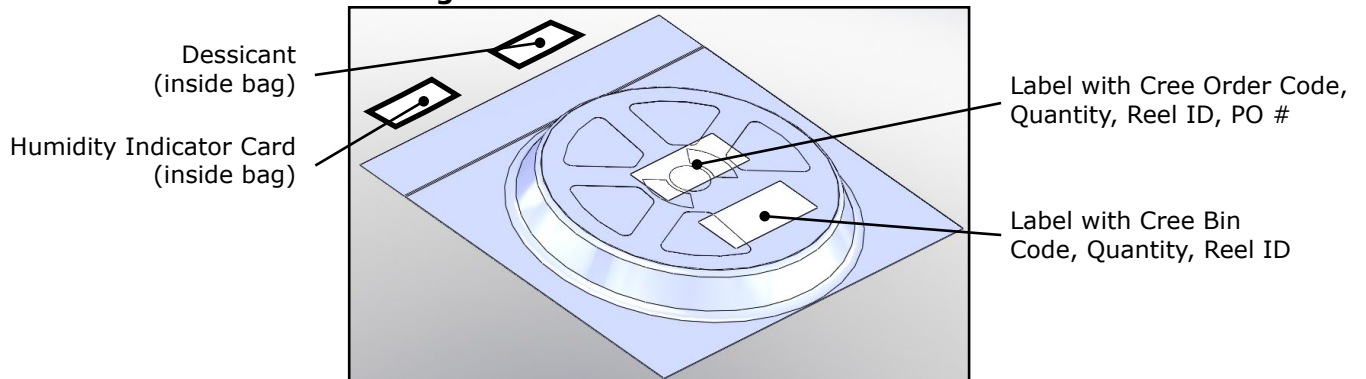

Dessicant
(inside bag)

Humidity Indicator Card
(inside bag)

Label with Cree Order Code,
Quantity, Reel ID, PO #

Label with Cree Bin
Code, Quantity, Reel ID

Boxed Reel

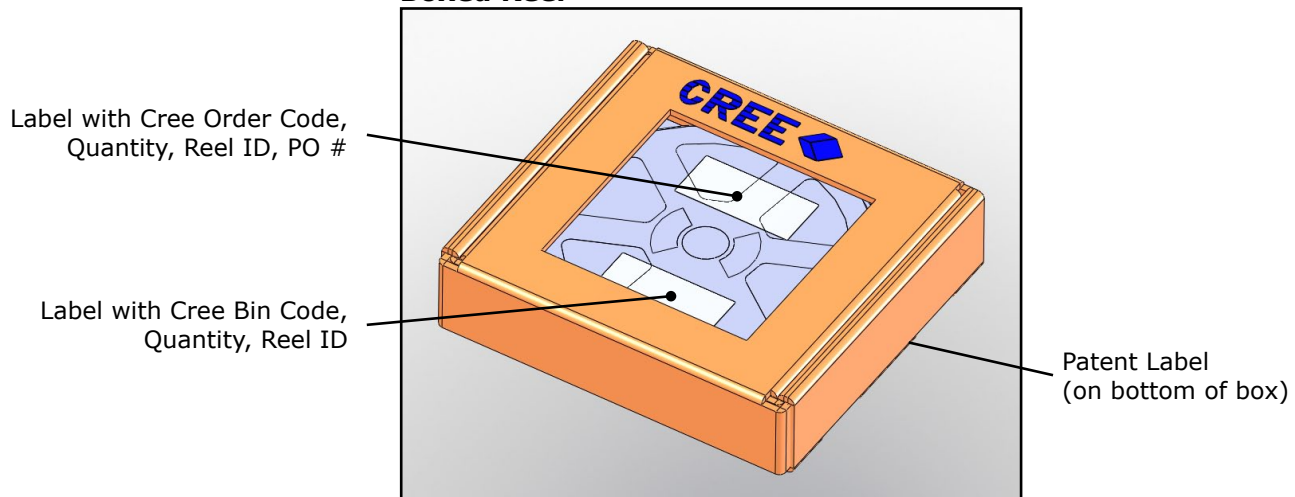

Label with Cree Order Code,
Quantity, Reel ID, PO #

Label with Cree Bin Code,
Quantity, Reel ID

Patent Label
(on bottom of box)