

Cree® XLamp® ML-E LEDs



PRODUCT DESCRIPTION

The Cree XLamp® ML-E LED brings lighting-class reliability and performance to ½-watt LEDs. The XLamp ML-E LED expands Cree’s lighting-class leadership to LED bulbs and linear and distributed lighting applications. With XLamp LED lighting-class reliability, a wide viewing angle, uniform light output, and industry-leading chromaticity binning in a 3.5-mm X 3.5-mm package, the XLamp ML-E LED continues Cree’s history of segment-focused product innovation in LEDs for lighting applications.

The XLamp ML-E LED brings high performance and a smooth look to a wide range of lighting applications, including linear lighting, LED light bulbs, fluorescent retrofits and retail-display lighting.

FEATURES

- Available in white (2600 K to 8300 K CCT), 80-, 85- and 90-CRI minimum
- Available in royal blue, blue, green, amber and red
- Available in parallel and series Vf configurations for white and color
- ANSI-compatible sub-bins
- Maximum drive current: 500 mA for parallel white, 167 mA for series white, 350 mA for parallel royal blue, blue, green and red, 250 mA for parallel amber, 120 mA for series blue and green, 65 mA for series amber, 88 mA for series red
- 120° viewing angle for white, 125° viewing angle for color
- Uniform chromaticity profile
- Electrically neutral thermal path
- RoHS and REACH compliant
- UL® recognized component (E349212)

TABLE OF CONTENTS

| | |
|---|----|
| Characteristics | 2 |
| Flux Characteristics | 3 |
| Relative Spectral Power Distribution | 7 |
| Relative Luminous Flux vs. Junction Temperature | 8 |
| Relative Radiant Flux vs. Junction Temperature | 9 |
| Electrical Characteristics..... | 10 |
| Relative Luminous Flux vs. Current..... | 12 |
| Relative Radiant Flux vs. Current | 14 |
| Typical Spatial Distribution..... | 14 |
| Thermal Design | 16 |
| Reflow Soldering Characteristics..... | 21 |
| Notes | 22 |
| Mechanical Dimensions | 24 |
| Tape and Reel..... | 26 |
| Packaging..... | 27 |



CHARACTERISTICS (T_j = 25 °C)

| Characteristics | Unit | Minimum | Typical | Maximum |
|---|---------|---------|---------|---------|
| Thermal resistance, junction to solder point - white, royal blue, blue | °C/W | | 11 | |
| Thermal resistance, junction to solder point - green, red | °C/W | | 15 | |
| Thermal resistance, junction to solder point - amber | °C/W | | 24 | |
| Viewing angle (FWHM) - white | degrees | | 120 | |
| Viewing angle (FWHM) - royal blue, blue, green, amber, red | degrees | | 125 | |
| Temperature coefficient of voltage - parallel - white, royal blue, blue | mV/°C | | -3.3 | |
| Temperature coefficient of voltage - series - white, blue | mV/°C | | -10 | |
| Temperature coefficient of voltage - parallel - green | mV/°C | | -4 | |
| Temperature coefficient of voltage - series - green | mV/°C | | -11 | |
| Temperature coefficient of voltage - parallel - amber | mV/°C | | -1 | |
| Temperature coefficient of voltage - series - amber | mV/°C | | -3.2 | |
| Temperature coefficient of voltage - parallel - red | mV/°C | | -1.8 | |
| Temperature coefficient of voltage - series - red | mV/°C | | -5.4 | |
| ESD withstand voltage (HBM per Mil-Std-883D) - white, royal blue, blue, green | V | | | 8000 |
| ESD classification (HBM per Mil-Std-883D) - amber, red | | | Class 2 | |
| DC forward current - parallel - white | mA | | | 500 |
| DC forward current - series - white | mA | | | 167 |
| DC forward current - parallel - royal blue, blue, green, red | mA | | | 350 |
| DC forward current - series - blue, green | mA | | | 120 |
| DC forward current - parallel - amber | mA | | | 250 |
| DC forward current - series - amber | mA | | | 65 |
| DC forward current - series - red | mA | | | 88 |
| Reverse voltage | V | | | -5 |
| Forward voltage (@ 150 mA) - parallel - white | V | | 3.2 | 3.4 |
| Forward voltage (@ 50 mA) - series - white | V | | 9.6 | 10.2 |
| Forward voltage (@ 150 mA) - parallel - royal blue, blue | V | | 3.2 | |
| Forward voltage (@ 50 mA) - series - blue | V | | 9.6 | |
| Forward voltage (@ 150 mA) - parallel - green | V | | 3.3 | |
| Forward voltage (@ 50 mA) - series - green | V | | 9.9 | |
| Forward voltage (@ 150 mA) - parallel - amber, red | V | | 2.4 | |
| Forward voltage (@ 37.5 mA) - series - amber, red | V | | 9.6 | |
| LED junction temperature | °C | | | 150 |

FLUX CHARACTERISTICS - PARALLEL WHITE ($T_j = 25\text{ }^\circ\text{C}$)

The following table provides several base order codes for XLamp ML-E LEDs. It is important to note that the base order codes listed here are a subset of the total available order codes for the product family. For more order codes, as well as a complete description of the order-code nomenclature, please consult the XLamp ML LED Family Binning and Labeling document.

| Color | CCT Range | | Minimum Luminous Flux (lm) @ 150 mA | | Calculated Minimum Luminous Flux (lm)* | | Order Code |
|-------------------|-----------|---------|-------------------------------------|-----------|--|--------|-----------------------|
| | Minimum | Maximum | Group | Flux (lm) | 350 mA | 500 mA | |
| Cool White | 5000 K | 8300 K | N2 | 51.7 | 104.8 | 132.9 | MLEAWT-A1-0000-000451 |
| | | | M3 | 45.7 | 92.6 | 117.4 | MLEAWT-A1-0000-000351 |
| 80-CRI Cool White | 6000 K | 7000 K | M3 | 45.7 | 92.6 | 117.4 | MLEAWT-H1-0000-0003E1 |
| | 4750 K | 5250 K | M3 | 45.7 | 92.6 | 117.4 | MLEAWT-H1-0000-0003E3 |
| Warm White | 3700 K | 4300 K | M3 | 45.7 | 92.6 | 117.4 | MLEAWT-A1-0000-0003E5 |
| | | | M2 | 39.8 | 80.7 | 102.3 | MLEAWT-A1-0000-0002E5 |
| | 2800 K | 3200 K | M2 | 39.8 | 80.7 | 102.3 | MLEAWT-A1-0000-0002E7 |
| | | | K3 | 35.2 | 71.4 | 90.5 | MLEAWT-A1-0000-0001E7 |
| 80-CRI Warm White | 3700 K | 4300 K | M2 | 39.8 | 80.7 | 102.3 | MLEAWT-H1-0000-0002E5 |
| | 2800 K | 3200 K | K3 | 35.2 | 71.4 | 90.5 | MLEAWT-H1-0000-0001E7 |
| 85-CRI Warm White | 2800 K | 3200 K | K3 | 35.2 | 71.4 | 90.5 | MLEAWT-P1-0000-0001E7 |
| 90-CRI Warm White | 2800 K | 3200 K | K2 | 30.6 | 62 | 78.6 | MLEAWT-U1-0000-0000E7 |

Notes:

- Cree maintains a tolerance of $\pm 7\%$ on flux and power measurements, ± 0.005 on chromaticity (CCx, CCy) measurements and ± 2 on CRI measurements. See the Measurements section (page 22).
- Typical CRI for Cool White (4300 K – 8300 K CCT) is 75.
- Typical CRI for Warm White (2600 K – 4300 K CCT) is 80.
- Minimum CRI for 80-CRI White is 80.
- Minimum CRI for 85-CRI White is 85.
- Minimum CRI for 90-CRI White is 90
- * Calculated flux values are for reference only.

FLUX CHARACTERISTICS - SERIES WHITE ($T_j = 25\text{ }^\circ\text{C}$)

The following table provides several base order codes for XLamp ML-E LEDs. It is important to note that the base order codes listed here are a subset of the total available order codes for the product family. For more order codes, as well as a complete description of the order-code nomenclature, please consult the XLamp ML LED Family Binning and Labeling document.

| Color | CCT Range | | Minimum Luminous Flux (lm) @ 50 mA | | Calculated Minimum Luminous Flux (lm)* | | Order Code |
|-------------------|-----------|---------|------------------------------------|-----------|--|--------|-----------------------|
| | Minimum | Maximum | Group | Flux (lm) | 117 mA | 166 mA | |
| Cool White | 5000 K | 8300 K | N2 | 51.7 | 104.8 | 132.9 | MLESWT-A1-0000-000451 |
| | | | M3 | 45.7 | 92.6 | 117.4 | MLESWT-A1-0000-000351 |
| 80-CRI Cool White | 6000 K | 7000 K | M3 | 45.7 | 92.6 | 117.4 | MLESWT-H1-0000-0003E1 |
| | 4750 K | 5250 K | M3 | 45.7 | 92.6 | 117.4 | MLESWT-H1-0000-0003E3 |
| Warm White | 3700 K | 4300 K | M3 | 45.7 | 92.6 | 117.4 | MLESWT-A1-0000-0003E5 |
| | | | M2 | 39.8 | 80.7 | 102.3 | MLESWT-A1-0000-0002E5 |
| | 2800 K | 3200 K | M2 | 39.8 | 80.7 | 102.3 | MLESWT-A1-0000-0002E7 |
| | | | K3 | 35.2 | 71.4 | 90.5 | MLESWT-A1-0000-0001E7 |
| 80-CRI Warm White | 3700 K | 4300 K | M2 | 39.8 | 80.7 | 102.3 | MLESWT-H1-0000-0002E5 |
| | 2800 K | 3200 K | K3 | 35.2 | 71.4 | 90.5 | MLESWT-H1-0000-0001E7 |
| 85-CRI Warm White | 2800 K | 3200 K | K3 | 35.2 | 71.4 | 90.5 | MLESWT-P1-0000-0001E7 |
| 90-CRI Warm White | 2800 K | 3200 K | K2 | 30.6 | 62 | 78.6 | MLESWT-U1-0000-0000E7 |

Notes:

- Cree maintains a tolerance of $\pm 7\%$ on flux and power measurements, ± 0.005 on chromaticity (CCx, CCy) measurements and ± 2 on CRI measurements. See the Measurements section (page 22).
- Typical CRI for Cool White (4300 K – 8300 K CCT) is 75.
- Typical CRI for Warm White (2600 K – 4300 K CCT) is 80.
- Minimum CRI for 80-CRI White is 80.
- Minimum CRI for 85-CRI White is 85.
- Minimum CRI for 90-CRI White is 90
- * Calculated flux values are for reference only.

FLUX CHARACTERISTICS - PARALLEL COLOR ($T_j = 25\text{ }^\circ\text{C}$)

The following table provides several base order codes for XLamp ML-E color LEDs. It is important to note that the base order codes listed here are a subset of the total available order codes for the product family. For more order codes, as well as a complete description of the order-code nomenclature, please consult the XLamp ML LED Family Binning and Labeling document.

| Color | Dominant Wavelength Range | | | | Minimum Radiant Flux (mW) @ 150 mA | | Order Code |
|------------|---------------------------|----------|---------|----------|------------------------------------|-----------|-----------------------|
| | Minimum | | Maximum | | Group | Flux (mW) | |
| | Group | DWL (nm) | Group | DWL (nm) | | | |
| Royal Blue | D3 | 450 | D5 | 465 | 10 | 175 | MLEROY-A1-0000-000501 |

| Color | Dominant Wavelength Range | | | | Minimum Luminous Flux (lm) @ 150 mA | | Order Code |
|-------|---------------------------|----------|---------|----------|-------------------------------------|-----------|-----------------------|
| | Minimum | | Maximum | | Group | Flux (lm) | |
| | Group | DWL (nm) | Group | DWL (nm) | | | |
| Blue | B3 | 465 | B6 | 485 | G0 | 13.9 | MLEBLU-A1-0000-000U01 |
| | | | | | F0 | 10.7 | MLEBLU-A1-0000-000T01 |

| Color | Dominant Wavelength Range | | | | Minimum Luminous Flux (lm) @ 150 mA | | Order Code |
|-------|---------------------------|----------|---------|----------|-------------------------------------|-----------|-----------------------|
| | Minimum | | Maximum | | Group | Flux (lm) | |
| | Group | DWL (nm) | Group | DWL (nm) | | | |
| Green | G2 | 520 | G4 | 535 | K3 | 35.2 | MLEGRN-A1-0000-000101 |
| | | | | | K2 | 30.6 | MLEGRN-A1-0000-000001 |
| | | | | | J3 | 26.8 | MLEGRN-A1-0000-000X01 |

| Color | Dominant Wavelength Range | | | | Minimum Luminous Flux (lm) @ 150 mA | | Order Code |
|-------|---------------------------|----------|---------|----------|-------------------------------------|-----------|-----------------------|
| | Minimum | | Maximum | | Group | Flux (lm) | |
| | Group | DWL (nm) | Group | DWL (nm) | | | |
| Amber | A2 | 585 | A3 | 595 | J3 | 26.8 | MLEAMB-A1-0000-000X01 |
| | | | | | J2 | 23.5 | MLEAMB-A1-0000-000W01 |

| Color | Dominant Wavelength Range | | | | Minimum Luminous Flux (lm) @ 150 mA | | Order Code |
|-------|---------------------------|----------|---------|----------|-------------------------------------|-----------|-----------------------|
| | Minimum | | Maximum | | Group | Flux (lm) | |
| | Group | DWL (nm) | Group | DWL (nm) | | | |
| Red | R2 | 620 | R3 | 630 | J2 | 23.5 | MLERED-A1-0000-000W01 |
| | | | | | H0 | 18.1 | MLERED-A1-0000-000V01 |

- Note:
- Cree maintains a tolerance of $\pm 7\%$ on flux and power measurements, ± 0.005 on chromaticity (CCx, CCy) measurements and ± 2 on CRI measurements and ± 1 nm on dominant wavelength measurements. See the Measurements section (page 22).

FLUX CHARACTERISTICS - SERIES COLOR ($T_j = 25\text{ }^\circ\text{C}$)

The following table provides several base order codes for XLamp ML-E color LEDs. It is important to note that the base order codes listed here are a subset of the total available order codes for the product family. For more order codes, as well as a complete description of the order-code nomenclature, please consult the XLamp ML LED Family Binning and Labeling document.

| Color | Dominant Wavelength Range | | | | Minimum Luminous Flux (lm) @ 50 mA | | Order Code |
|-------|---------------------------|----------|---------|----------|------------------------------------|-----------|-----------------------|
| | Minimum | | Maximum | | Group | Flux (lm) | |
| | Group | DWL (nm) | Group | DWL (nm) | | | |
| Blue | B3 | 465 | B6 | 485 | G0 | 13.9 | MLESBL-A1-0000-000U01 |
| | | | | | F0 | 10.7 | MLESBL-A1-0000-000T01 |

| Color | Dominant Wavelength Range | | | | Minimum Luminous Flux (lm) @ 50 mA | | Order Code |
|-------|---------------------------|----------|---------|----------|------------------------------------|-----------|-----------------------|
| | Minimum | | Maximum | | Group | Flux (lm) | |
| | Group | DWL (nm) | Group | DWL (nm) | | | |
| Green | G2 | 520 | G4 | 535 | K3 | 35.2 | MLESGN-A1-0000-000101 |
| | | | | | K2 | 30.6 | MLESGN-A1-0000-000001 |
| | | | | | J3 | 26.8 | MLESGN-A1-0000-000X01 |

| Color | Dominant Wavelength Range | | | | Minimum Luminous Flux (lm) @ 37.5 mA | | Order Code |
|-------|---------------------------|----------|---------|----------|--------------------------------------|-----------|-----------------------|
| | Minimum | | Maximum | | Group | Flux (lm) | |
| | Group | DWL (nm) | Group | DWL (nm) | | | |
| Amber | A2 | 585 | A3 | 595 | J3 | 26.8 | MLESAM-A1-0000-000X01 |
| | | | | | J2 | 23.5 | MLESAM-A1-0000-000W01 |

| Color | Dominant Wavelength Range | | | | Minimum Luminous Flux (lm) @ 37.5 mA | | Order Code |
|-------|---------------------------|----------|---------|----------|--------------------------------------|-----------|-----------------------|
| | Minimum | | Maximum | | Group | Flux (lm) | |
| | Group | DWL (nm) | Group | DWL (nm) | | | |
| Red | R2 | 620 | R3 | 630 | J2 | 23.5 | MLESRD-A1-0000-000W01 |
| | | | | | H0 | 18.1 | MLESRD-A1-0000-000V01 |

- Note:
- Cree maintains a tolerance of $\pm 7\%$ on flux and power measurements, ± 0.005 on chromaticity (CCx, CCy) measurements and ± 2 on CRI measurements and ± 1 nm on dominant wavelength measurements. See the Measurements section (page 22).

RELATIVE SPECTRAL POWER DISTRIBUTION - WHITE

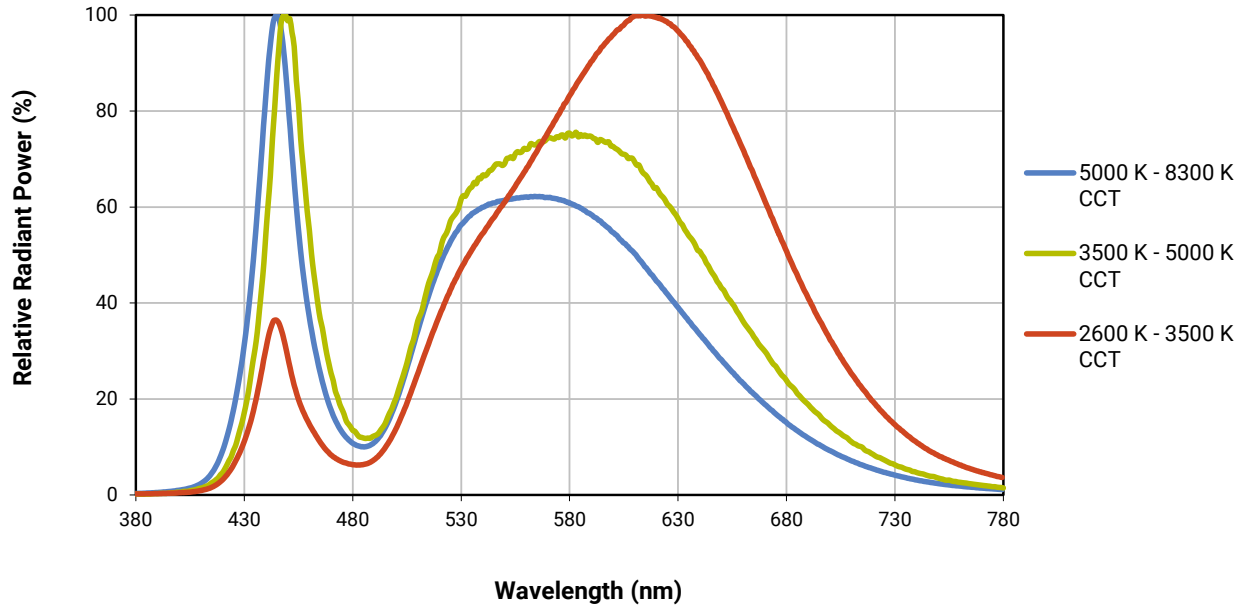

RELATIVE SPECTRAL POWER DISTRIBUTION - COLOR

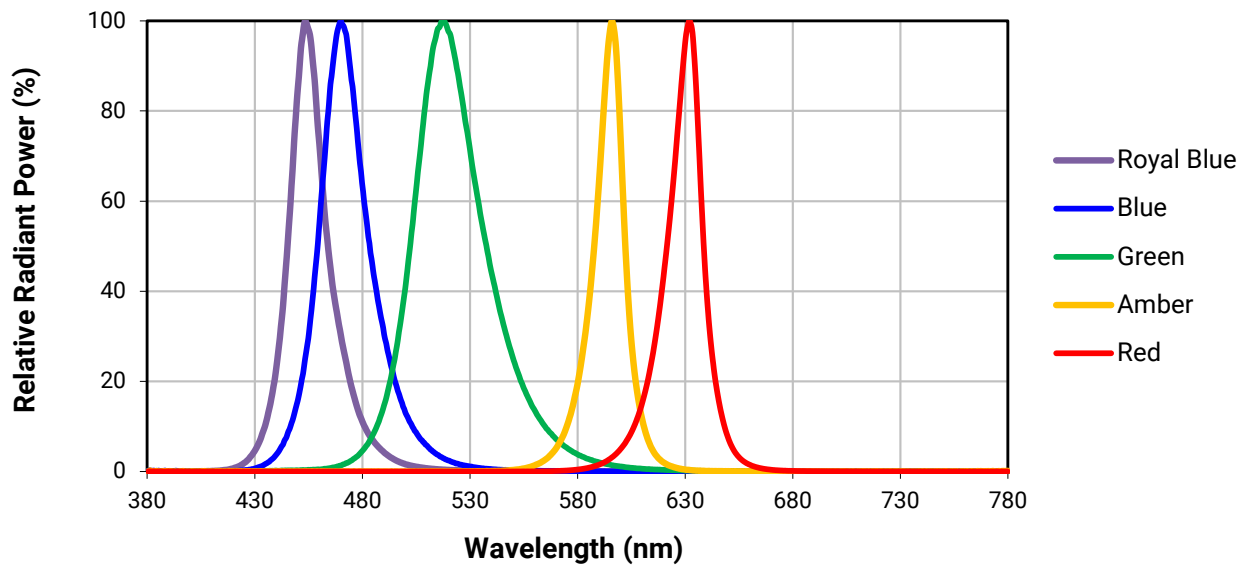

RELATIVE LUMINOUS FLUX VS. JUNCTION TEMPERATURE - WHITE (PARALLEL: $I_F = 150$ mA, SERIES: $I_F = 50$ mA)

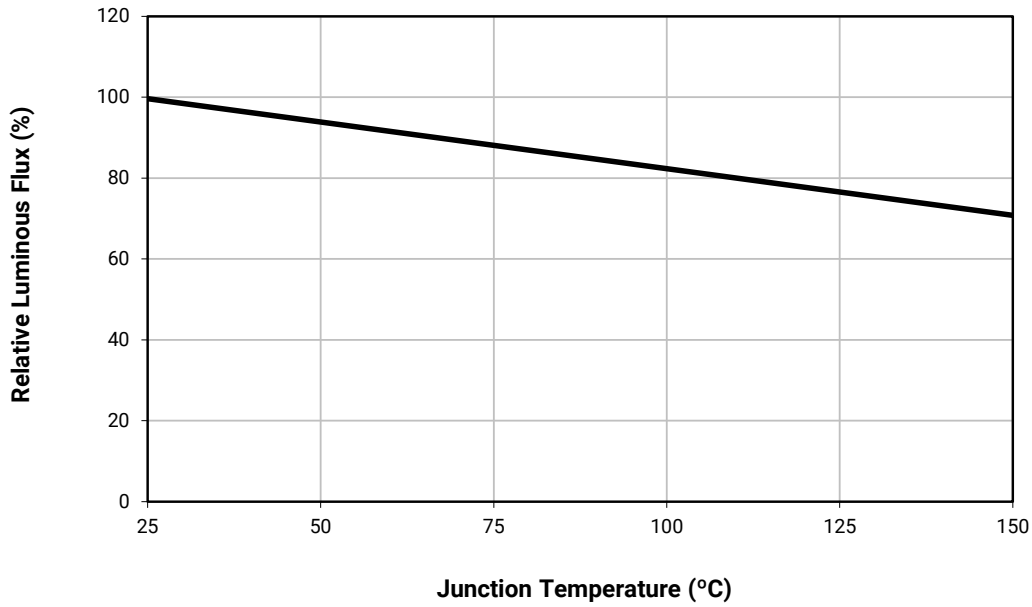

RELATIVE LUMINOUS FLUX VS. JUNCTION TEMPERATURE - PARALLEL: BLUE, GREEN, AMBER, RED ($I_F = 150$ mA), SERIES: BLUE, GREEN ($I_F = 50$ mA) AMBER, RED ($I_F = 37.5$ mA)

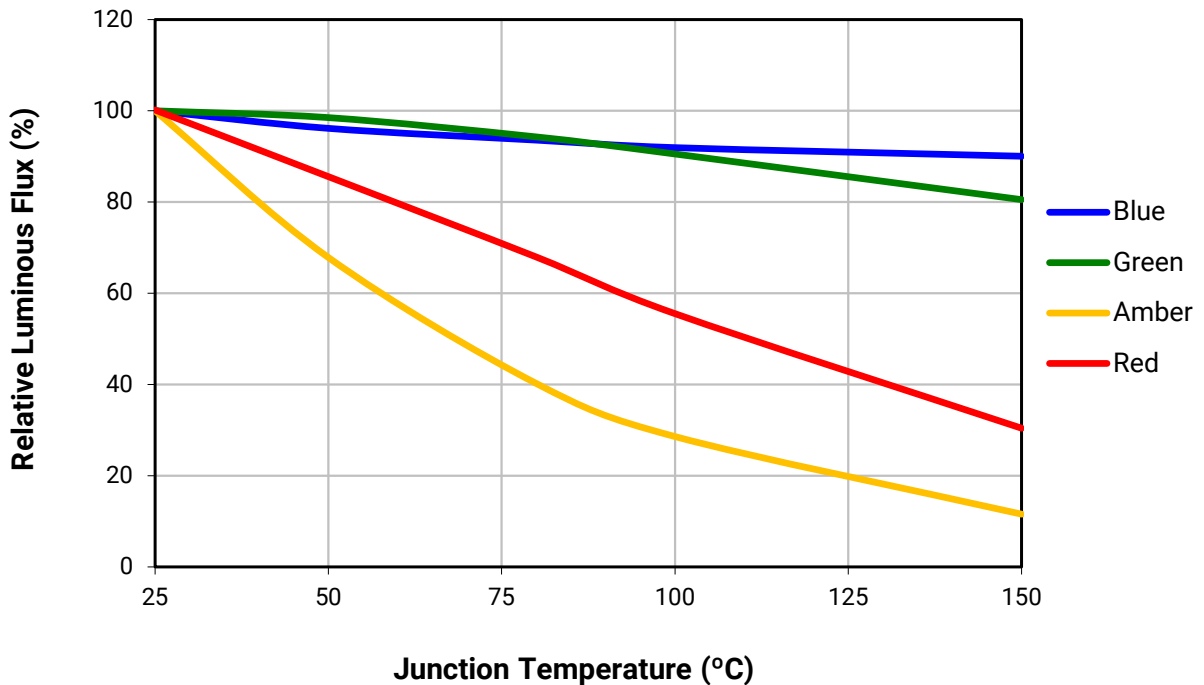

RELATIVE RADIANT FLUX VS. JUNCTION TEMPERATURE - PARALLEL ROYAL BLUE ($I_F = 150$ mA)

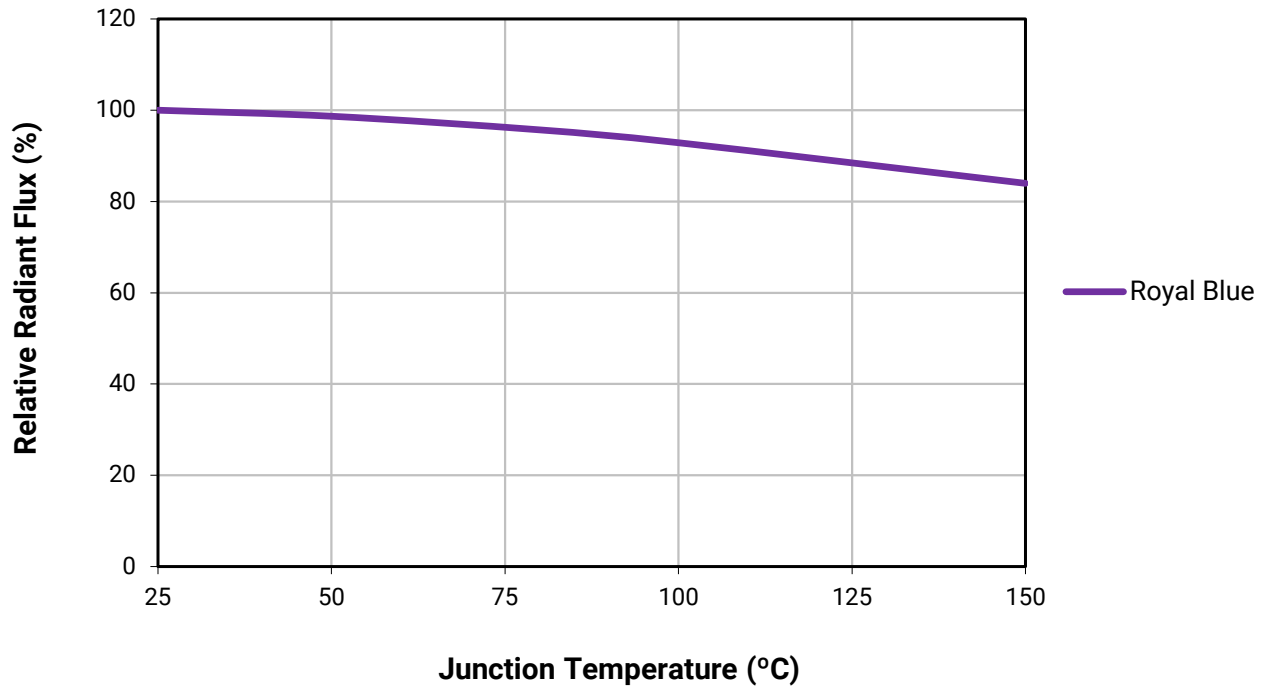

ELECTRICAL CHARACTERISTICS - PARALLEL WHITE ($T_j = 25\text{ }^\circ\text{C}$)

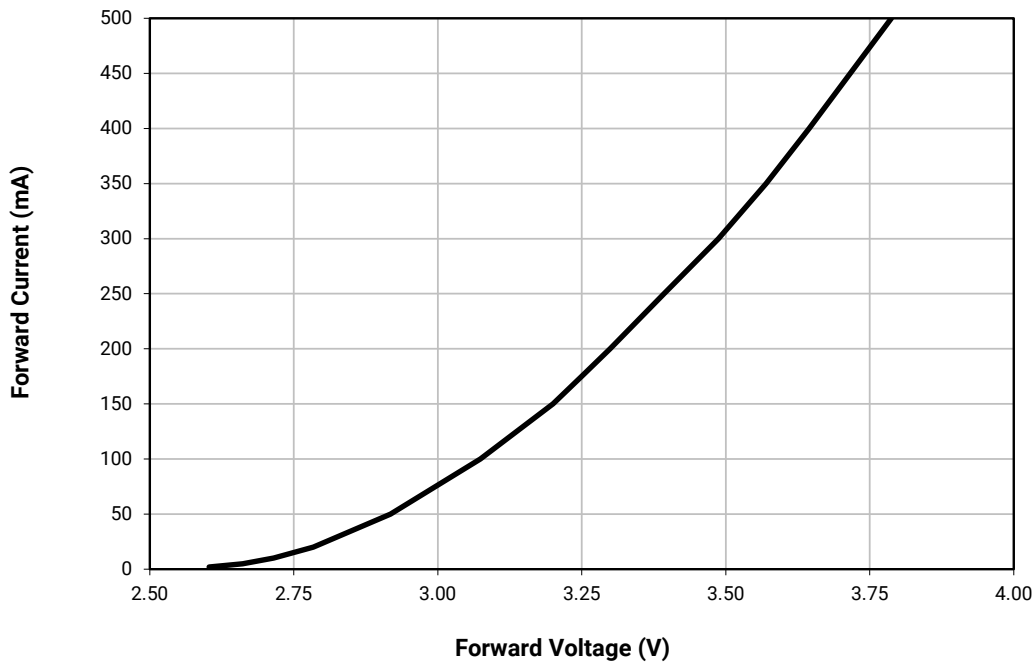

ELECTRICAL CHARACTERISTICS - SERIES WHITE ($T_j = 25\text{ }^\circ\text{C}$)

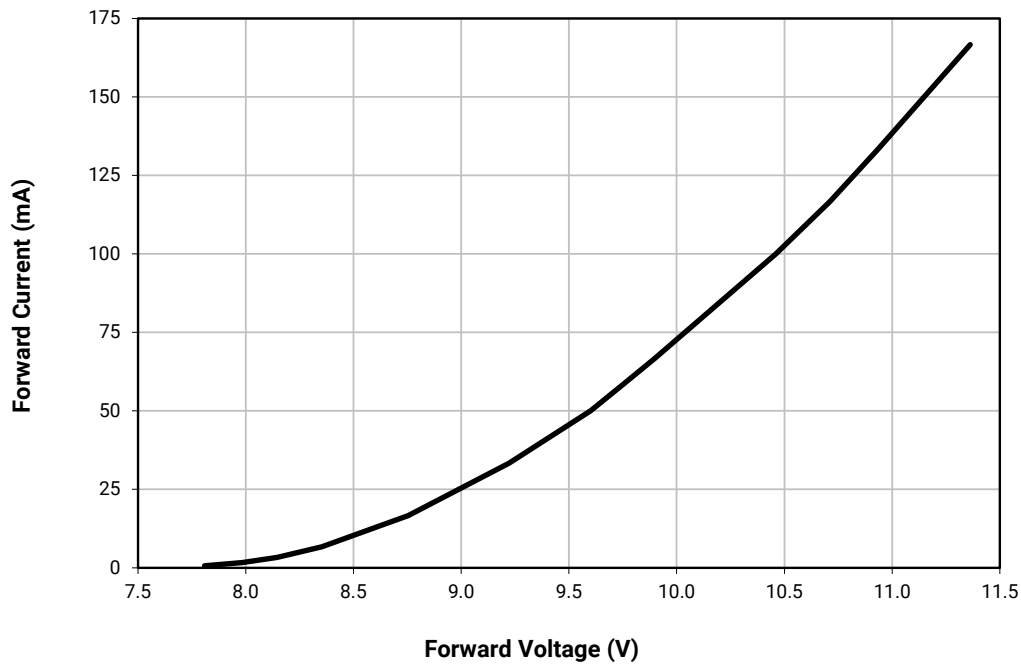

ELECTRICAL CHARACTERISTICS - PARALLEL COLOR ($T_j = 25\text{ }^\circ\text{C}$)

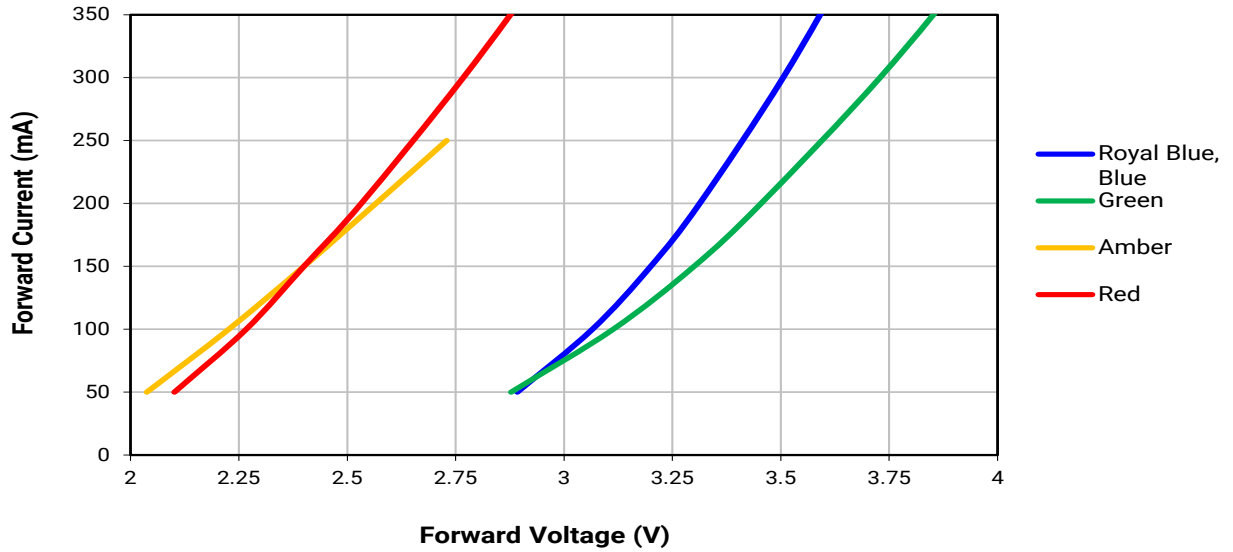

ELECTRICAL CHARACTERISTICS - SERIES COLOR ($T_j = 25\text{ }^\circ\text{C}$)

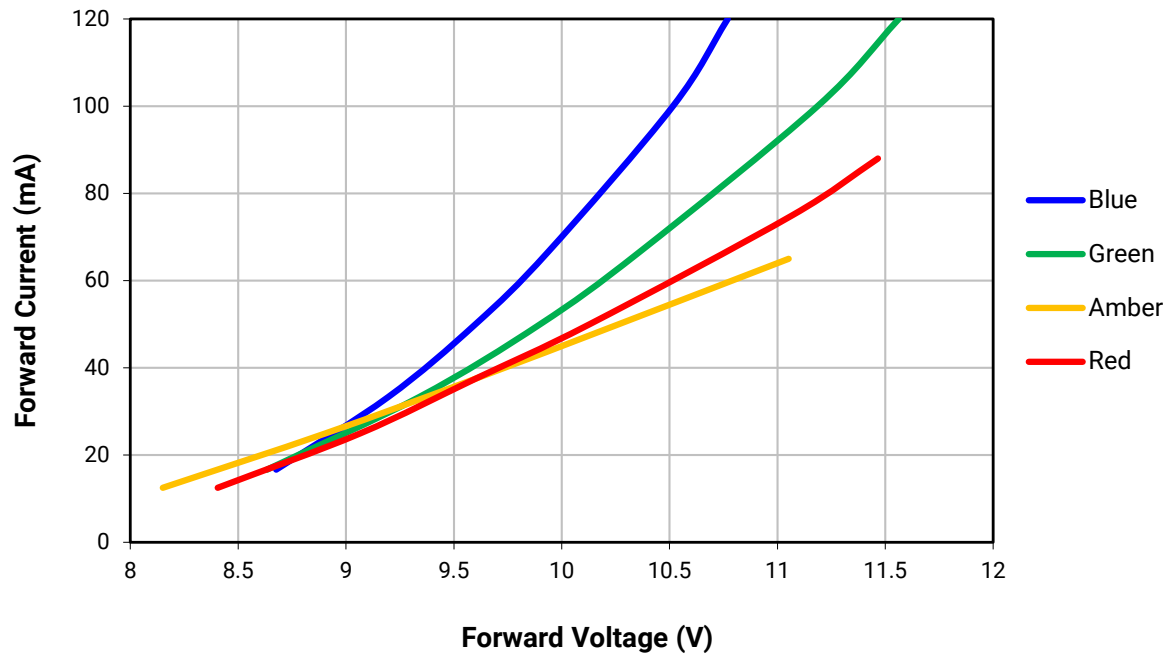

RELATIVE LUMINOUS FLUX VS. CURRENT - PARALLEL WHITE ($T_j = 25\text{ }^\circ\text{C}$)

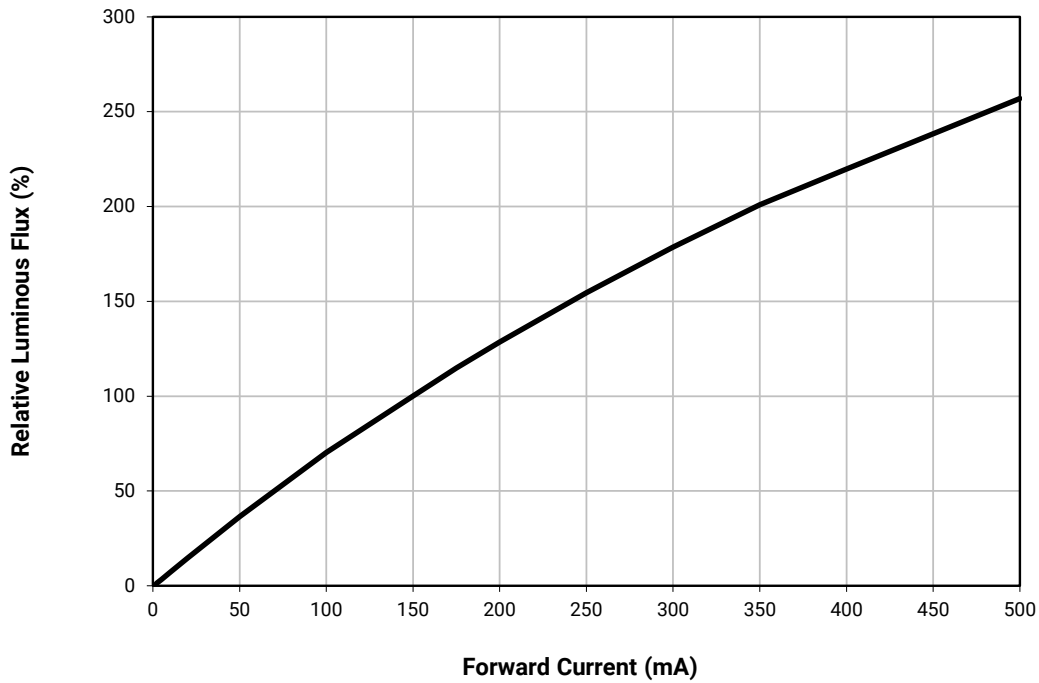

RELATIVE LUMINOUS FLUX VS. CURRENT - SERIES WHITE ($T_j = 25\text{ }^\circ\text{C}$)

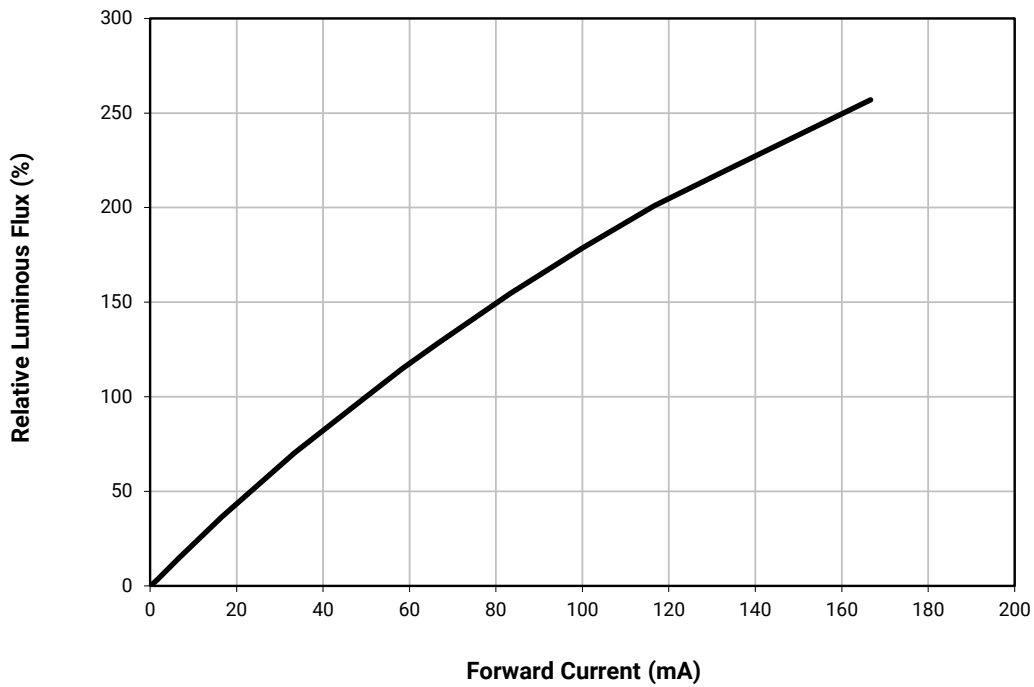

RELATIVE LUMINOUS FLUX VS. CURRENT - PARALLEL BLUE, GREEN, AMBER, RED ($T_j = 25\text{ }^\circ\text{C}$)

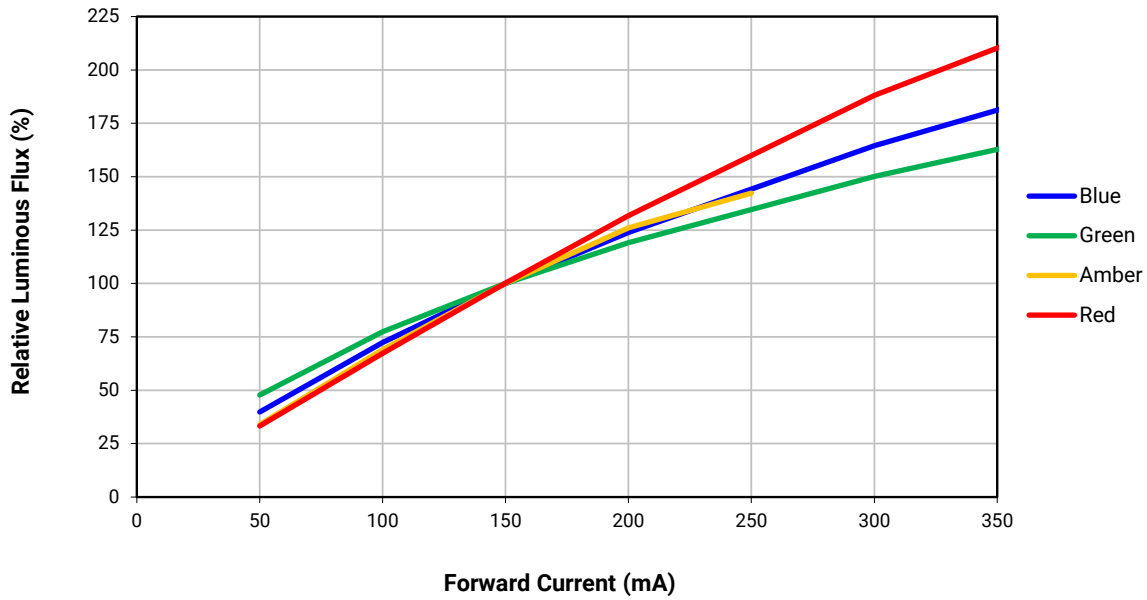

RELATIVE LUMINOUS FLUX VS. CURRENT - SERIES BLUE, GREEN, AMBER, RED ($T_j = 25\text{ }^\circ\text{C}$)

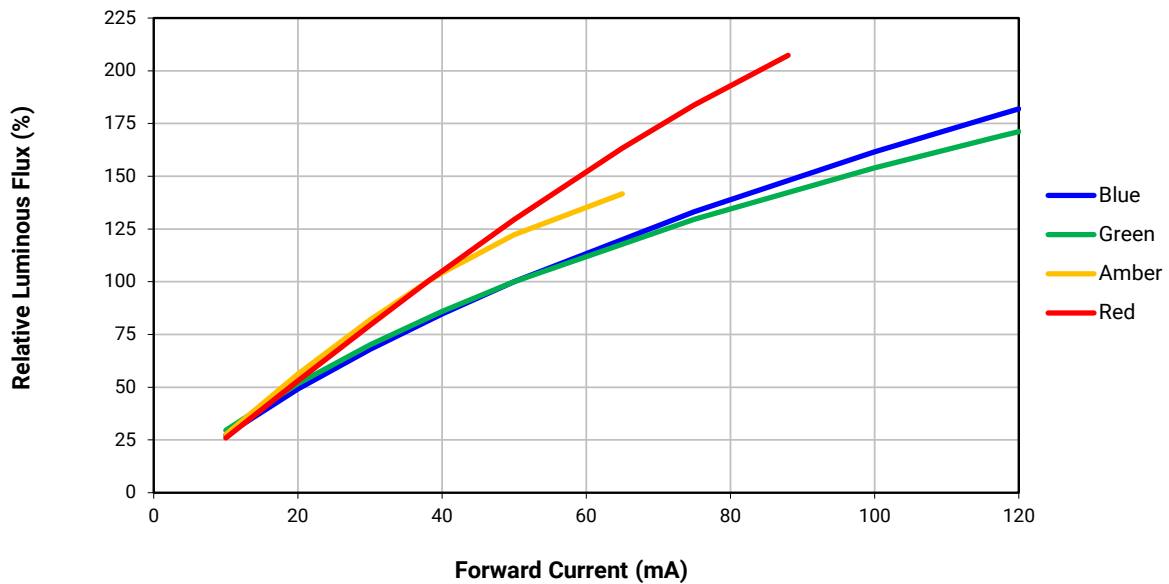

RELATIVE RADIANT FLUX VS. CURRENT - PARALLEL ROYAL BLUE ($T_j = 25\text{ }^\circ\text{C}$)

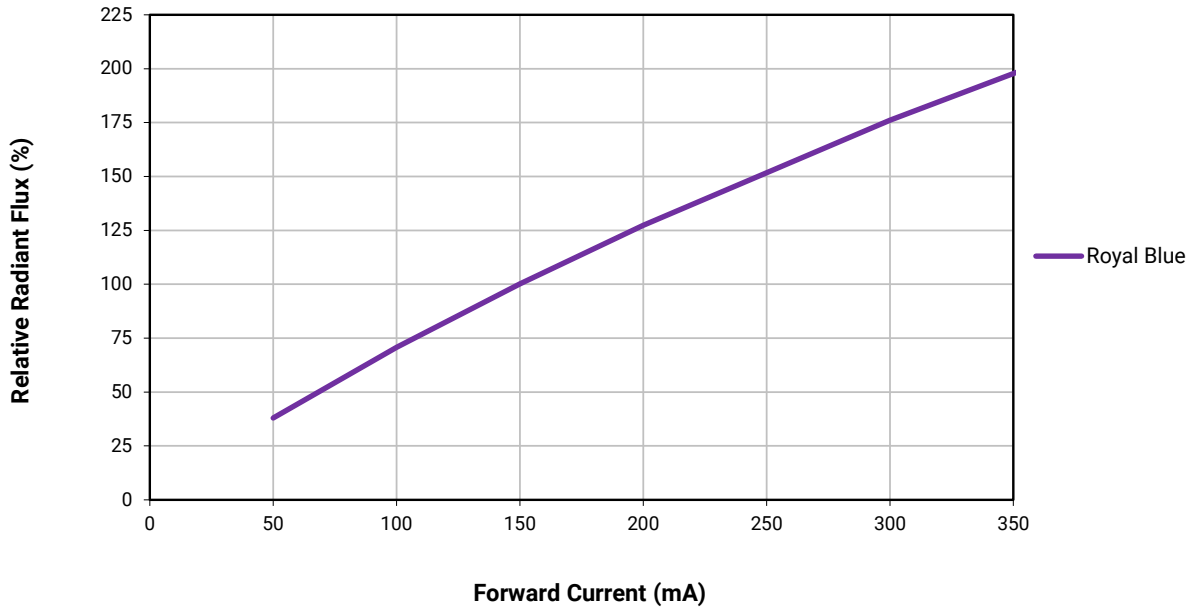

TYPICAL SPATIAL DISTRIBUTION - WHITE

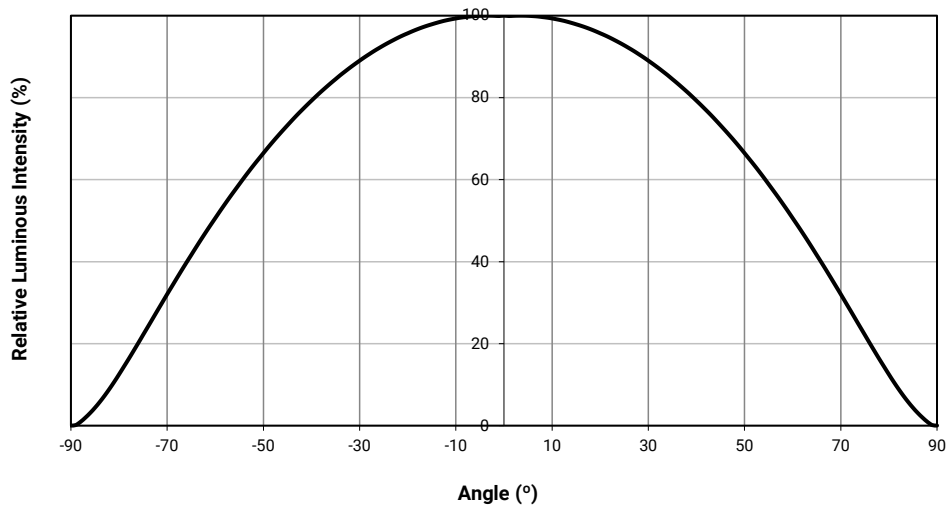

TYPICAL SPATIAL DISTRIBUTION - ROYAL BLUE, BLUE, GREEN

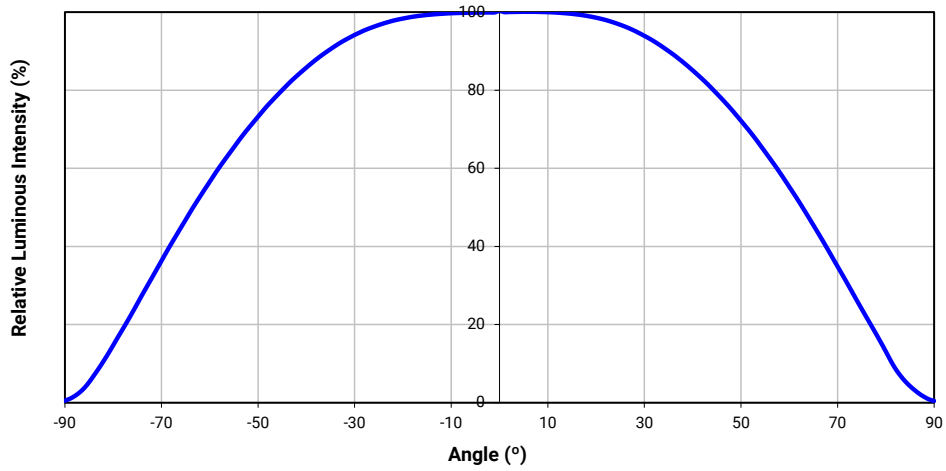

TYPICAL SPATIAL DISTRIBUTION - AMBER, RED

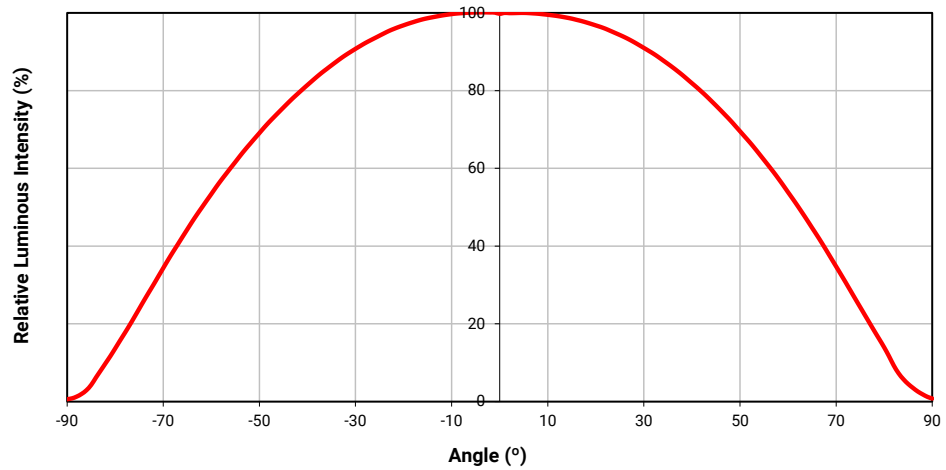

THERMAL DESIGN - PARALLEL WHITE

The maximum forward current is determined by the thermal resistance between the LED junction and ambient. It is crucial for the end product to be designed in a manner that minimizes the thermal resistance from the solder point to ambient in order to optimize lamp life and optical characteristics.

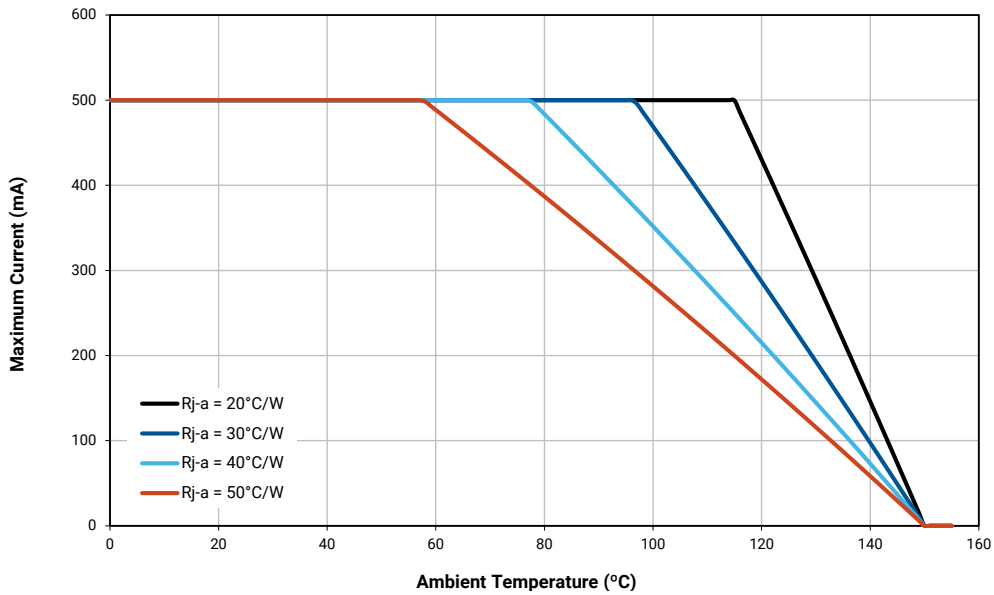

THERMAL DESIGN - SERIES WHITE

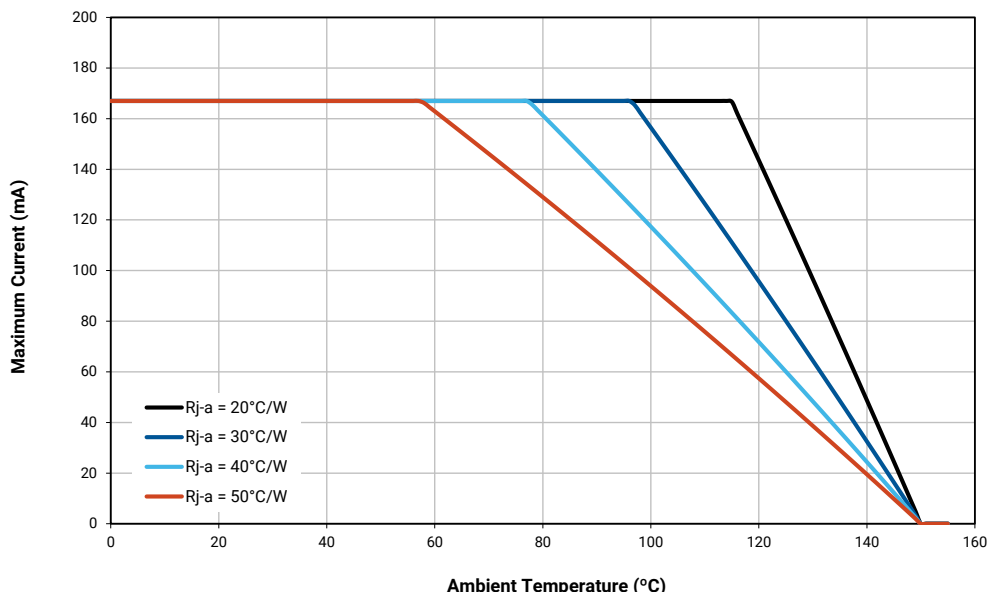

THERMAL DESIGN - PARALLEL ROYAL BLUE, BLUE

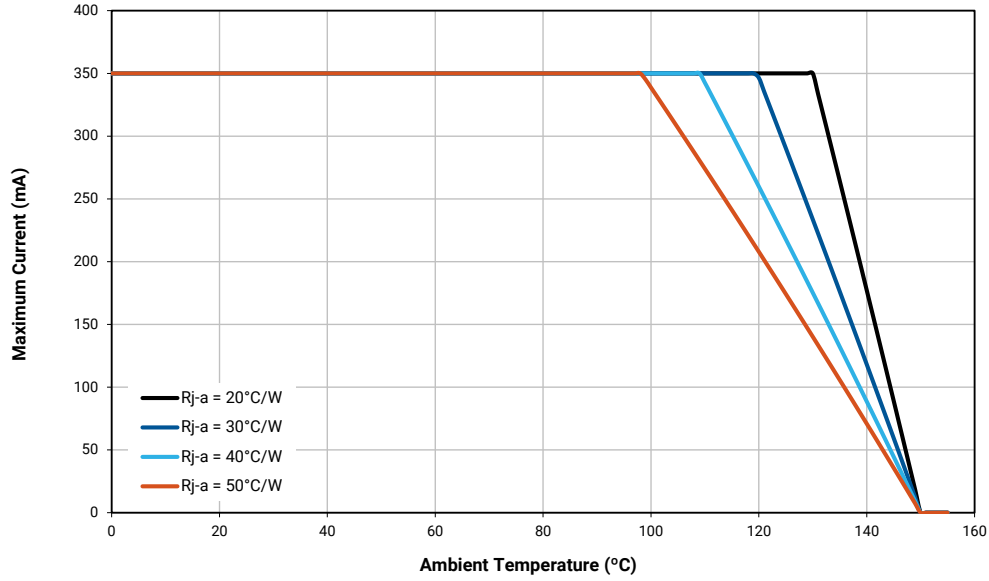

THERMAL DESIGN - SERIES BLUE

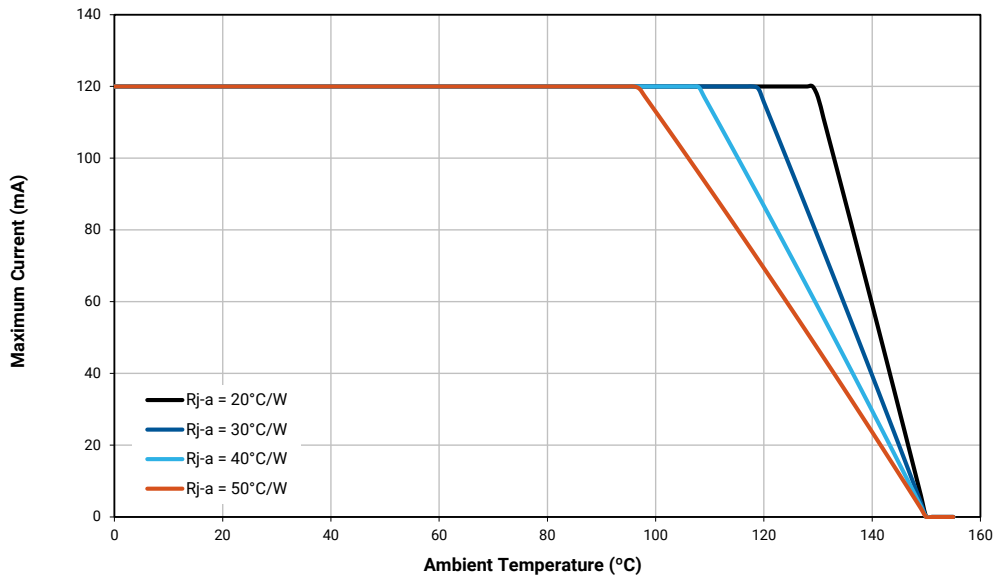

THERMAL DESIGN - PARALLEL GREEN

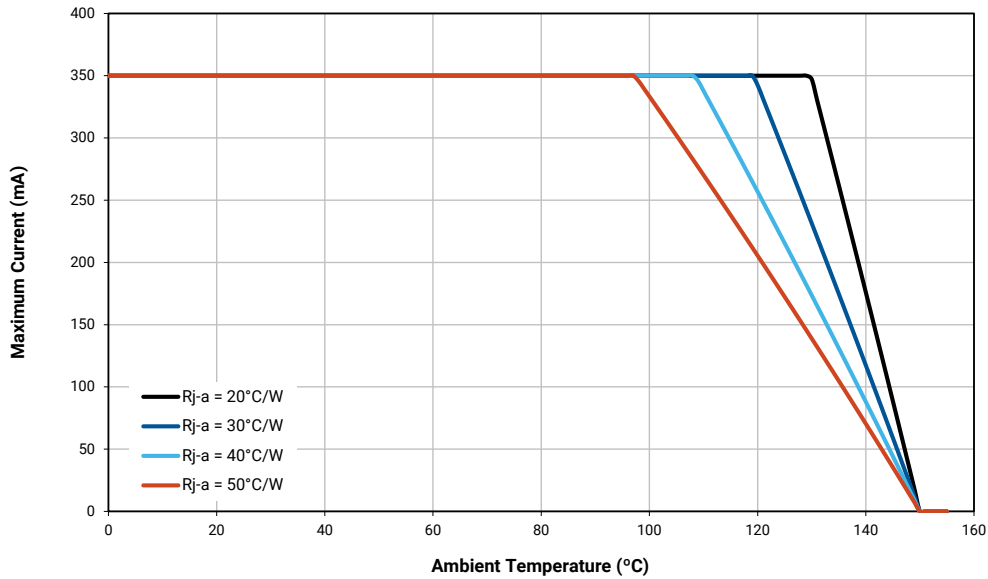

THERMAL DESIGN - SERIES GREEN

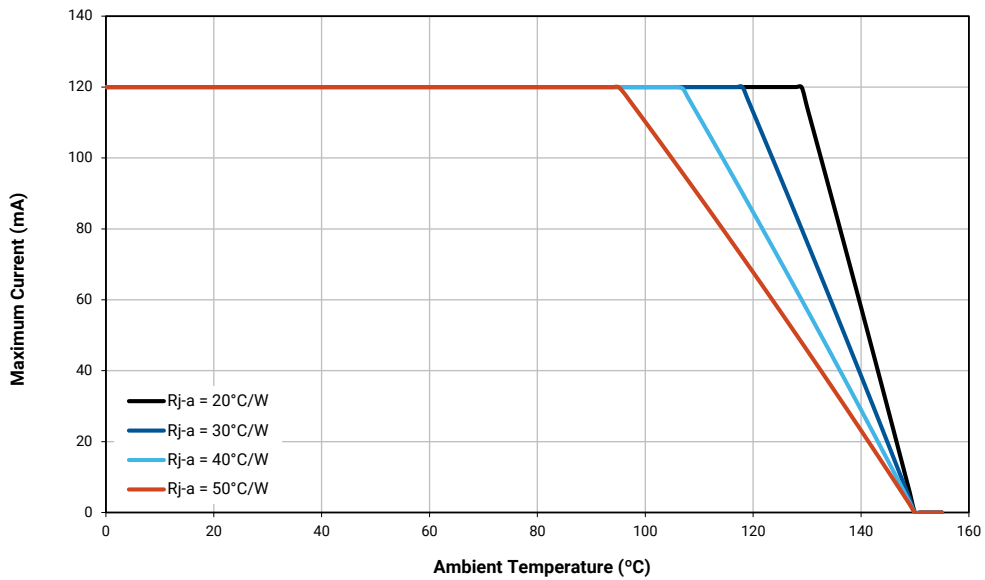

THERMAL DESIGN - PARALLEL AMBER

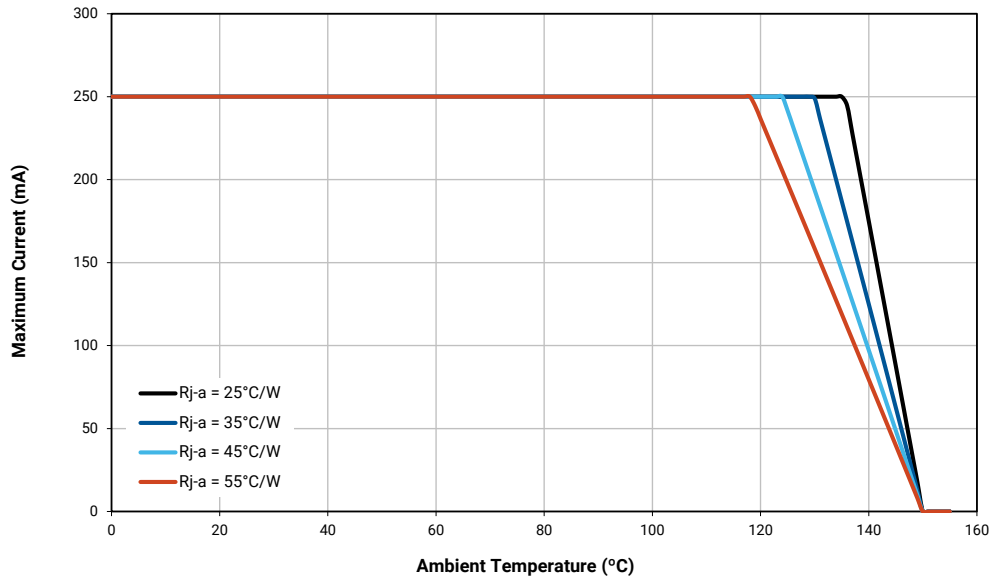

THERMAL DESIGN - SERIES AMBER

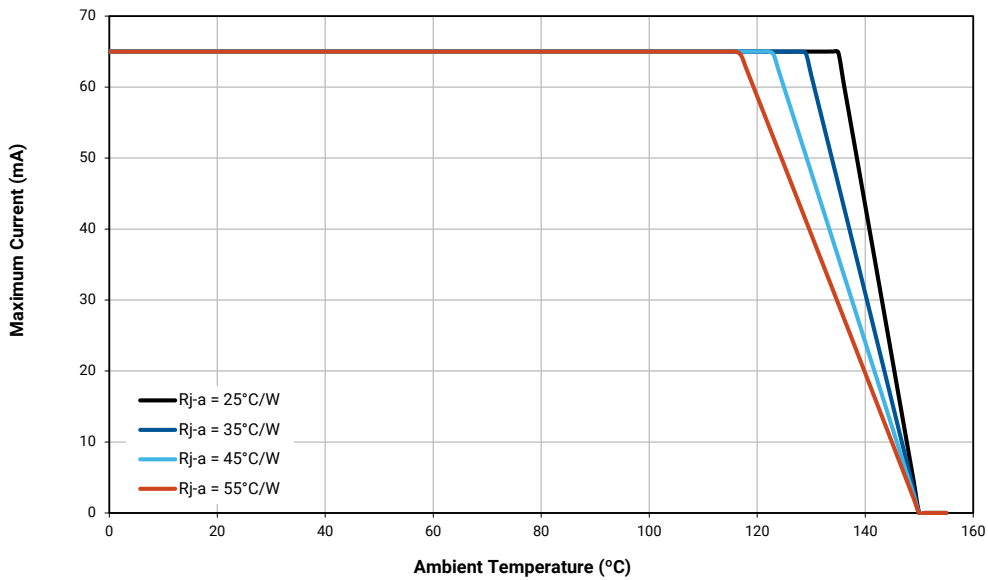

THERMAL DESIGN - PARALLEL RED

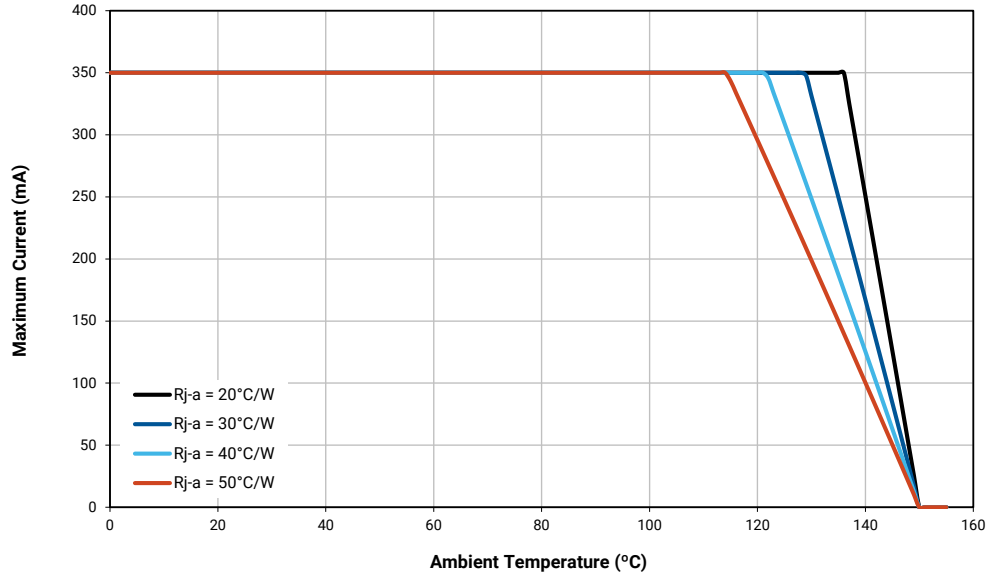

THERMAL DESIGN - SERIES RED

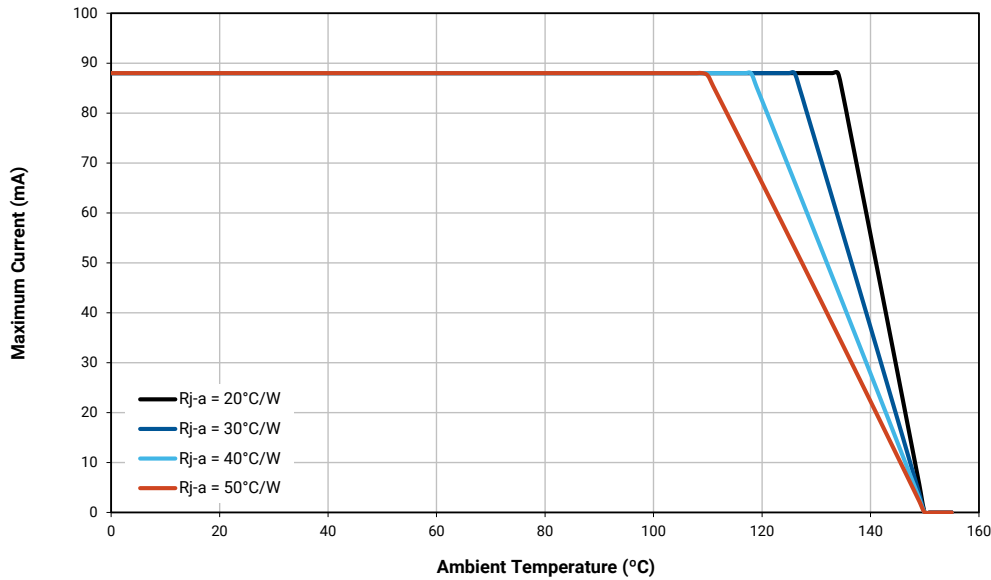

REFLOW SOLDERING CHARACTERISTICS

In testing, Cree has found XLamp ML-E LEDs to be compatible with JEDEC J-STD-020C, using the parameters listed below. As a general guideline, Cree recommends that users follow the recommended soldering profile provided by the manufacturer of the solder paste used.

Note that this general guideline may not apply to all PCB designs and configurations of reflow soldering equipment.



IPC/JEDEC J-STD-020C

| Profile Feature | Lead-Free Solder |
|---|------------------|
| Average Ramp-Up Rate ($T_{S_{max}}$ to T_P) | 1.2 °C/second |
| Preheat: Temperature Min ($T_{S_{min}}$) | 120 °C |
| Preheat: Temperature Max ($T_{S_{max}}$) | 170 °C |
| Preheat: Time ($t_{s_{min}}$ to $t_{s_{max}}$) | 65-150 seconds |
| Time Maintained Above: Temperature (T_L) | 217 °C |
| Time Maintained Above: Time (t_l) | 45-90 seconds |
| Peak/Classification Temperature (T_P) | 235 - 245 °C |
| Time Within 5 °C of Actual Peak Temperature (t_p) | 20-40 seconds |
| Ramp-Down Rate | 1 - 6 °C/second |
| Time 25 °C to Peak Temperature | 4 minutes max. |

Note: All temperatures refer to topside of the package, measured on the package body surface.

Note: While the high reflow temperatures (above) have been approved, Cree’s best practice guideline for reflow is to use as low a temperature as possible during the reflow soldering process for these LEDs.

NOTES

Measurements

The luminous flux, radiant power, chromaticity, forward voltage and CRI measurements in this document are binning specifications only and solely represent product measurements as of the date of shipment. These measurements will change over time based on a number of factors that are not within Cree’s control and are not intended or provided as operational specifications for the products. Calculated values are provided for informational purposes only and are not intended as specifications.

Pre-Release Qualification Testing

Please read the [LED Reliability Overview](#) for details of the qualification process Cree applies to ensure long-term reliability for XLamp LEDs and details of Cree’s pre-release qualification testing for XLamp LEDs.

Lumen Maintenance

Cree now uses standardized IES LM-80-08 and TM-21-11 methods for collecting long-term data and extrapolating LED lumen maintenance. For information on the specific LM-80 data sets available for this LED, refer to the public [LM-80 results document](#).

Please read the [Long-Term Lumen Maintenance application note](#) for more details on Cree’s lumen maintenance testing and forecasting. Please read the [Thermal Management application note](#) for details on how thermal design, ambient temperature, and drive current affect the LED junction temperature.

Moisture Sensitivity

Cree recommends keeping XLamp ML-E LEDs in the provided, resealable moisture-barrier packaging (MBP) until immediately prior to soldering. Unopened MBPs that contain XLamp LEDs do not need special storage for moisture sensitivity.

Once the MBP is opened, XLamp ML-E LEDs should be handled and stored as MSL 2a per JEDEC J-STD-033, meaning they have limited exposure time before damage to the LED may occur during the soldering operation. The table on the right specifies the maximum exposure time in days depending on temperature and humidity conditions. LEDs with exposure time longer than the specified maximums must be baked according to the baking conditions listed below.

| Temp. | Maximum Percent Relative Humidity | | | | | | |
|-------|-----------------------------------|-----|-----|-----|-----|-----|-----|
| | 30% | 40% | 50% | 60% | 70% | 80% | 90% |
| 35 °C | - | - | - | 17 | 1 | .5 | .5 |
| 30 °C | - | - | - | 28 | 1 | 1 | 1 |
| 25 °C | - | - | - | - | 2 | 1 | 1 |
| 20 °C | - | - | - | - | 2 | 1 | 1 |

Baking Conditions

It is not necessary to bake all XLamp ML-E LEDs. Only the LEDs that meet all of the following criteria must be baked:

1. LEDs that have been removed from the original MBP.
2. LEDs that have been exposed to a humid environment longer than listed in the Moisture Sensitivity section above.
3. LEDs that have not been soldered.

NOTES - CONTINUED

LEDs should be baked at 70 °C for 24 hours. LEDs may be baked on the original reels. Remove LEDs from the MBP before baking. Do not bake parts at temperatures higher than 70 °C. This baking operation resets the exposure time as defined in the Moisture Sensitivity section above.

Storage Conditions

XLamp ML-E LEDs that have been removed from the original MBP but not soldered should be stored in one of the following ways:

- Store the parts in a rigid metal container with a tight-fitting lid. Verify that the storage temperature is <30 °C, and place fresh desiccant and an RH indicator in the container to verify that the RH is no greater than 60%.
- Store the parts in a dry, nitrogen-purged cabinet or container that actively maintains the temperature at <30° and the RH at no greater than 60%.
- For short-term store only: LEDs can be resealed in the original MBP soon after opening. Fresh desiccant may be needed. Use the included humidity indicator card to verify <60% RH.

If an environment of <60% RH is not available for storage, XLamp ML-E LEDs should be baked (described above) before reflow soldering.

RoHS Compliance

The levels of RoHS restricted materials in this product are below the maximum concentration values (also referred to as the threshold limits) permitted for such substances, or are used in an exempted application, in accordance with EU Directive 2011/65/EC (RoHS2), as implemented January 2, 2013. RoHS Declarations for this product can be obtained from your Cree representative or from the Product Documentation sections of www.cree.com.

REACH Compliance

REACH substances of very high concern (SVHCs) information is available for this product. Since the European Chemical Agency (ECHA) has published notice of their intent to frequently revise the SVHC listing for the foreseeable future, please contact a Cree representative to insure you get the most up-to-date REACH SVHC Declaration. REACH banned substance information (REACH Article 67) is also available upon request.

UL® Recognized Component

Level 4 enclosure consideration. The LED package or a portion thereof has been investigated as a fire and electrical enclosure per ANSI/UL 8750.

Vision Advisory

WARNING: Do not look at an exposed lamp in operation. Eye injury can result. For more information about LEDs and eye safety, please refer to the [LED Eye Safety application note](#).

MECHANICAL DIMENSIONS (T_A = 25 °C)

All measurements are ±.13 mm unless otherwise indicated.

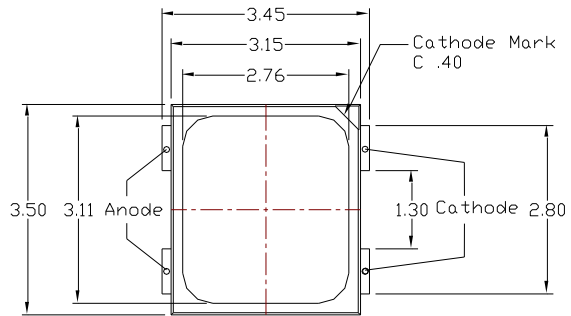
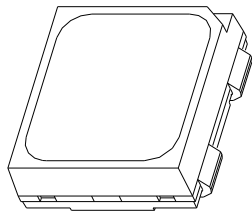

Top View

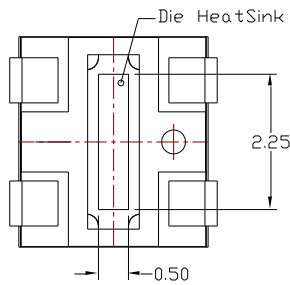

Bottom View

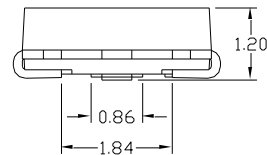

Side View

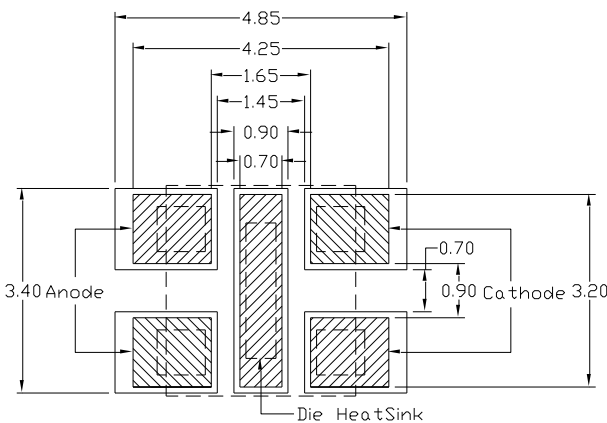

Recommended PCB Solder Pad

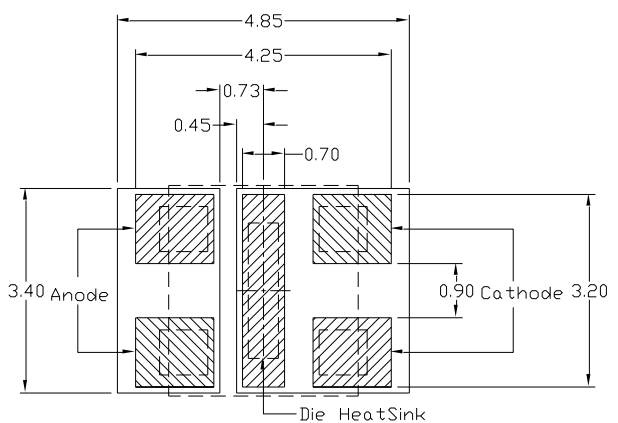

Alternate Solder Pad

MECHANICAL DIMENSIONS (T_A = 25 °C) - CONTINUED

All measurements are ±.13 mm unless otherwise indicated.

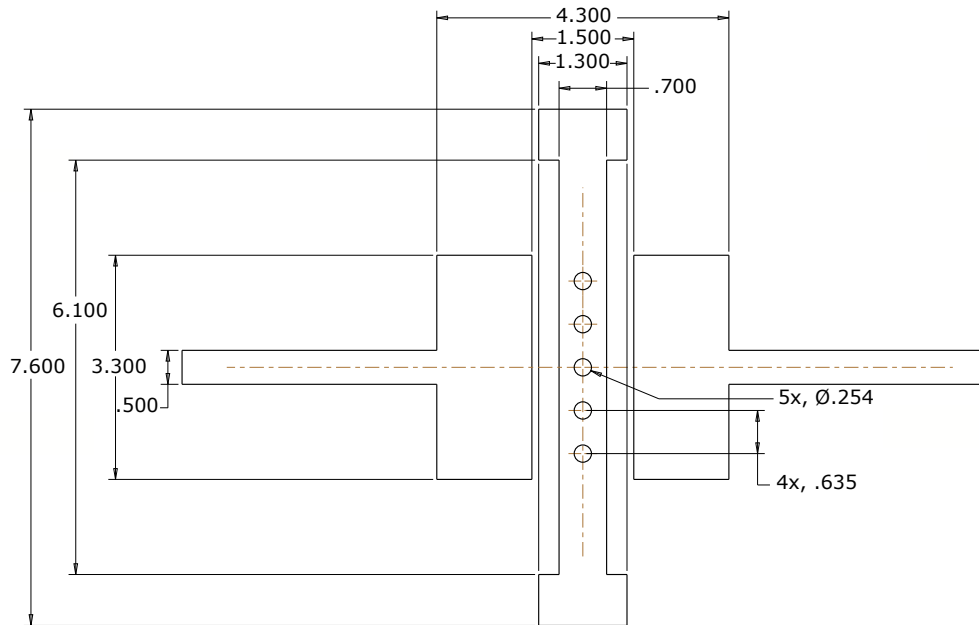

Recommended FR4 Solder Pad with Thermal Vias

TAPE AND REEL

All Cree carrier tapes conform to EIA-481D, Automated Component Handling Systems Standard.

Except as noted, all dimensions in mm.

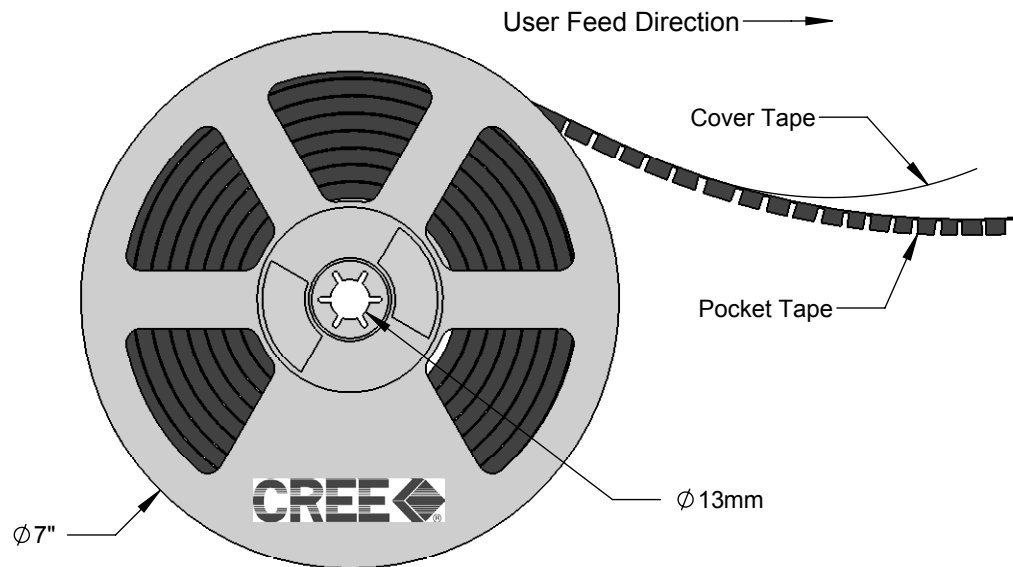
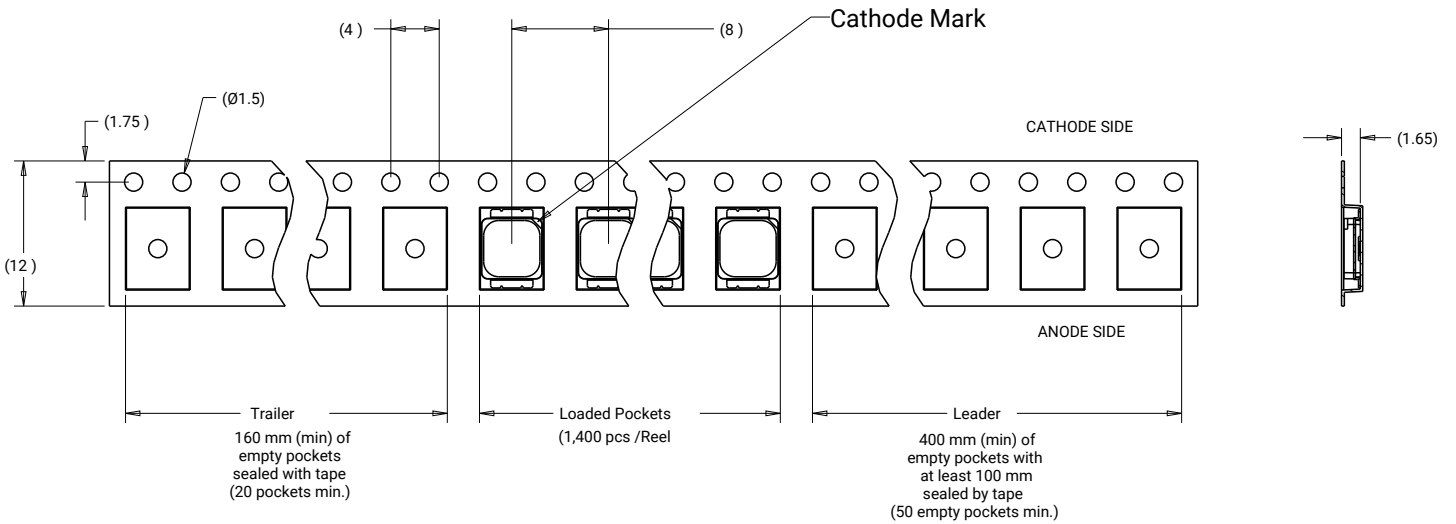

PACKAGING

Unpackaged Reel

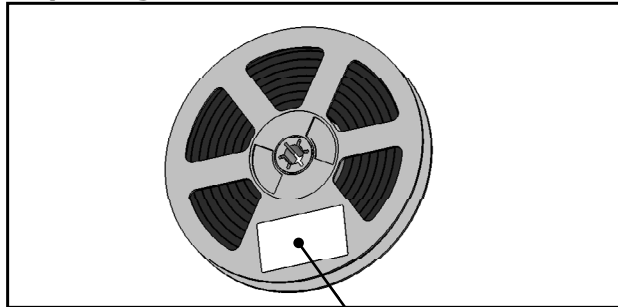

Label with Cree Bin Code, Quantity, Reel ID

Packaged Reel

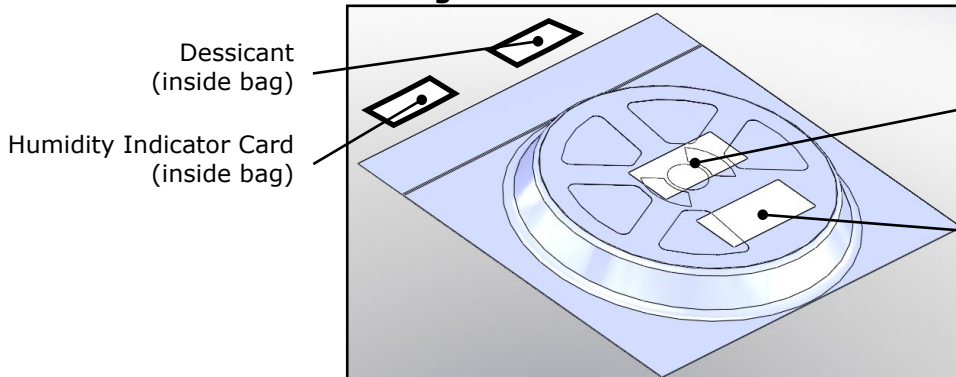

Dessicant (inside bag)

Humidity Indicator Card (inside bag)

Label with Cree Order Code, Quantity, Reel ID, PO #

Label with Cree Bin Code, Quantity, Reel ID

Boxed Reel

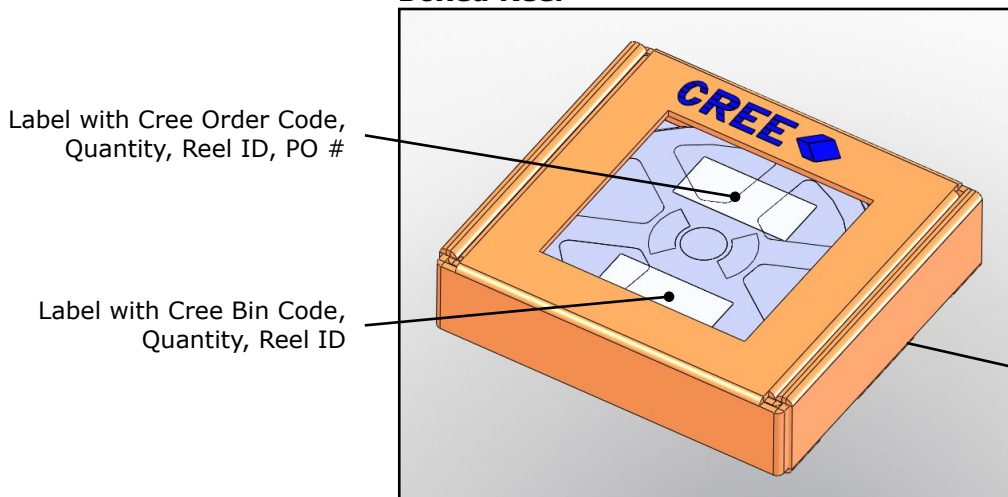

Label with Cree Order Code, Quantity, Reel ID, PO #

Label with Cree Bin Code, Quantity, Reel ID

Patent Label (on bottom of box)