

# Cree® P4 LED

## CP43B-RGS

## CP43B-AGS

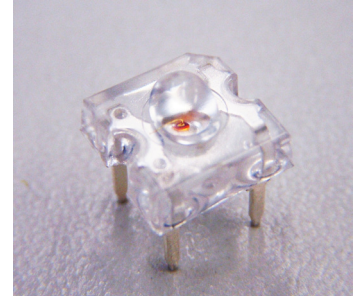

### PRODUCT DESCRIPTION

This revolutionary package design allows the lighting designer to reduce the number of LEDs required and provide a more uniform and unique illuminated appearance than with other LED solutions.

This is possible through the efficient optical-package design and high-current capabilities. The low-profile package can be easily coupled with reflectors or lenses to efficiently distribute light and provide the desired lit appearance. This product family employs green and blue LED materials, which allows designers to match the color of many lighting applications such as vehicle signal lamps and amusement lighting.

### FEATURES

- Size (mm): 7.6 x 7.6
- Color and Typical Dominant Wavelength:  
Red (624nm)  
Amber(591nm)
- Luminous Intensity (mcd)  
CP43B-RGS:(2130-8200)  
CP43B-AGS:(2130-8200)
- Lead - Free
- RoHS Compliant

### APPLICATIONS

- Channel Letter
- Amusement

### ABSOLUTE MAXIMUM RATINGS ( $T_A = 25^\circ\text{C}$ )

Items	Symbol	Absolute Maximum Rating	Unit
		Red/Amber	
Forward Current	$I_F$	70 <sup>Note1</sup>	mA
Peak Forward Current <sup>Note2</sup>	$I_{FP}$	200	mA
Reverse Voltage	$V_R$	5	V
Power Dissipation	$P_D$	210	mW
Operation Temperature	$T_{opr}$	-40 ~ +100	$^\circ\text{C}$
Storage Temperature	$T_{stg}$	-40 ~ +100	$^\circ\text{C}$
Lead Soldering Temperature	$T_{sol}$	Max. 260 $^\circ\text{C}$ for 5 sec. max. (3 mm from the base of the epoxy bulb)	
Electrostatic Discharge Classification (MIL-STD-883E)	ESD	Class 2	

**Note:**

1. A heat sink is recommended if the device is operated at ambient temperatures higher than 25 $^\circ\text{C}$ .
2. Pulse width  $\leq 0.1$  msec, duty  $\leq 1/10$ .

### TYPICAL ELECTRICAL & OPTICAL CHARACTERISTICS ( $T_A = 25^\circ\text{C}$ )

Characteristics	Color	Symbol	Condition	Unit	Minimum	Typical	Maximum
Forward Voltage	Red/Amber	$V_F$	$I_F = 70$ mA	V		2.5	3.0
Reverse Current	Red/Amber	$I_R$	$V_R = 5$ V	$\mu\text{A}$			100
Dominant Wavelength	Red	$\lambda_D$	$I_F = 70$ mA	nm	618	624	630
	Amber	$\lambda_D$	$I_F = 70$ mA	nm	584	591	599
Luminous Intensity	Red	$I_V$	$I_F = 70$ mA	mcd	2130	4500	
	Amber	$I_V$	$I_F = 70$ mA	mcd	2130	5000	
50% Power Angle	Red/Amber	$2\theta_{1/2H-H}$	$I_F = 70$ mA	deg		90	
	Red/Amber	$2\theta_{1/2V-V}$	$I_F = 70$ mA	deg		35	

## INTENSITY BIN LIMIT ( $I_F = 70 \text{ mA}$ )

Red

Bin Code	Min.(mcd)	Max.(mcd)
V0	2130	3000
W0	3000	4180
X0	4180	5860
Y0	5860	8200

Amber

Bin Code	Min.(mcd)	Max.(mcd)
V0	2130	3000
W0	3000	4180
X0	4180	5860
Y0	5860	8200

- Tolerance of measurement of luminous intensity is  $\pm 15\%$

## COLOR BIN LIMIT ( $I_F = 70 \text{ mA}$ )

Red

Bin Code	Min.(nm)	Max.(nm)
RA	618	630

Amber

Bin Code	Min.(nm)	Max.(nm)
A2	584	587
A3	587	590
A4	590	593
A5	593	596
A6	596	599

- Tolerance of measurement of dominant wavelength is  $\pm 1 \text{ nm}$

## VF BIN LIMIT ( $I_F = 70 \text{ mA}$ )

Red

Bin Code	Min. (V)	Max. (V)
23	2.0	2.2
24	2.2	2.4
25	2.4	2.6
26	2.6	2.8
27	2.8	3.0

Amber

Bin Code	Min. (V)	Max. (V)
23	2.0	2.2
24	2.2	2.4
25	2.4	2.6
26	2.6	2.8
27	2.8	3.0

- Tolerance of measurement of VF is  $\pm 0.05\text{V}$ .

### ORDER CODE TABLE\*

Color	Kit Number	Viewing Angle	Luminous Intensity (mcd)		Dominant Wavelength			
			Min.	Max.	Color Bin	Min. (nm)	Color Bin	Max. (nm)
Red	CP43B-RGS-CV0Y0AA4	90	2130	8200	RA	618	RA	630
Red	CP43B-RGS-CW0Y0AA4	90	3000	8200	RA	618	RA	630
Red	CP43B-RGS-CX0Y0AA4	90	4180	8200	RA	618	RA	630

Color	Kit Number	Viewing Angle	Luminous Intensity (mcd)		Dominant Wavelength			
			Min.	Max.	Color Bin	Min. (nm)	Color Bin	Max. (nm)
Amber	CP43B-AGS-CV0Y0264	90	2130	8200	A2	584	A6	599
Amber	CP43B-AGS-CW0Y0354	90	3000	8200	A3	587	A5	596
Amber	CP43B-AGS-CX0Y0354	90	4180	8200	A3	587	A5	596

Notes:

1. The above kit numbers represent order codes which include multiple flux-bin and color-bin codes. Only one flux-bin code and one color-bin code will be shipped on each reel. And single flux-bin code, single color bin-codes will not be orderable.
2. Please refer to the "Cree LED Lamp Reliability Test Standards" document for reliability test conditions.
3. Please refer to the "Cree LED Lamp Soldering & Handling" document for information about how to use this LED product safely.

## GRAPHS

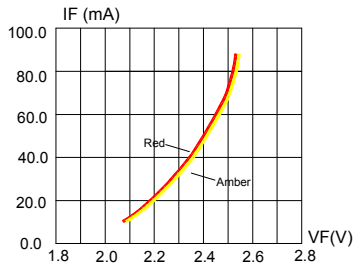

FIG.1 FORWARD CURRENT VS. FORWARD VOLTAGE.

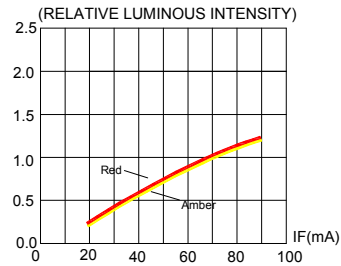

FIG.2 RELATIVE LUMINOUS INTENSITY VS. FORWARD CURRENT

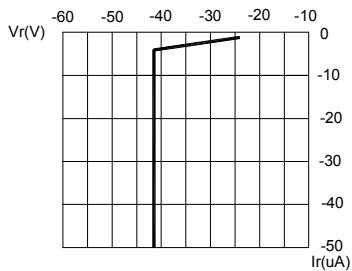

FIG.3 Red & Amber REVERSE CURRENT VS. REVERSE VOLTAGE.

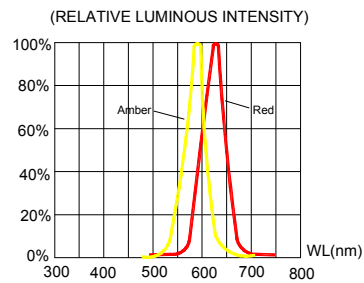

FIG.4 RELATIVE LUMINOUS INTENSITY VS. WAVELENGTH.

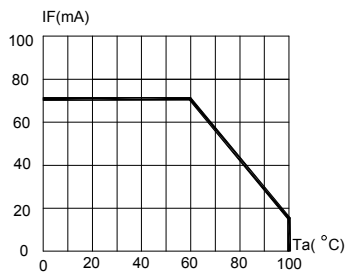

FIG.5 Red & Amber MAXIMUM FORWARD DC CURRENT VS AMBIENT TEMPERATURE ( $T_{jmax}=120^{\circ}C$ )

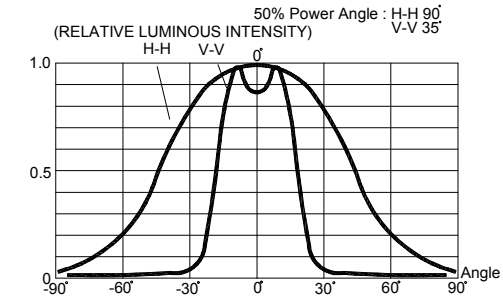

FIG.6 FAR FIELD PATTERN

The above data are collected from statistical figures that do not necessarily correspond to the actual parameters of each single LED. Hence, these data will be changed without further notice.

## MECHANICAL DIMENSIONS

All dimensions are in mm. Tolerance is  $\pm 0.25$  mm unless otherwise noted.

An epoxy meniscus extend about 1.5 mm down the leads.

All metal burr dimension is 0.2 mm max.

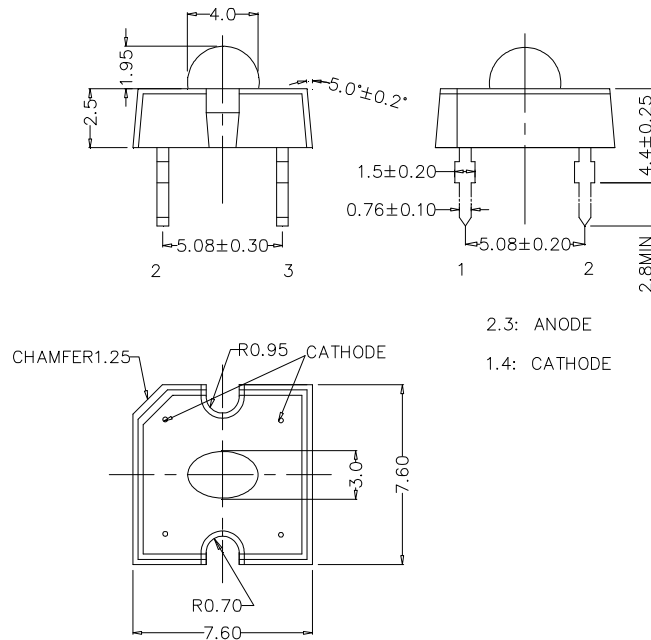

## NOTES

### RoHS Compliance

The levels of environmentally sensitive, persistent biologically toxic (PBT), persistent organic pollutants (POP), or otherwise restricted materials in this product are below the maximum concentration values (also referred to as the threshold limits) permitted for such substances, or are used in an exempted application, in accordance with EU Directive 2002/95/EC on the restriction of the use of certain hazardous substances in electrical and electronic equipment (RoHS), as amended through April 21, 2006.

### Vision Advisory Claim

Users should be cautioned not to stare at the light of this LED product. The bright light can damage the eye.

## KIT NUMBER SYSTEM

All dimensions in mm. Cree LED lamps are tested and sorted into performance bins. A bin is specified by ranges of color, forward voltage, and brightness. Sorted LEDs are packaged for shipping in various convenient options. Please refer to the "Cree LED Lamp Packaging Standard" document for more information about shipping and packaging options.

Cree LEDs are sold by order codes in combinations of bins called kits. Order codes are configured in the following manner:



## PACKAGING

### Features:

- The LEDs are packed in cardboard boxes after packaging in normal or anti-electrostatic bags.
- Cardboard boxes will be used to protect the LEDs from mechanical shock during transportation.
- The boxes are not water resistant, and they must be kept away from water and moisture.
- The Tube Pack type of packaging.
- Max 60 pcs per tube.

