

## Cree® XLamp® XQ-E LEDs



**XQ-E High Density LEDs**



**XQ-E High Intensity LEDs**

### PRODUCT DESCRIPTION

The XLamp® XQ-E LEDs are available in two versions: high density and high intensity. The XQ-E High Density LED enables lighting manufacturers to significantly reduce the size and total cost of their LED luminaires versus similar performance 3.5-mm footprint LEDs, without sacrificing lumen output, efficacy or reliability. The XQ-E's combination of optical symmetry, consistent design across all configurations and tiny 1.6 mm X 1.6 mm footprint simplifies manufacturing and design while providing excellent color mixing.

The new XQ-E High Intensity LED uses an innovative primary optic design optimized to deliver maximum candela, especially through narrow-beam secondary optics.

### FEATURES

- Cree's smallest lighting class LED: 1.6 mm X 1.6 mm
- Available in high-density & high-intensity versions for design flexibility
- Available in 70, 80, & 90 CRI white, royal blue, blue, green, PC amber, red-orange, red & high efficiency (HE) photo red
- Maximum drive current: 1 A (high density & high intensity)
- Reflow solderable - JEDEC J-STD-020C compatible
- Unlimited floor life at ≤ 30 °C/85% RH
- RoHS and REACH compliant
- UL® recognized component (E349212)

### TABLE OF CONTENTS

Characteristics .....	2
Flux Characteristics - High Density White ..	3
Flux Characteristics - High Density Color..	4
Flux Characteristics - High Intensity White .....	6
Flux Characteristics - High Intensity Color.....	7
Relative Spectral Power Distribution .....	9
Relative Flux vs. Junction Temperature..	11
Electrical Characteristics.....	14
Relative Flux vs. Current .....	16
Typical Spatial Distribution.....	19
Thermal Design .....	21
Reflow Soldering Characteristics.....	23
Notes .....	24
Mechanical Dimensions .....	26
Tape and Reel.....	28
Packaging.....	30



## CHARACTERISTICS

Characteristics	Unit	Minimum	Typical	Maximum
Thermal resistance, junction to solder point - white, royal blue, blue	°C/W		6	
Thermal resistance, junction to solder point - green	°C/W		9	
Thermal resistance, junction to solder point - PC amber	°C/W		8	
Thermal resistance, junction to solder point - red-orange, red, HE photo red	°C/W		5	
Viewing angle (FWHM) - High Density white	degrees		110	
Viewing angle (FWHM) - High Density royal blue, blue, green, PC amber	degrees		125	
Viewing angle (FWHM) - High Density red-orange, red, HE photo red	degrees		130	
Viewing angle (FWHM) - High Intensity white	degrees		120	
Viewing angle (FWHM) - High Intensity royal blue, blue, green	degrees		130	
Viewing angle (FWHM) - High Intensity PC amber	degrees		120	
Viewing angle (FWHM) - High Intensity red-orange, red	degrees		125	
Temperature coefficient of voltage - white	mV/°C		-2.3	
Temperature coefficient of voltage - royal blue, blue	mV/°C		-3.3	
Temperature coefficient of voltage - green	mV/°C		-3.8	
Temperature coefficient of voltage - PC amber	mV/°C		-3.3	
Temperature coefficient of voltage - red-orange, red	mV/°C		-1.8	
Temperature coefficient of voltage - HE photo red	mV/°C		-1.6	
ESD withstand voltage (HBM per Mil-Std-883D)- High Density	V			8000
ESD classification (HBM per Mil-Std-883D) - High Intensity			Class 3A	
DC forward current	mA			1000
Reverse voltage	V			5
Forward voltage (@ 350 mA, 85 °C) - white	V		2.9	3.25
Forward voltage (@ 350 mA, 25 °C) - royal blue, blue	V		3.1	3.5
Forward voltage (@ 350 mA, 25 °C) - green	V		3.2	3.6
Forward voltage (@ 350 mA, 25 °C) - PC amber	V		3.1	3.5
Forward voltage (@ 350 mA, 25 °C) - red-orange, red	V		2.2	2.6
Forward voltage (@ 350 mA, 25 °C) - HE photo red	V		2.1	2.4
LED junction temperature	°C			150

## FLUX CHARACTERISTICS - HIGH DENSITY WHITE ( $T_J = 85\text{ }^\circ\text{C}$ )

The following table provides several base order codes for XLamp XQ-E High Density white LEDs. It is important to note that the base order codes listed here are a subset of the total available order codes for the product family. For more order codes, as well as a complete description of the order-code nomenclature, please consult the XLamp XQ Family LEDs Binning and Labeling document.

Color	CCT Range		Minimum Luminous Flux (lm) @ 350 mA			Calculated Minimum Luminous Flux (lm) @ 85 °C**		Order Code
	Minimum	Maximum	Group	Flux (lm) @ 85 °C	Flux (lm) @ 25 °C*	700 mA	1.0 A	
Cool White	5000 K	8300 K	R3	122	141	210	270	XQEAWT-00-0000-00000LFE1
			R2	114	132	196	252	XQEAWT-00-0000-00000LEE1
70-CRI White	3700 K	8300 K	R3	122	141	210	270	XQEAWT-00-0000-00000BFE1
			R2	114	132	196	252	XQEAWT-00-0000-00000BEE1
Neutral White	3700 K	5300 K	R2	114	132	196	252	XQEAWT-00-0000-00000LEE4
			Q5	107	124	184	237	XQEAWT-00-0000-00000LDE4
			Q4	100	116	172	221	XQEAWT-00-0000-00000LCE4
Warm White	2700 K	3500 K	Q5	107	124	184	237	XQEAWT-00-0000-00000LDE7
			Q4	100	116	172	221	XQEAWT-00-0000-00000LCE7
			Q3	93.9	109	162	208	XQEAWT-00-0000-00000LBE7
			Q2	87.4	101	150	193	XQEAWT-00-0000-00000LAE7
80-CRI White	2700 K	3500 K	Q5	107	124	184	237	XQEAWT-00-0000-00000HDE7
			Q4	100	116	172	221	XQEAWT-00-0000-00000HCE7
			Q3	93.9	109	162	208	XQEAWT-00-0000-00000HBE7
			Q2	87.4	101	150	193	XQEAWT-00-0000-00000HAE7
90-CRI White	2850 K	3000 K	P4	80.6	93.3	139	178	XQEAWT-00-0000-00000U9E7
			P3	73.9	85.5	127	163	XQEAWT-00-0000-00000U8E7
			P2	67.2	77.8	116	149	XQEAWT-00-0000-00000U7E7
			N4	62	71.7	107	137	XQEAWT-00-0000-00000U6E7

### Notes:

- Cree maintains a tolerance of  $\pm 7\%$  on flux and power measurements,  $\pm 0.005$  on chromaticity (CCx, CCy) measurements and  $\pm 2$  on CRI measurements. See the Measurements section (page 24).
- Typical CRI for Cool White (5000 K – 8300 K CCT) is 70.
- Typical CRI for Neutral White (3700 K – 5300 K CCT) is 75.
- Typical CRI for Warm White (2700 K – 3500 K CCT) is 80.
- Minimum CRI for 70-CRI White is 70.
- Minimum CRI for 80-CRI White is 80.
- Minimum CRI for 90-CRI White is 90.
- \* Flux values @ 25 °C are calculated and for reference only.
- \*\* Calculated flux values at 700 mA and 1 A are for reference only.

**FLUX CHARACTERISTICS - HIGH DENSITY COLOR ( $T_j = 25\text{ }^\circ\text{C}$ )**

The following tables provide several base order codes for XLamp XQ-E High Density color LEDs. It is important to note that the base order codes listed here are a subset of the total available order codes for the product family. For more order codes, as well as a complete description of the order-code nomenclature, please consult the XLamp XQ Family LEDs Binning and Labeling document.

Color	Dominant Wavelength Range				Minimum Radiant Flux (mW) @ 350 mA		Calculated Minimum PPF ( $\mu\text{mol/s}$ )*	Order Code
	Minimum		Maximum		Group	Flux (mW)		
	Group	DWL (nm)	Group	DWL (nm)				
Royal Blue	D36	450	D57	465	36 (Q)	600	2.27	XQEROY-00-0000-000000Q01
					35 (P)	575	2.18	XQEROY-00-0000-000000P01
					34 (N)	550	2.08	XQEROY-00-0000-000000N01
					33 (M)	525	1.99	XQEROY-00-0000-000000M01
					32 (L)	500	1.90	XQEROY-00-0000-000000L01
					31 (K)	475	1.80	XQEROY-00-0000-000000K01
					30 (J)	450	1.71	XQEROY-00-0000-000000J01

Color	Dominant Wavelength Range				Minimum Luminous Flux (lm) @ 350 mA		Order Code
	Minimum		Maximum		Group	Flux (lm)	
	Group	DWL (nm)	Group	DWL (nm)			
Blue	B3	465	B6	485	M3	45.7	XQEBLU-00-0000-000000301
					M2	39.8	XQEBLU-00-0000-000000201
					K3	35.2	XQEBLU-00-0000-000000Z01
					K2	30.6	XQEBLU-00-0000-000000Y01

Color	Dominant Wavelength Range				Minimum Luminous Flux (lm) @ 350 mA		Calculated Minimum PPF ( $\mu\text{mol/s}$ )*	Order Code
	Minimum		Maximum		Group	Flux (lm)		
	Group	DWL (nm)	Group	DWL (nm)				
Green	G2	520	G4	535	Q5	107	0.98	XQEGRN-00-0000-000000D01
					Q4	100	0.91	XQEGRN-00-0000-000000C01
					Q3	93.9	0.86	XQEGRN-00-0000-000000B01

- Note
- Cree maintains a tolerance of  $\pm 7\%$  on flux and power measurements,  $\pm 0.005$  on chromaticity (CCx, CCy) measurements and a tolerance of  $\pm 2$  on CRI measurements. See the Measurements section (page 24).
  - \* Photosynthetic Photon Flux (PPF) values are calculated and for reference only.

**FLUX CHARACTERISTICS - HIGH DENSITY COLOR (T<sub>j</sub> = 25 °C) - CONTINUED**

Color	Color Bin	Minimum Luminous Flux (lm) @ 350 mA		Order Code
		Group	Flux (lm)	
PC Amber	Y2	P4	80.6	XQEAPA-00-0000-000000901
		P3	73.9	XQEAPA-00-0000-000000801

Color	Dominant Wavelength Range				Minimum Luminous Flux (lm) @ 350 mA		Order Code
	Minimum		Maximum		Group	Flux (lm)	
	Group	DWL (nm)	Group	DWL (nm)			
Red-Orange	O3	610	O4	620	Q3	93.9	XQERDO-00-0000-000000B01
					Q2	87.4	XQERDO-00-0000-000000A01
					P4	80.6	XQERDO-00-0000-000000901
					P3	73.9	XQERDO-00-0000-000000801
					P2	67.2	XQERDO-00-0000-000000701

Color	Dominant Wavelength Range				Minimum Luminous Flux (lm) @ 350 mA		Calculated Minimum PPF (µmol/s)*	Order Code
	Minimum		Maximum		Group	Flux (lm)		
	Group	DWL (nm)	Group	DWL (nm)				
Red	R2	620	R3	630	P3	73.9	1.92	XQERED-00-0000-000000801
					P2	67.2	1.75	XQERED-00-0000-000000701
					N4	62	1.61	XQERED-00-0000-000000601
					N3	56.8	1.48	XQERED-00-0000-000000501

Color	Peak Wavelength Range				Minimum Radiant Flux (mW) @ 350 mA		Calculated Minimum PPF (µmol/s)*	Order Code
	Min.		Max.		Group	Flux (mW)		
	Group	PWL (nm)	Group	PWL (nm)				
HE Photo Red	P2	650	P5	670	27	375	2.06	XQEEPR-00-0000-000000A01
					26	350	1.93	XQEEPR-00-0000-000000901

- Note
- Cree maintains a tolerance of ±7% on flux and power measurements, ±0.005 on chromaticity (CCx, CCy) measurements and a tolerance of ±2 on CRI measurements. See the Measurements section (page 24).
  - \* Photosynthetic Photon Flux (PPF) values are calculated and for reference only.

## FLUX CHARACTERISTICS - HIGH INTENSITY WHITE ( $T_j = 85\text{ }^\circ\text{C}$ )

The following table provides several base order codes for XLamp XQ-E High Intensity white LEDs. It is important to note that the base order codes listed here are a subset of the total available order codes for the product family. For more order codes, as well as a complete description of the order-code nomenclature, please consult the XLamp XQ Family LEDs Binning and Labeling document.

Color	CCT Range		Minimum Luminous Flux (lm) @ 350 mA			Calculated Minimum Luminous Flux (lm) @ 85 °C**		Order Code
	Minimum	Maximum	Group	Flux (lm) @ 85 °C	Flux (lm) @ 25 °C*	700 mA	1.0 A	
Cool White	5000 K	8300 K	R3	122	136	213	276	XQEAWT-H0-0000-00000LFE1
			R2	114	127	199	258	XQEAWT-H0-0000-00000LEE1
70-CRI White	3700 K	8300 K	R3	122	136	213	276	XQEAWT-H0-0000-00000BFE1
			R2	114	127	199	258	XQEAWT-H0-0000-00000BEE1
Neutral White	3700 K	5300 K	R2	114	127	199	258	XQEAWT-H0-0000-00000LEE4
			Q5	107	119	187	242	XQEAWT-H0-0000-00000LDE4
			Q4	100	111	175	226	XQEAWT-H0-0000-00000LCE4
Warm White	2700 K	3500 K	Q5	107	119	187	242	XQEAWT-H0-0000-00000LDE7
			Q4	100	111	175	226	XQEAWT-H0-0000-00000LCE7
			Q3	93.9	105	164	213	XQEAWT-H0-0000-00000LBE7
80-CRI White	2700 K	3500 K	Q5	107	119	187	242	XQEAWT-H0-0000-00000HDE7
			Q4	100	111	175	226	XQEAWT-H0-0000-00000HCE7
			Q3	93.9	105	164	213	XQEAWT-H0-0000-00000HBE7
90-CRI White	2850 K	3000 K	P4	80.6	89.9	141	182	XQEAWT-H0-0000-00000U9E7
			P3	73.9	82.4	129	167	XQEAWT-H0-0000-00000U8E7
			P2	67.2	74.9	117	152	XQEAWT-H0-0000-00000U7E7

### Notes:

- Cree maintains a tolerance of  $\pm 7\%$  on flux and power measurements,  $\pm 0.005$  on chromaticity (CCx, CCy) measurements and  $\pm 2$  on CRI measurements. See the Measurements section (page 24).
- Typical CRI for Cool White (5000 K – 8300 K CCT) is 70.
- Typical CRI for Neutral White (3700 K – 5300 K CCT) is 75.
- Typical CRI for Warm White (2700 K – 3500 K CCT) is 80.
- Minimum CRI for 70-CRI White is 70.
- Minimum CRI for 80-CRI White is 80.
- Minimum CRI for 90-CRI White is 90.
- \* Flux values @ 25 °C are calculated and for reference only.
- \*\* Calculated flux values at 700 mA and 1 A are for reference only.

**FLUX CHARACTERISTICS - HIGH INTENSITY COLOR ( $T_j = 25\text{ }^\circ\text{C}$ )**

The following tables provide several base order codes for XLamp XQ-E High Intensity color LEDs. It is important to note that the base order codes listed here are a subset of the total available order codes for the product family. For more order codes, as well as a complete description of the order-code nomenclature, please consult the XLamp XQ Family LEDs Binning and Labeling document.

Color	Dominant Wavelength Range				Minimum Radiant Flux (mW) @ 350 mA		Calculated Minimum PPF ( $\mu\text{mol/s}$ )*	Order Code
	Minimum		Maximum		Group	Flux (mW)		
	Group	DWL (nm)	Group	DWL (nm)				
Royal Blue	D36	450	D57	465	P	575	2.18	XQEROY-H0-0000-000000P01
					N	550	2.08	XQEROY-H0-0000-000000N01
					M	525	1.99	XQEROY-H0-0000-000000M01

Color	Dominant Wavelength Range				Minimum Luminous Flux (lm) @ 350 mA		Order Code
	Minimum		Maximum		Group	Flux (lm)	
	Group	DWL (nm)	Group	DWL (nm)			
Blue	B3	465	B6	485	M2	39.8	XQEBLU-H0-0000-000000201
					K3	35.2	XQEBLU-H0-0000-000000Z01
					K2	30.6	XQEBLU-H0-0000-000000Y01

Color	Dominant Wavelength Range				Minimum Luminous Flux (lm) @ 350 mA		Calculated Minimum PPF ( $\mu\text{mol/s}$ )*	Order Code
	Minimum		Maximum		Group	Flux (lm)		
	Group	DWL (nm)	Group	DWL (nm)				
Green	G2	520	G4	535	Q5	107	0.98	XQEGRN-H0-0000-000000D01
					Q4	100	0.91	XQEGRN-H0-0000-000000C01
					Q3	93.9	0.86	XQEGRN-H0-0000-000000B01
					Q2	87.4	0.80	XQEGRN-H0-0000-000000A01
					P4	80.6	0.74	XQEGRN-H0-0000-000000901

Color	Color Bin	Minimum Luminous Flux (lm) @ 350 mA		Order Code
		Group	Flux (lm)	
PC Amber	Y2	P3	73.9	XQEAPA-H0-0000-000000801
		P2	67.2	XQEAPA-H0-0000-000000701

- Note**
- Cree maintains a tolerance of  $\pm 7\%$  on flux and power measurements,  $\pm 0.005$  on chromaticity (CCx, CCy) measurements and a tolerance of  $\pm 2$  on CRI measurements. See the Measurements section (page 24).
  - \* Photosynthetic Photon Flux (PPF) values are calculated and for reference only.

**FLUX CHARACTERISTICS - HIGH INTENSITY COLOR ( $T_j = 25\text{ }^\circ\text{C}$ ) - CONTINUED**

Color	Dominant Wavelength Range				Minimum Luminous Flux (lm) @ 350 mA		Order Code
	Minimum		Maximum		Group	Flux (lm)	
	Group	DWL (nm)	Group	DWL (nm)			
Red-Orange	O3	610	O4	620	P3	73.9	XQERDO-H0-0000-000000801
					P2	67.2	XQERDO-H0-0000-000000701
					N4	62	XQERDO-H0-0000-000000601

Color	Dominant Wavelength Range				Minimum Luminous Flux (lm) @ 350 mA		Calculated Minimum PPF ( $\mu\text{mol/s}$ )*	Order Code
	Minimum		Maximum		Group	Flux (lm)		
	Group	DWL (nm)	Group	DWL (nm)				
Red	R2	620	R3	630	N2	51.7	1.35	XQERED-H0-0000-000000401
					M3	45.7	1.19	XQERED-H0-0000-000000301
					M2	39.8	1.04	XQERED-H0-0000-000000201

- Note**
- Cree maintains a tolerance of  $\pm 7\%$  on flux and power measurements,  $\pm 0.005$  on chromaticity (CCx, CCy) measurements and a tolerance of  $\pm 2$  on CRI measurements. See the Measurements section (page 24).
  - \* Photosynthetic Photon Flux (PPF) values are calculated and for reference only.



**RELATIVE SPECTRAL POWER DISTRIBUTION**

**High Density**



**High Density Color**

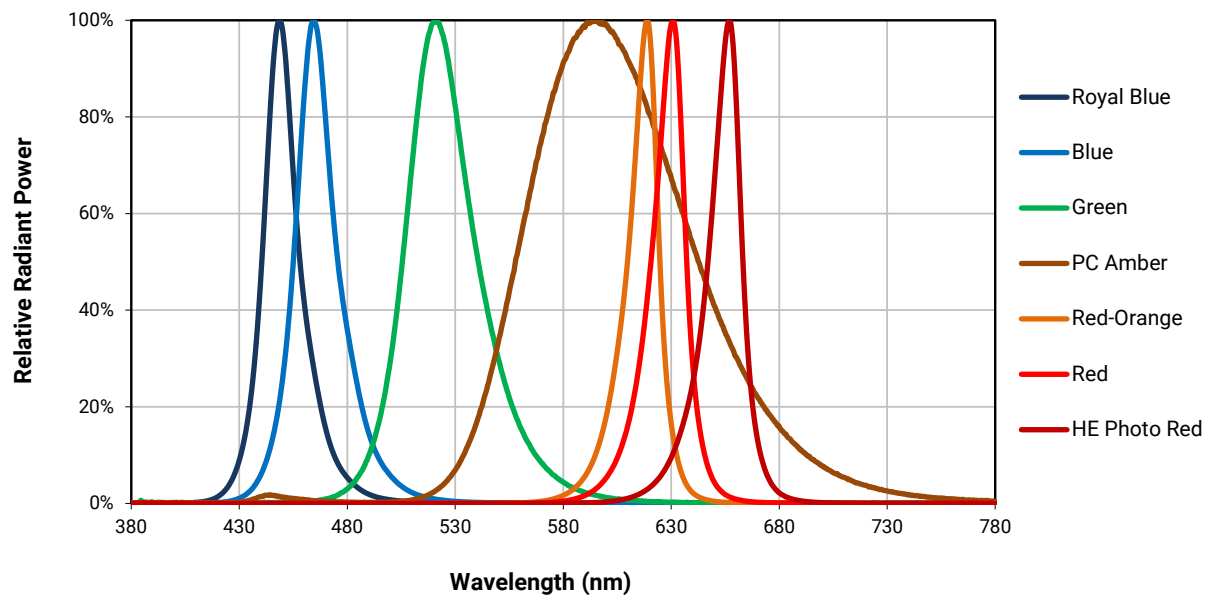

**RELATIVE SPECTRAL POWER DISTRIBUTION - CONTINUED**

**High Intensity**

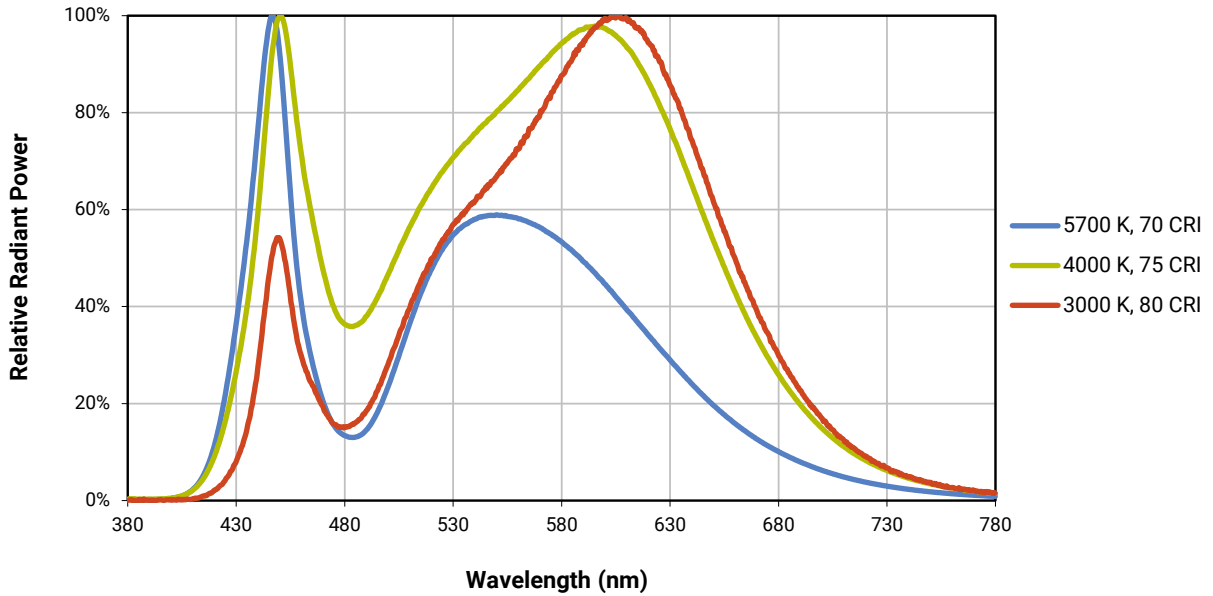

**High Intensity Color**

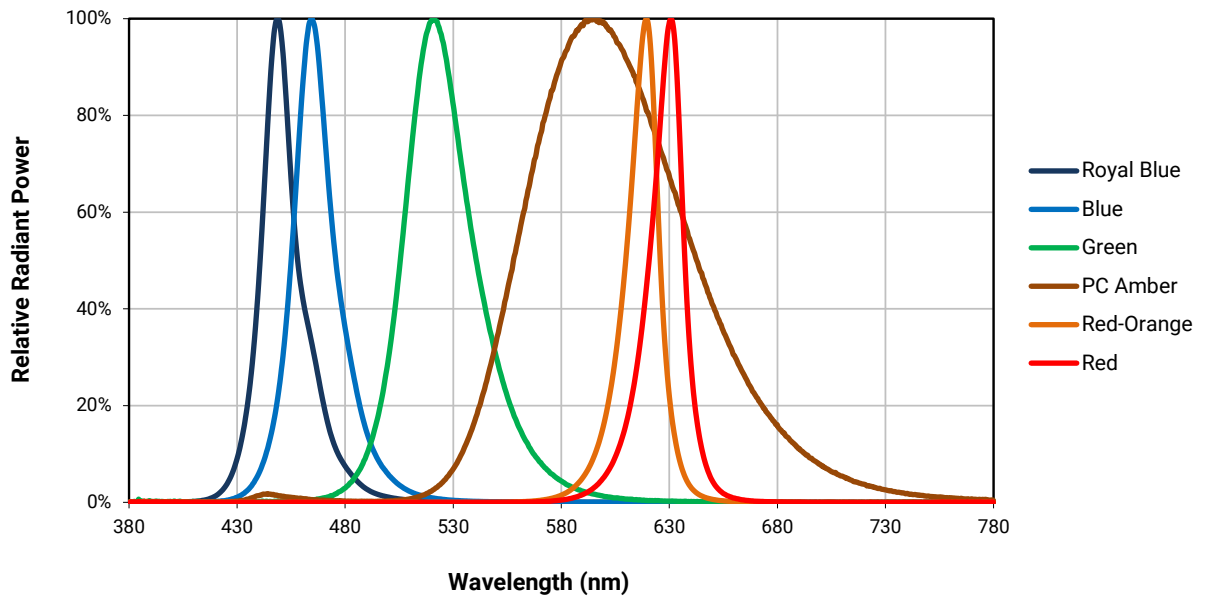

**RELATIVE FLUX VS. JUNCTION TEMPERATURE ( $I_F = 350$  mA)**

**High Density**

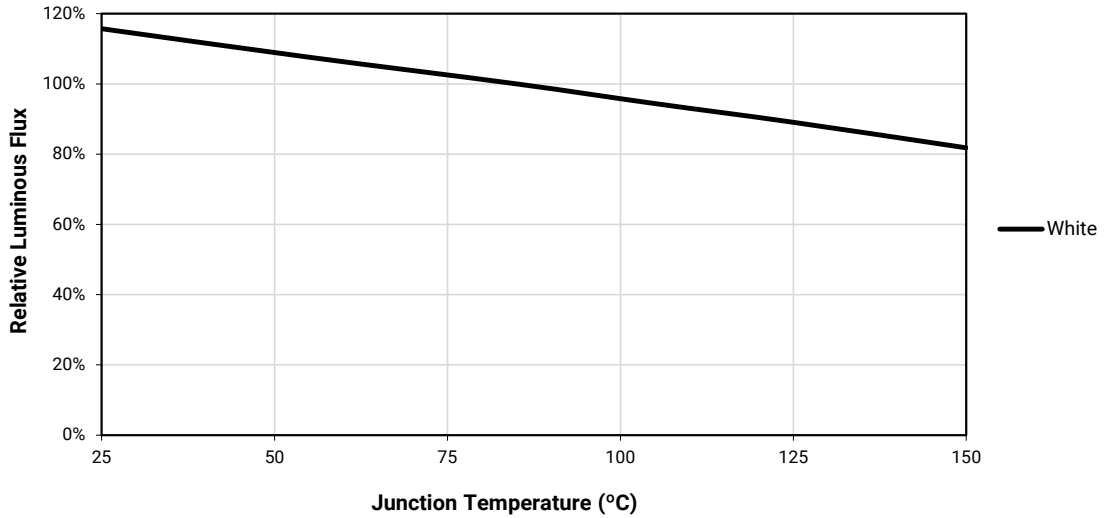

**High Density Color**

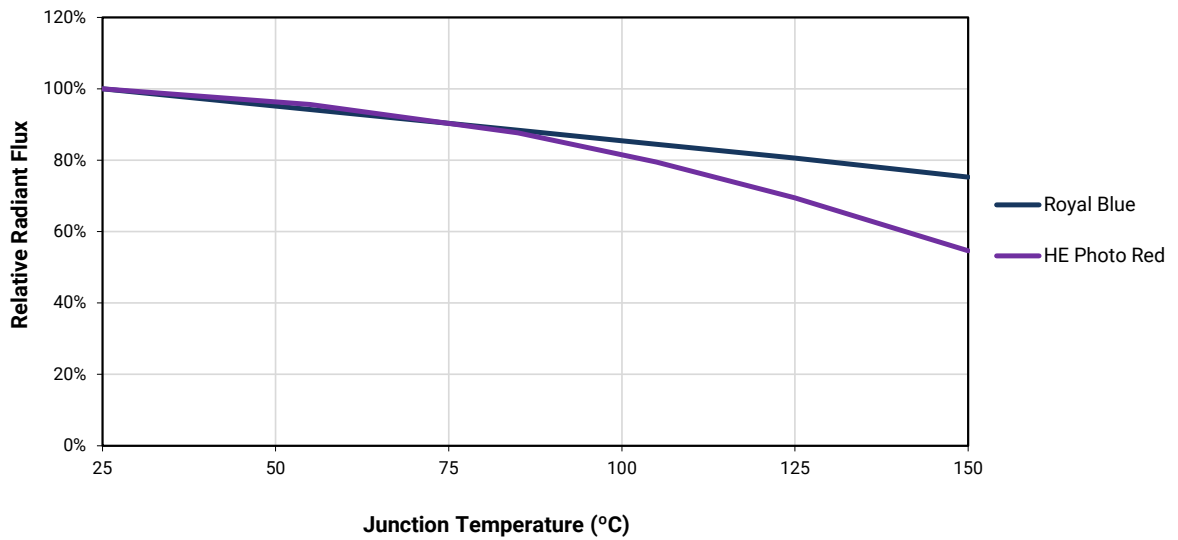

**RELATIVE FLUX VS. JUNCTION TEMPERATURE ( $I_F = 350$  mA) - CONTINUED**

**High Density Color**

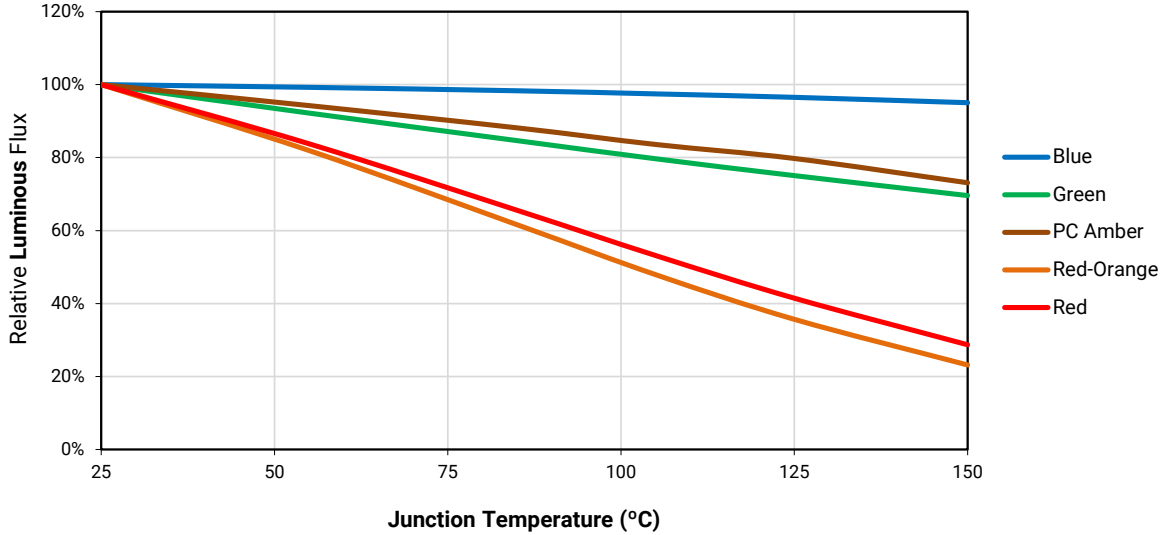

**High Intensity**

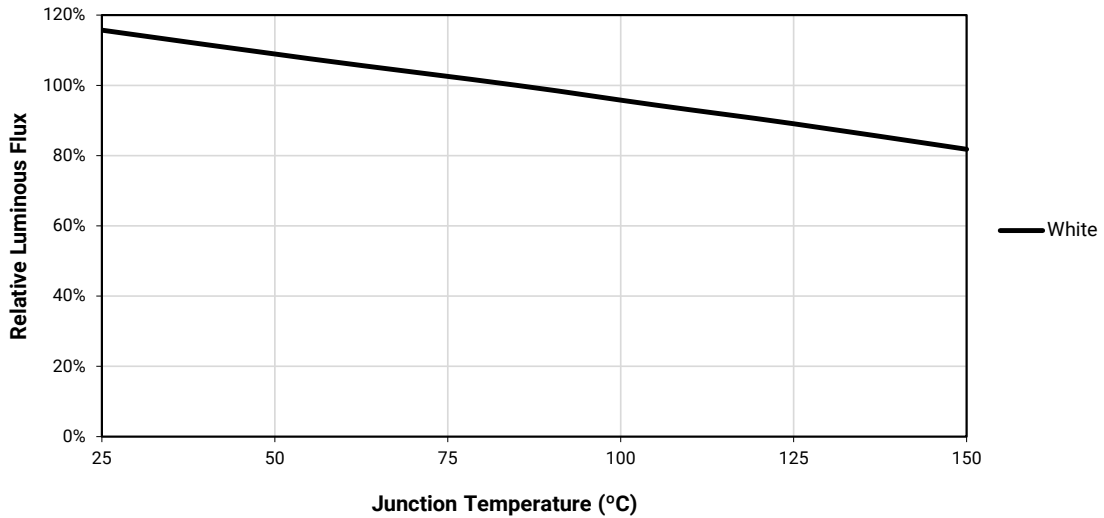

**RELATIVE FLUX VS. JUNCTION TEMPERATURE ( $I_F = 350$  mA) - CONTINUED**

**High Intensity Color**

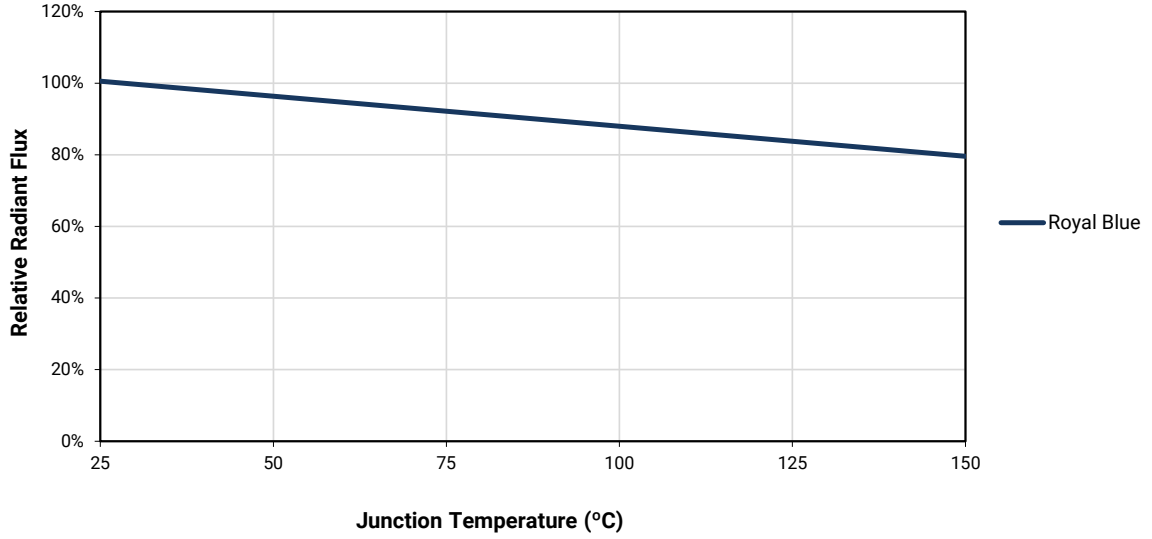

**High Intensity Color**

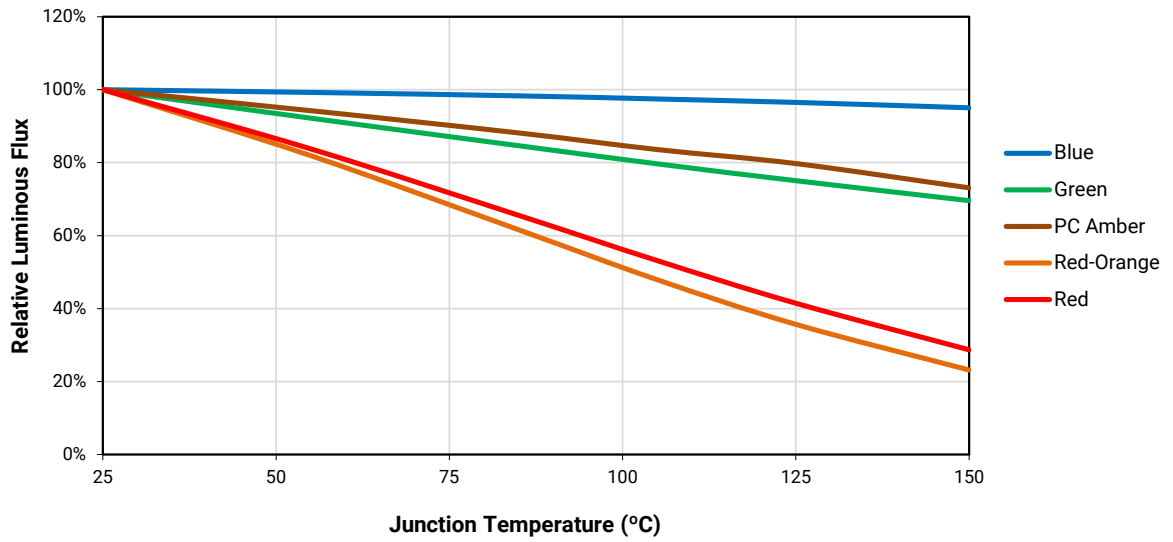

**ELECTRICAL CHARACTERISTICS ( $T_j = 85\text{ }^\circ\text{C}$ )**

**High Density**

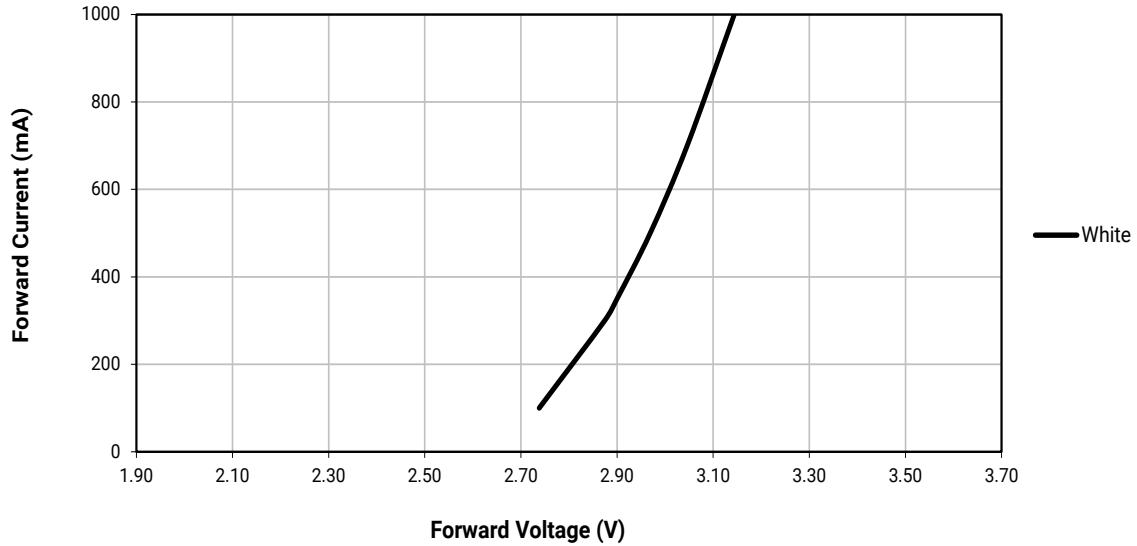

**High Density Color**

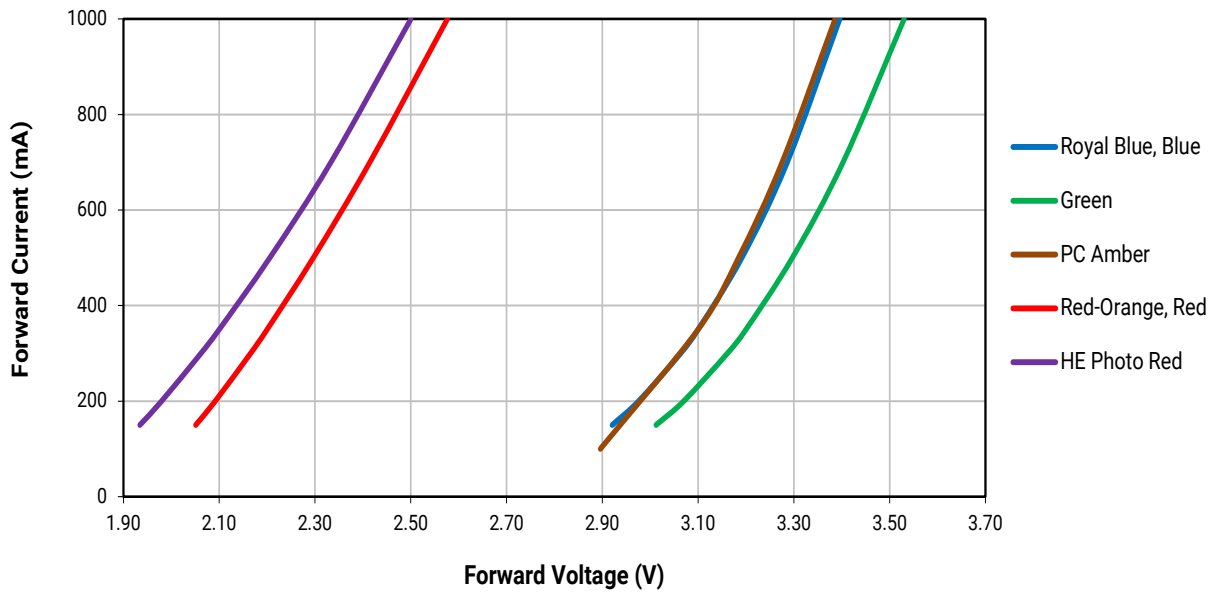

**ELECTRICAL CHARACTERISTICS ( $T_j = 25\text{ }^\circ\text{C}$ ) - CONTINUED**

**High Intensity**

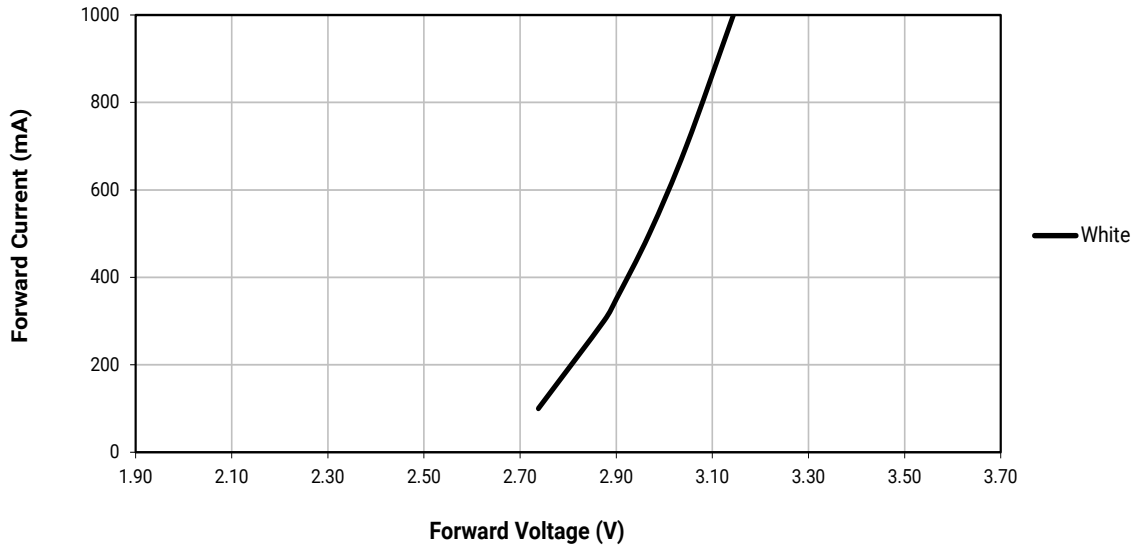

**High Intensity Color**

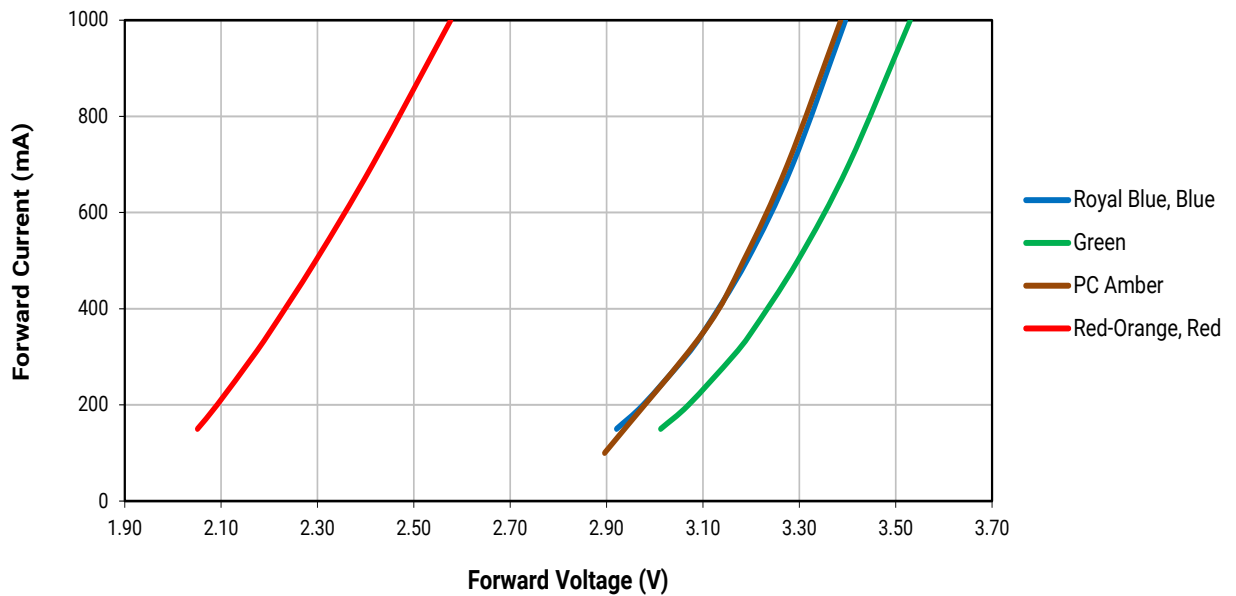

**RELATIVE FLUX VS. CURRENT ( $T_j = 85\text{ }^\circ\text{C}$ )**

**High Density**

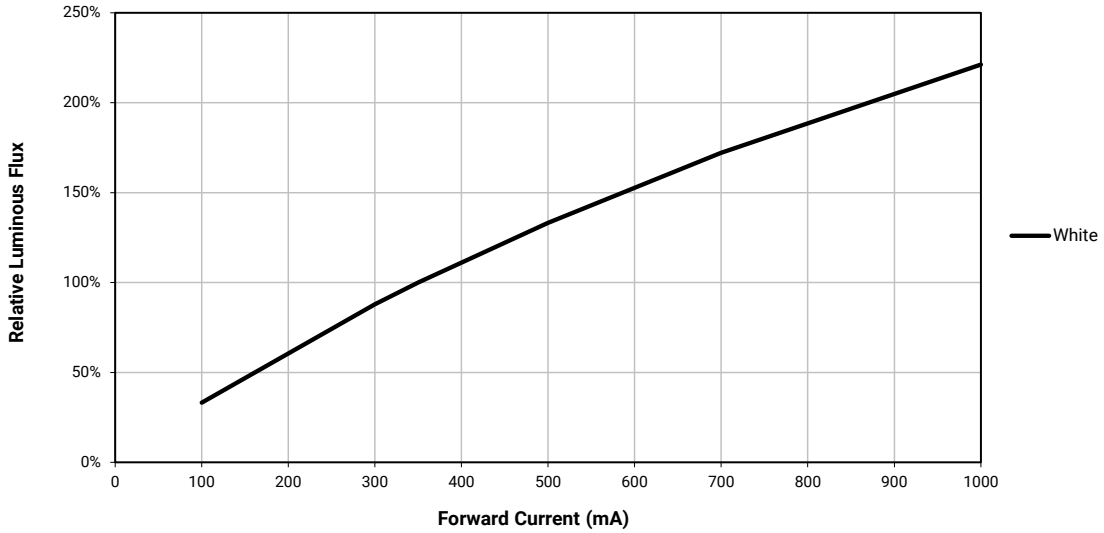

**High Density Color**





**RELATIVE FLUX VS. CURRENT ( $T_j = 25\text{ }^\circ\text{C}$ ) - CONTINUED**

**High Density Color**

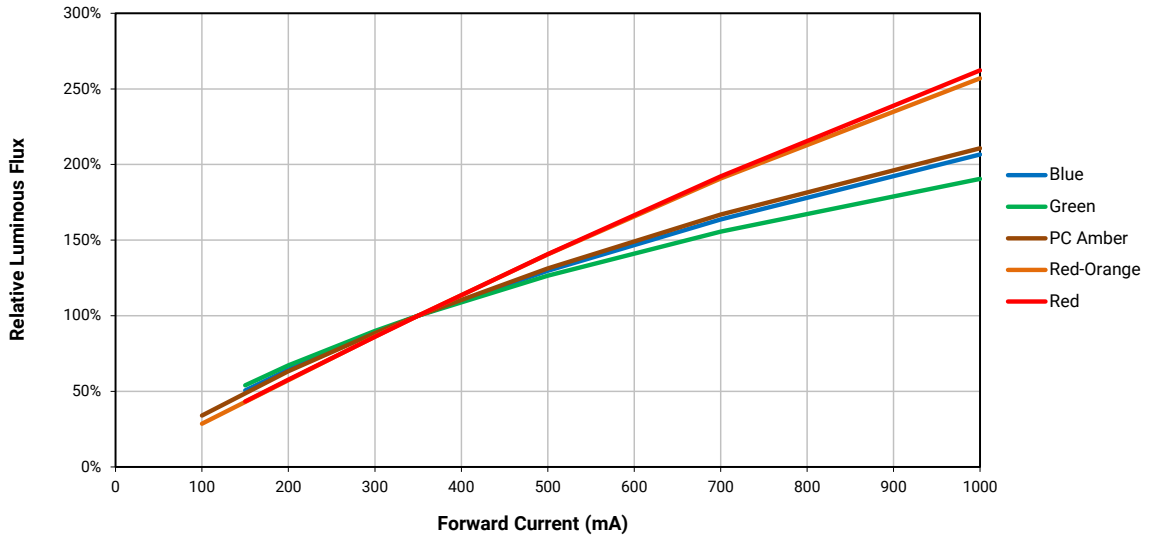

**High Intensity**

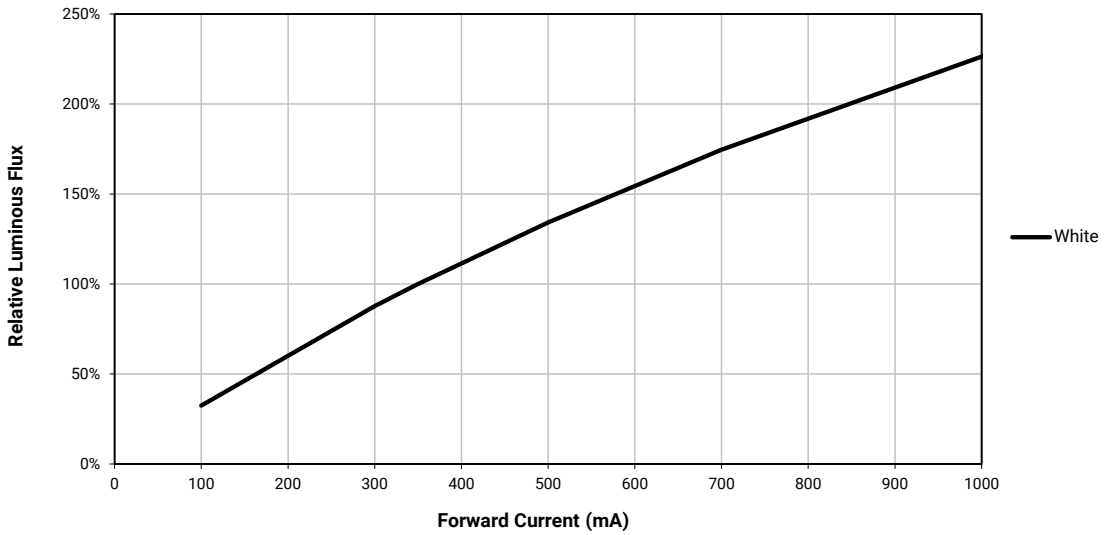

**RELATIVE FLUX VS. CURRENT ( $T_j = 25\text{ }^\circ\text{C}$ ) - CONTINUED**

**High Intensity Color**



**High Intensity Color**

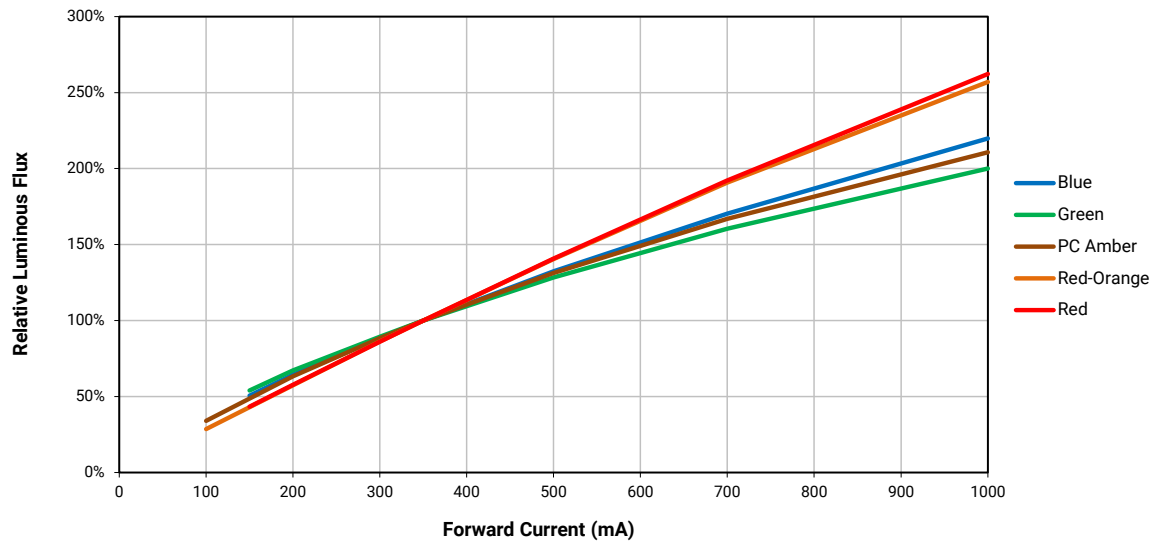

**TYPICAL SPATIAL DISTRIBUTION**

**High Density**

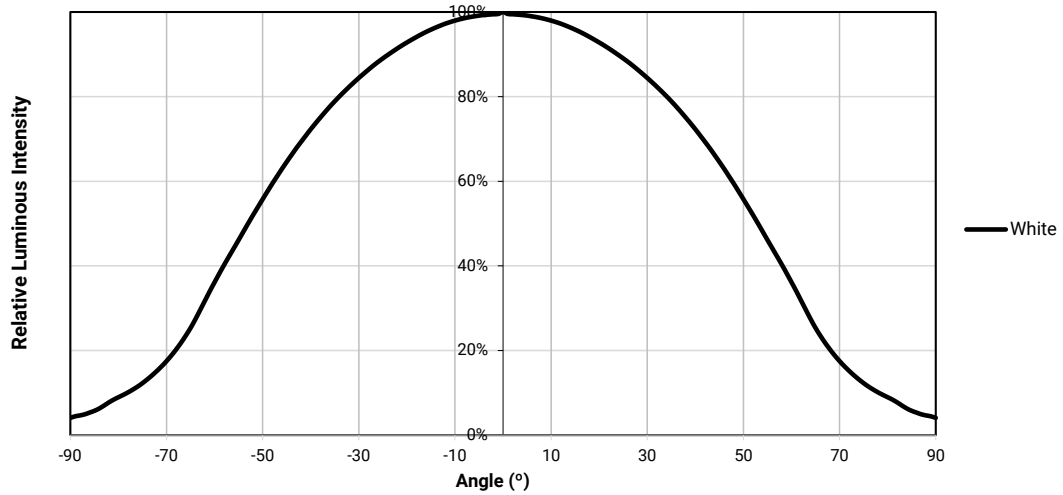

**High Density Color**

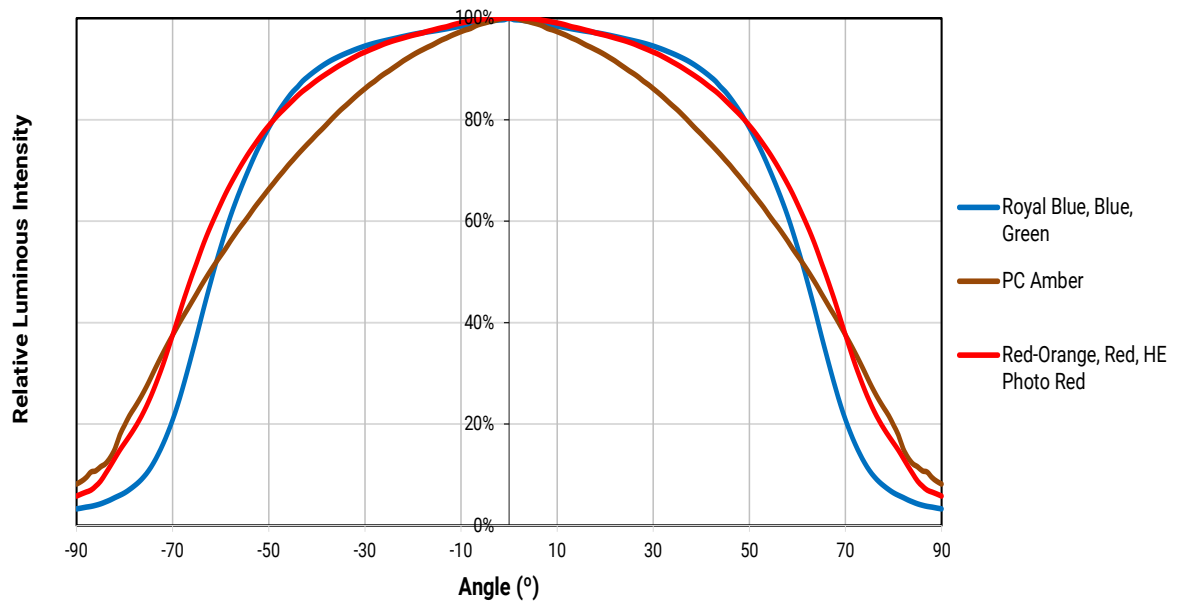

**TYPICAL SPATIAL DISTRIBUTION - CONTINUED**

**High Intensity**

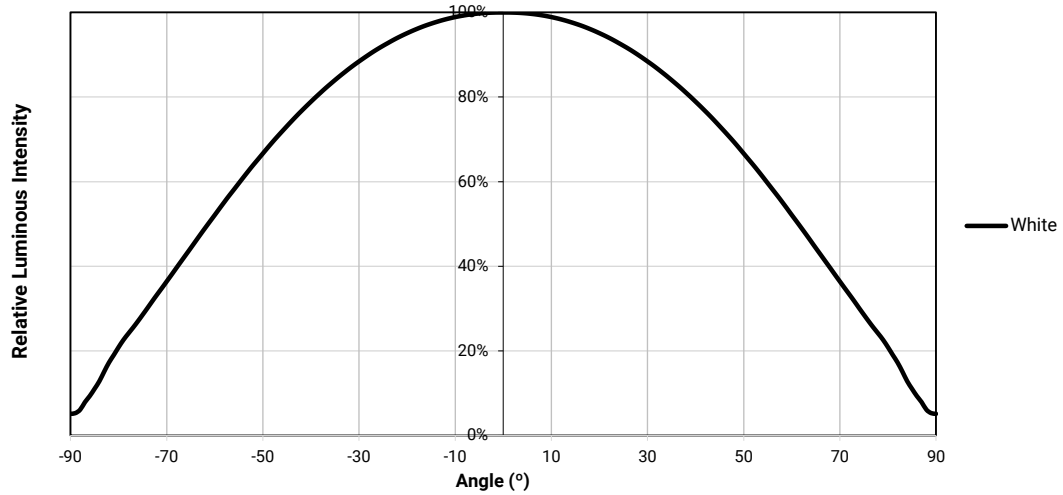

**High Intensity Color**

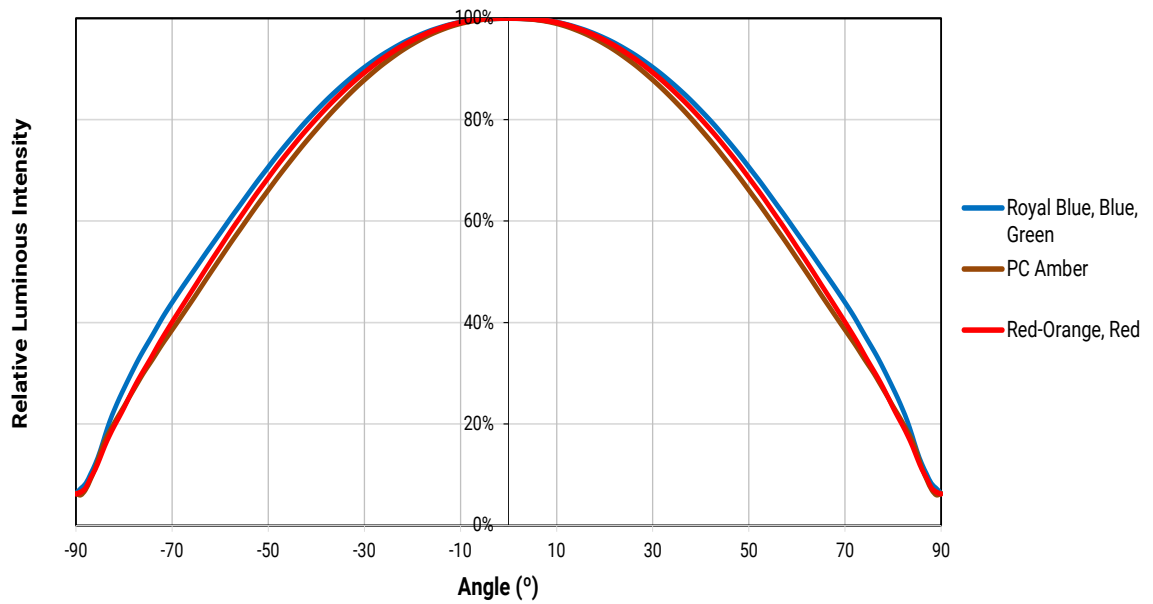

**THERMAL DESIGN**

The maximum forward current is determined by the thermal resistance between the LED junction and ambient. It is crucial for the end product to be designed in a manner that minimizes the thermal resistance from the solder point to ambient in order to optimize lamp life and optical characteristics.

**High Density**

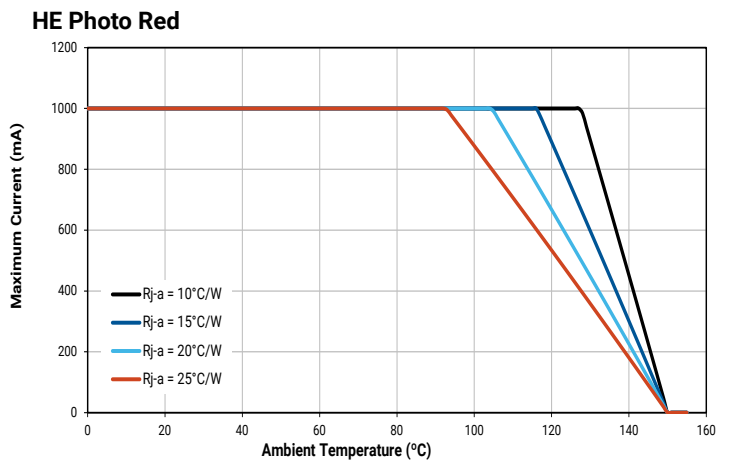
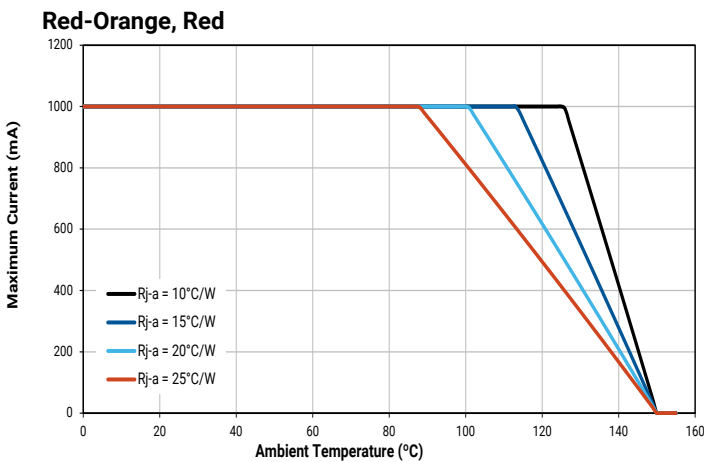
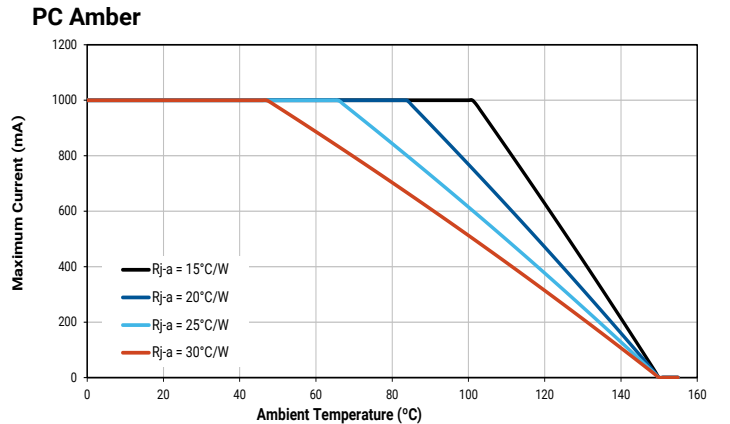
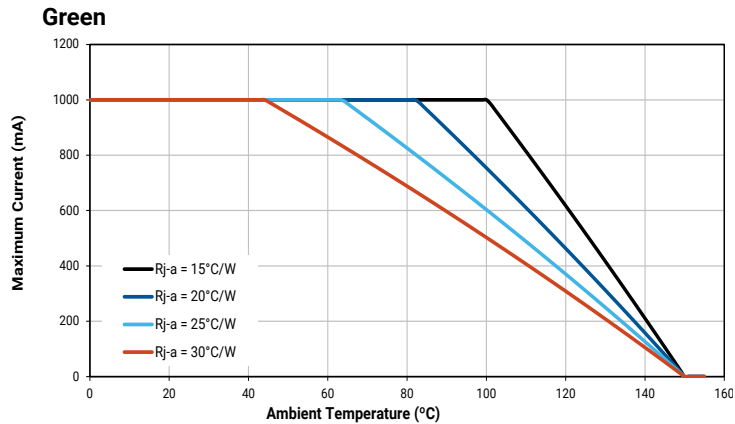
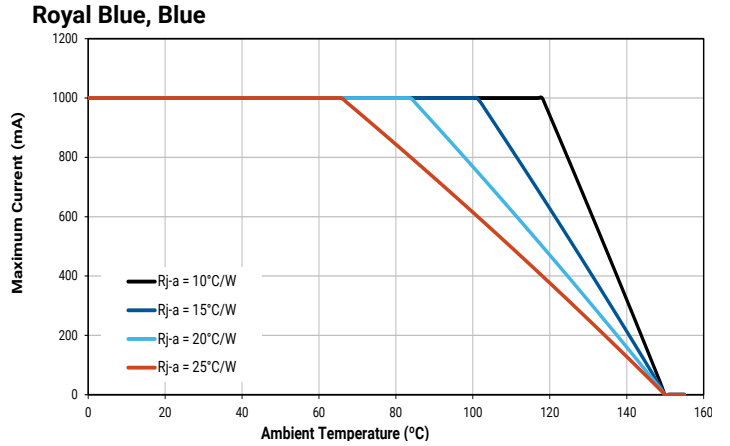
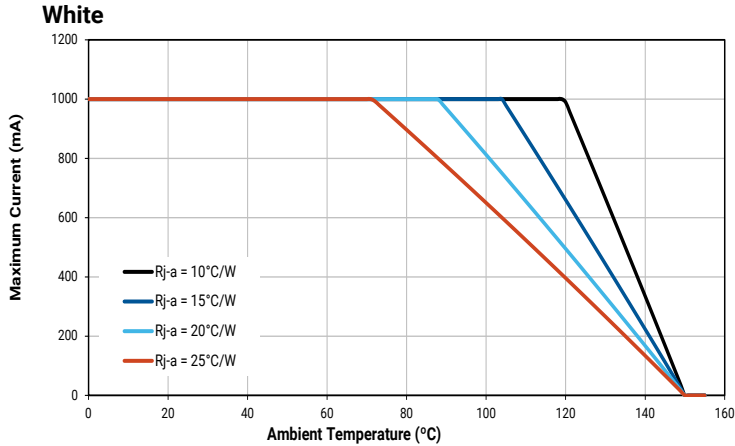

**THERMAL DESIGN - CONTINUED**

The maximum forward current is determined by the thermal resistance between the LED junction and ambient. It is crucial for the end product to be designed in a manner that minimizes the thermal resistance from the solder point to ambient in order to optimize lamp life and optical characteristics.

**High Intensity**

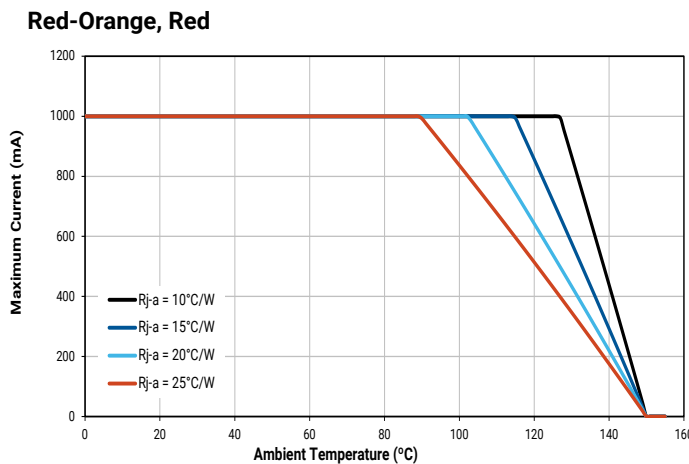
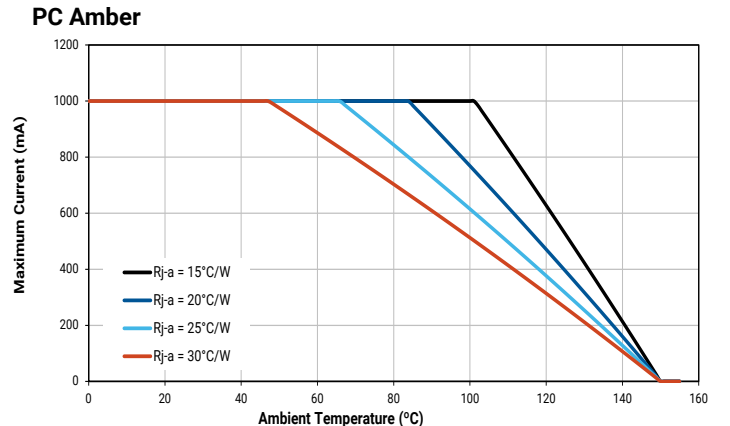
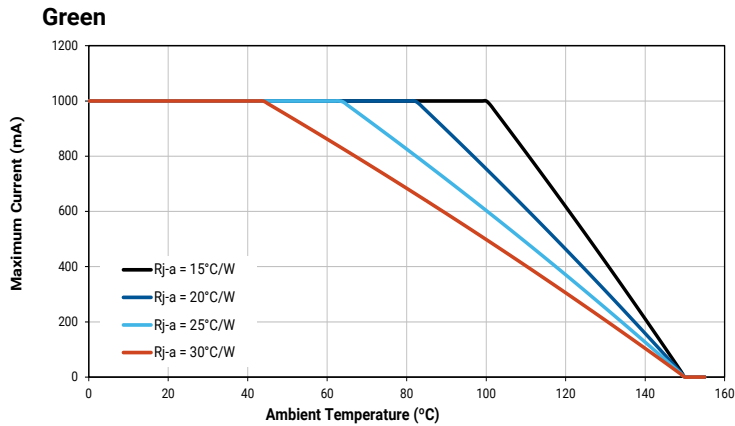
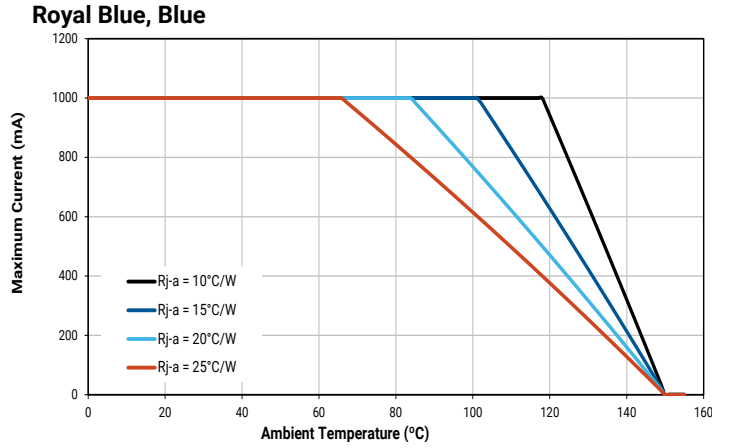
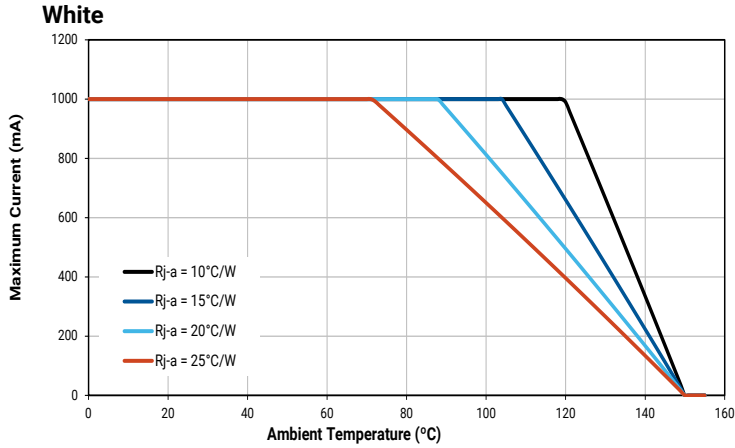

**REFLOW SOLDERING CHARACTERISTICS**

In testing, Cree has found XLamp XQ-E LEDs to be compatible with JEDEC J-STD-020C, using the parameters listed below. As a general guideline, Cree recommends that users follow the recommended soldering profile provided by the manufacturer of the solder paste used.

Note that this general guideline may not apply to all PCB designs and configurations of reflow soldering equipment.

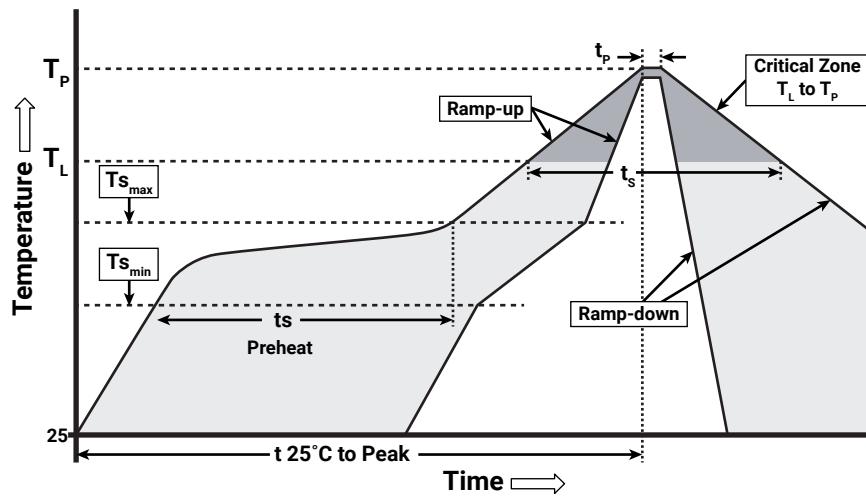

IPC/JEDEC J-STD-020C

Profile Feature	Lead-Free Solder
Average Ramp-Up Rate ( $T_{s_{max}}$ to $T_P$ )	1.2 °C/second
Preheat: Temperature Min ( $T_{s_{min}}$ )	120 °C
Preheat: Temperature Max ( $T_{s_{max}}$ )	170 °C
Preheat: Time ( $t_{s_{min}}$ to $t_{s_{max}}$ )	65-150 seconds
Time Maintained Above: Temperature ( $T_L$ )	217 °C
Time Maintained Above: Time ( $t_s$ )	45-90 seconds
Peak/Classification Temperature ( $T_P$ )	235 - 245 °C
Time Within 5 °C of Actual Peak Temperature ( $t_p$ )	20-40 seconds
Ramp-Down Rate	1 - 6 °C/second
Time 25 °C to Peak Temperature	4 minutes max.

Note: All temperatures refer to topside of the package, measured on the package body surface.

## NOTES

---

### Measurements

The luminous flux, radiant power, chromaticity, forward voltage and CRI measurements in this document are binning specifications only and solely represent product measurements as of the date of shipment. These measurements will change over time based on a number of factors that are not within Cree's control and are not intended or provided as operational specifications for the products. Calculated values are provided for informational purposes only and are not intended as specifications.

### Pre-Release Qualification Testing

Please read the [LED Reliability Overview](#) for details of the qualification process Cree applies to ensure long-term reliability for XLamp LEDs and details of Cree's pre-release qualification testing for XLamp LEDs.

### Lumen Maintenance

Cree now uses standardized IES LM-80-08 and TM-21-11 methods for collecting long-term data and extrapolating LED lumen maintenance. For information on the specific LM-80 data sets available for this LED, refer to the public [LM-80 results document](#).

Please read the [Long-Term Lumen Maintenance application note](#) for more details on Cree's lumen maintenance testing and forecasting. Please read the [Thermal Management application note](#) for details on how thermal design, ambient temperature, and drive current affect the LED junction temperature.

### Moisture Sensitivity

Cree recommends keeping XLamp LEDs in the provided, resealable moisture-barrier packaging (MBP) until immediately prior to soldering. Unopened MBPs that contain XLamp LEDs do not need special storage for moisture sensitivity.

Once the MBP is opened, XLamp XQ-E LEDs may be stored as MSL 1 per JEDEC J-STD-033, meaning they have unlimited floor life in conditions of  $\leq 30$  °C/85% relative humidity (RH). Regardless of storage condition, Cree recommends sealing any unsoldered LEDs in the original MBP.

### RoHS Compliance

The levels of RoHS restricted materials in this product are below the maximum concentration values (also referred to as the threshold limits) permitted for such substances, or are used in an exempted application, in accordance with EU Directive 2011/65/EC (RoHS2), as implemented January 2, 2013. RoHS Declarations for this product can be obtained from your Cree representative or from the [Product Ecology](#) section of the Cree website.

### REACH Compliance

REACH substances of very high concern (SVHCs) information is available for this product. Since the European Chemical Agency (ECHA) has published notice of their intent to frequently revise the SVHC listing for the foreseeable future, please contact a Cree representative to insure you get the most up-to-date REACH SVHC Declaration. REACH banned substance information (REACH Article 67) is also available upon request.



**NOTES - CONTINUED**

---

**UL® Recognized Component**

Level 1 enclosure consideration. The LED package or a portion thereof has not been investigated as a fire enclosure or a fire and electrical enclosure per ANSI/UL 8750.

**Vision Advisory**

WARNING: Do not look at an exposed lamp in operation. Eye injury can result. For more information about LEDs and eye safety, please refer to the [LED Eye Safety application note](#).

**MECHANICAL DIMENSIONS**

Thermal vias, if present, are not shown on these drawings.

All dimensions in mm.

Measurement tolerances unless indicated otherwise: ±.13 mm

**High Density**

XQEAWT-0x-xxxx-xxxxxxxxx  
 XQ-E High Density

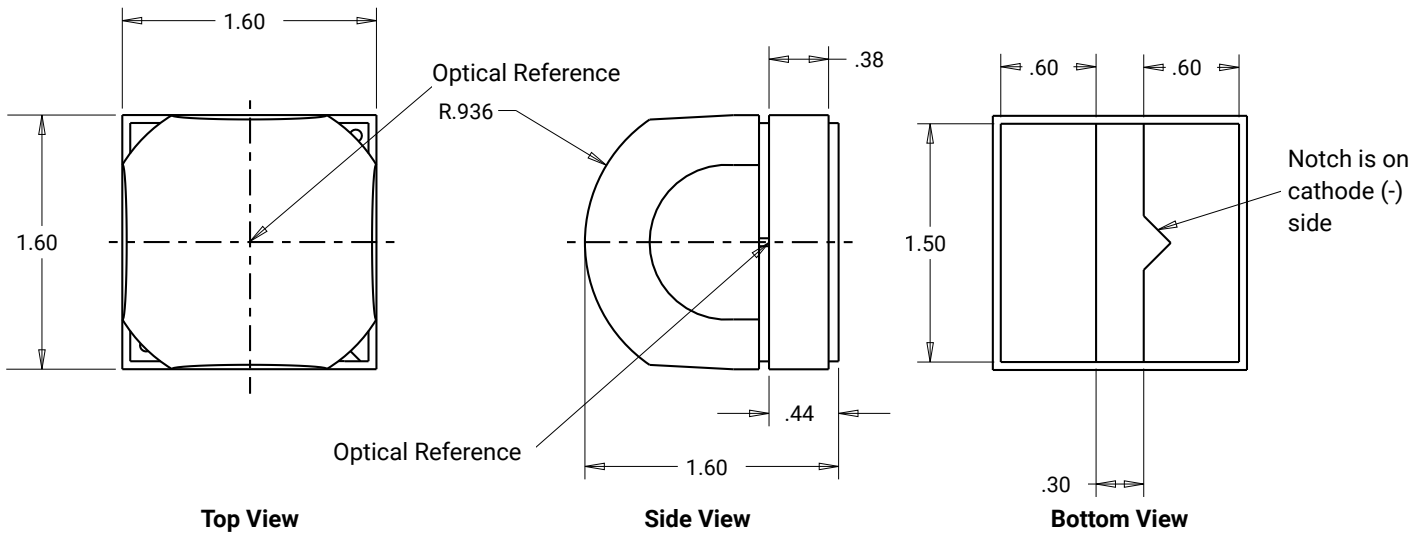

**High Intensity**

XQEAWT-Hx-xxxx-xxxxxxxxx  
 XQ-E High Intensity

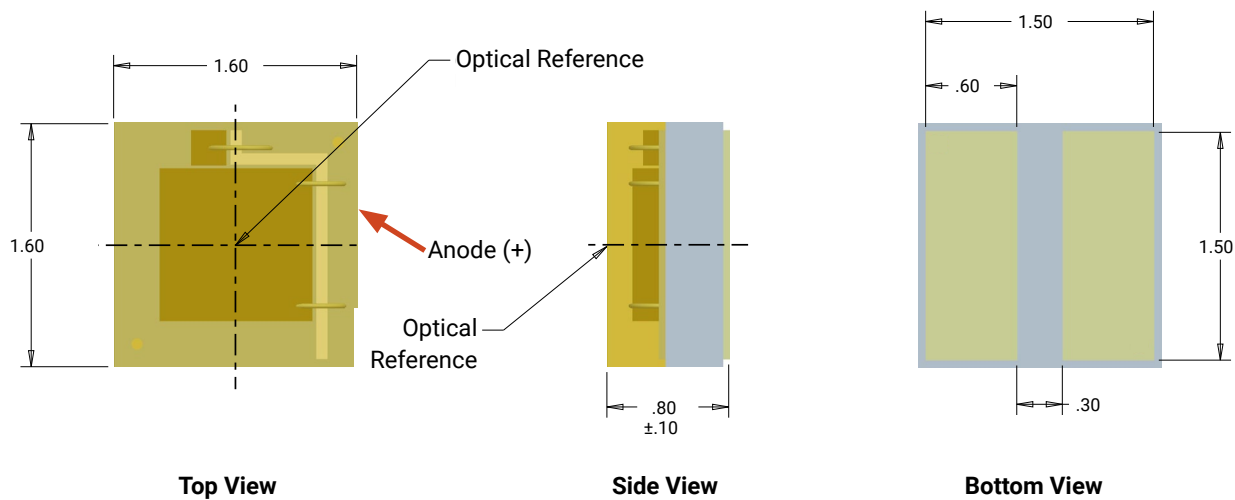

**MECHANICAL DIMENSIONS - CONTINUED**

**High Density & High Intensity**

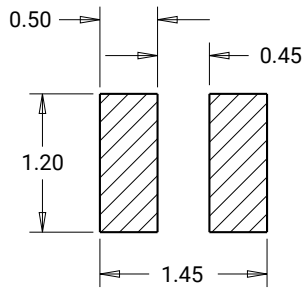

**Recommended Stencil Pad**

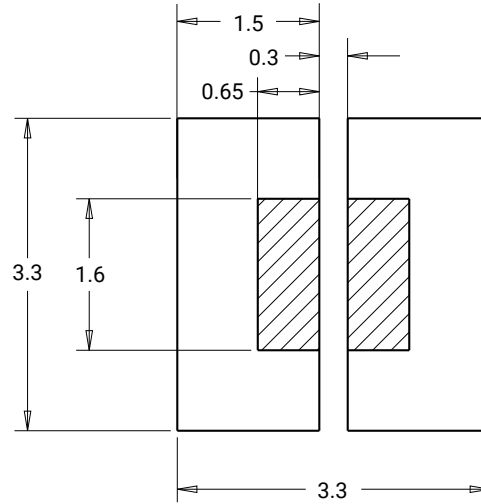

**Recommended PC Board Solder Pad and Trace Layout**

**TAPE AND REEL**

All Cree carrier tapes conform to EIA-481D, Automated Component Handling Systems Standard.

Except as noted, all dimensions in mm [in].

Measurement tolerances unless indicated otherwise: .xx = ±.10 mm

**High Density**

XQEAWT-0x-xxxx-xxxxxxxxx  
 ↑  
 XQ-E High Density

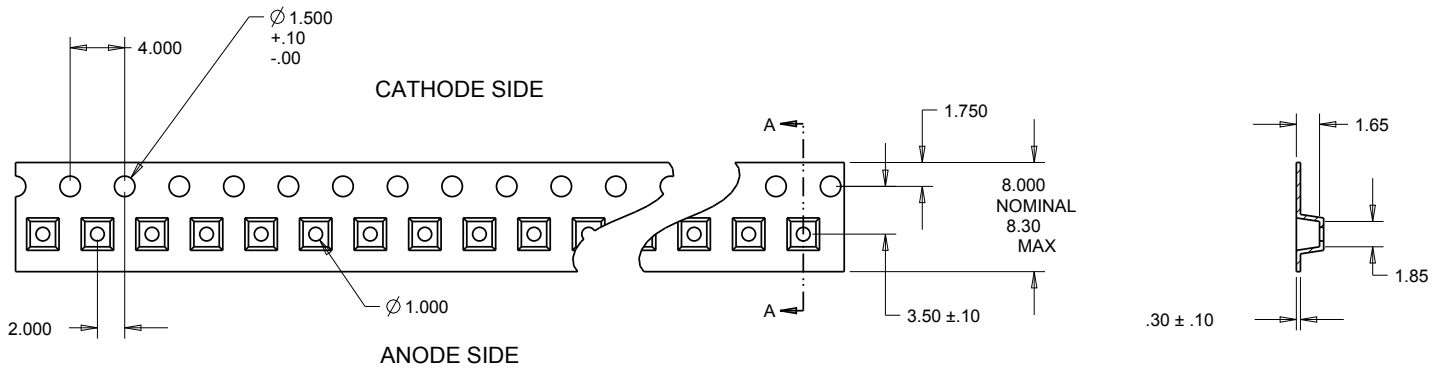

**High Intensity**

XQEAWT-Hx-xxxx-xxxxxxxxx  
 ↑  
 XQ-E High Intensity

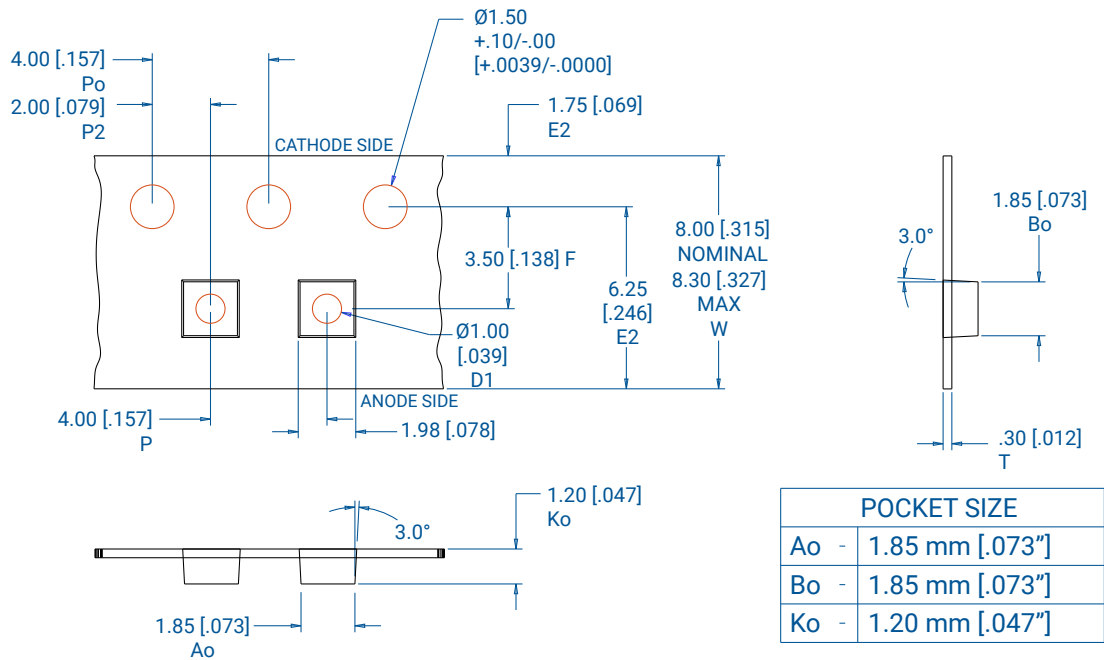

**TAPE AND REEL - CONTINUED**

**High Density & High Intensity**

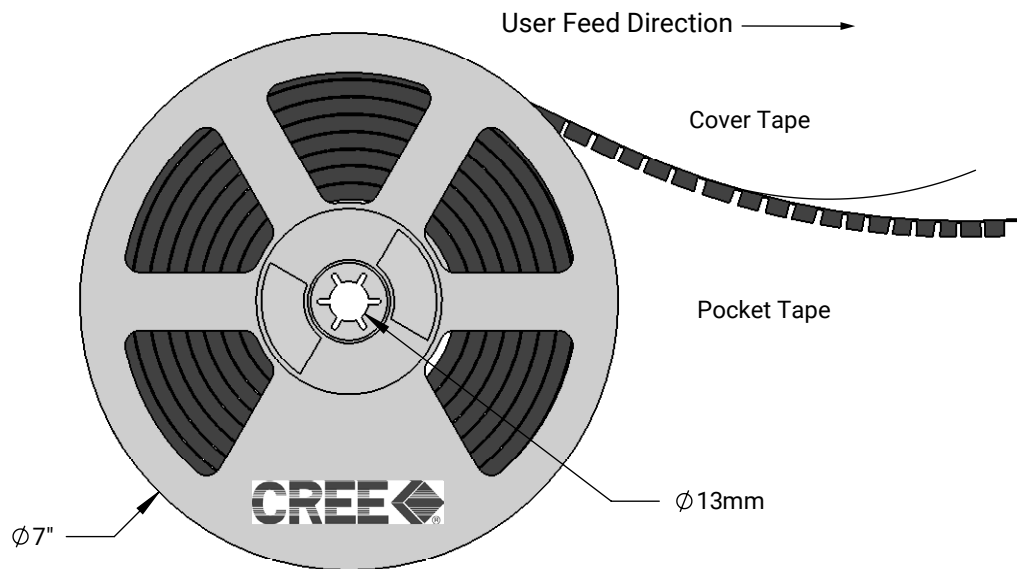
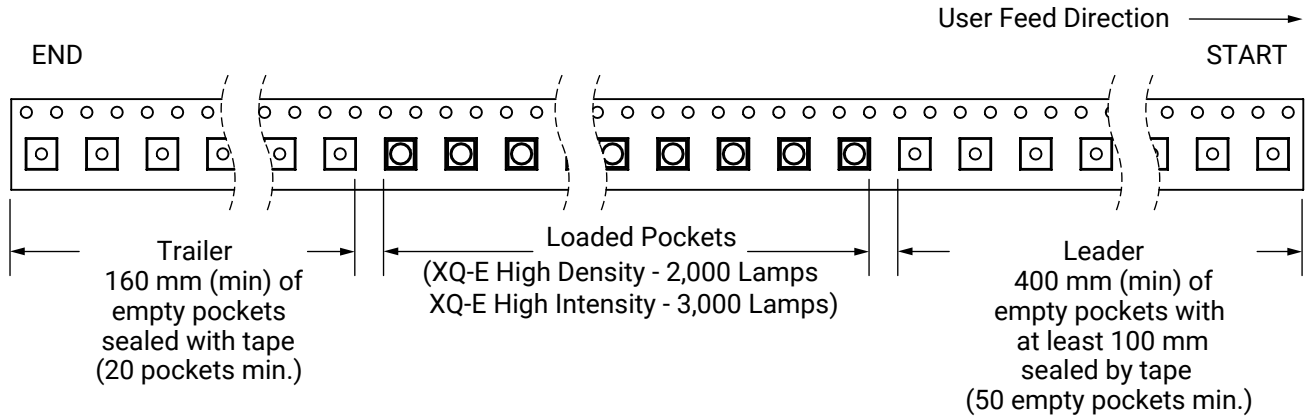

**PACKAGING**

The diagrams below show the packaging and labels Cree uses to ship XLamp XQ-E LEDs. XLamp XQ-E LEDs are shipped in tape loaded on a reel. Each box contains only one reel in a moisture barrier bag.

**Unpackaged Reel**

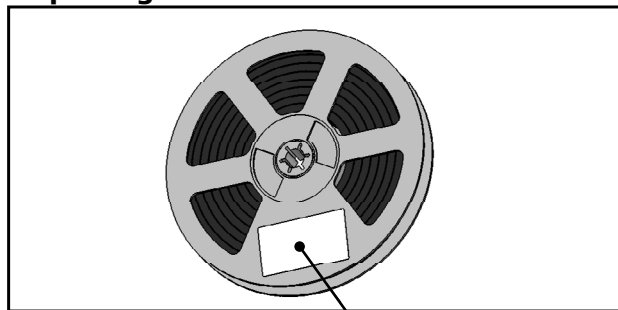

Label with Cree Bin Code, Quantity, Reel ID

**Packaged Reel**



Label with Cree Order Code, Quantity, Reel ID, PO #

Label with Cree Bin Code, Quantity, Reel ID

**Boxed Reel**



Label with Cree Order Code, Quantity, Reel ID, PO #

Label with Cree Bin Code, Quantity, Reel ID

Patent Label (on bottom of box)