

# Cree® XLamp® XP-E High-Efficiency White LEDs



## PRODUCT DESCRIPTION

XLamp® XP-E High-Efficiency White (HEW) LEDs upgrade the XLamp XP-E LED to leading performance levels for diffuse lighting applications. The XP-E HEW is designed to enable faster adoption of LED light in cost-sensitive, consumer lighting products. Compared to the standard XLamp XP-E LED, the XP-E HEW can reduce LED count by 50% and still deliver the same system performance.

Cree XLamp LEDs bring high performance and quality of light to a wide range of lighting applications, including color-changing, portable and personal, outdoor, indoor-directional, transportation, stage and studio, commercial and emergency-vehicle lighting.

## FEATURES

- Light output and efficacy similar to XLamp XP-G LED
- Maximum drive current: 1000 mA
- Low thermal resistance: 6 °C/W
- Maximum junction temperature: 150 °C
- Wide viewing angle: 120°
- Reflow solderable - JEDEC J-STD-020C compatible
- Electrically neutral thermal path
- RoHS and REACH compliant
- UL® recognized component (E349212)

## TABLE OF CONTENTS

|   |    |
|---|----|
| Characteristics .....   | 2  |
| Flux Characteristics .....  | 3  |
| Relative Spectral Power Distribution ...  | 5  |
| Relative Flux vs. Junction Temperature .....  | 6  |
| Electrical Characteristics .....  | 6  |
| Relative Flux vs. Current .....   | 7  |
| Relative Chromaticity vs. Current .....   | 7  |
| Relative Chromaticity vs. Temperature   | 8  |
| Typical Spatial Distribution .....  | 8  |
| Thermal Design .....  | 9  |
| Performance Groups - Luminous Flux  | 9  |
| Performance Groups - Chromaticity ..  | 10 |
| Performance Groups - Forward Voltage .....  | 12 |
| Cree's Standard Chromaticity Regions Plotted on the 1931 CIE Curve .....                        | 13 |
| Cree's Standard Cool White Kits Plotted on ANSI Standard Chromaticity Regions .....             | 14 |
| Cree's Standard Warm and Neutral White Kits Plotted on ANSI Standard Chromaticity Regions ..... | 15 |
| Cree's Standard Chromaticity Kits .....   | 16 |
| Bin and Order Code Formats .....  | 16 |
| Reflow Soldering Characteristics .....  | 17 |
| Notes .....   | 18 |
| Mechanical Dimensions .....   | 20 |
| Tape and Reel .....   | 21 |
| Packaging .....   | 22 |



## CHARACTERISTICS

| Characteristics                                      | Unit    | Minimum | Typical | Maximum |
|--|---------|---------|---------|---------|
| Thermal resistance, junction to solder point - white | °C/W    |         | 6       |         |
| Viewing angle (FWHM) - white                         | degrees |         | 120     |         |
| Temperature coefficient of voltage - white           | mV/°C   |         | -3      |         |
| ESD classification (HBM per Mil-Std-883D)            |         |         | Class 2 |         |
| DC forward current - white                           | mA      |         |         | 1000    |
| Reverse voltage                                      | V       |         |         | 5       |
| Forward voltage (@ 350 mA) - white                   | V       |         | 3.0     | 3.5     |
| Forward voltage (@ 700 mA) - white                   | V       |         | 3.15    |         |
| Forward voltage (@ 1000 mA) - white                  | V       |         | 3.25    |         |
| LED junction temperature                             | °C      |         |         | 150     |

**FLUX CHARACTERISTICS (T<sub>J</sub> = 25 °C)**

The following tables provide order codes for XLamp XP-E HEW LEDs. For a complete description of the order code nomenclature, please see the Bin and Order Code Formats section (page 16). For definitions of the chromaticity kits, please see the Cree's Standard Chromaticity Kits section (page 16).

| Chromaticity |        | Minimum Luminous Flux (lm) @ 350 mA |           | Order Codes          |
|--------------|--------|-------------------------------------|-----------|----------------------|
| Kit          | CCT    | Code                                | Flux (lm) | 68 CRI Typical       |
| 51           | 6200 K | R5                                  | 139       | XPEHEW-L1-0000-00H51 |
|              |        | R4                                  | 130       | XPEHEW-L1-0000-00G51 |
|              |        | R3                                  | 122       | XPEHEW-L1-0000-00F51 |
| 53           | 6000 K | R5                                  | 139       | XPEHEW-L1-0000-00H53 |
|              |        | R4                                  | 130       | XPEHEW-L1-0000-00G53 |
|              |        | R3                                  | 122       | XPEHEW-L1-0000-00F53 |
| 50           | 6200 K | R3                                  | 122       | XPEHEW-L1-0000-00F50 |

| Chromaticity |        | Minimum Luminous Flux (lm) @ 350 mA |           | Order Codes          |                      |                      |
|--------------|--------|-------------------------------------|-----------|----------------------|----------------------|----------------------|
| Kit          | CCT    | Code                                | Flux (lm) | 70 CRI Typical       | 75 CRI Typical       | 80 CRI Minimum       |
| E3           | 5000 K | R4                                  | 130       | XPEHEW-01-0000-00GE3 |                      |                      |
|              |        | R3                                  | 122       | XPEHEW-01-0000-00FE3 | XPEHEW-L1-0000-00FE3 |                      |
|              |        | R2                                  | 114       | XPEHEW-01-0000-00EE3 | XPEHEW-L1-0000-00EE3 |                      |
|              |        | Q5                                  | 107       |                      | XPEHEW-L1-0000-00DE3 |                      |
| F4           | 4750 K | R4                                  | 130       | XPEHEW-01-0000-00GF4 |                      |                      |
|              |        | R3                                  | 122       | XPEHEW-01-0000-00FF4 | XPEHEW-L1-0000-00FF4 |                      |
|              |        | R2                                  | 114       | XPEHEW-01-0000-00EF4 | XPEHEW-L1-0000-00EF4 |                      |
|              |        | Q5                                  | 107       |                      | XPEHEW-L1-0000-00DF4 |                      |
| E4           | 4500 K | R4                                  | 130       | XPEHEW-01-0000-00GE4 |                      |                      |
|              |        | R3                                  | 122       | XPEHEW-01-0000-00FE4 | XPEHEW-L1-0000-00FE4 |                      |
|              |        | R2                                  | 114       | XPEHEW-01-0000-00EE4 | XPEHEW-L1-0000-00EE4 |                      |
|              |        | Q5                                  | 107       |                      | XPEHEW-L1-0000-00DE4 |                      |
| F5           | 4250 K | R4                                  | 130       | XPEHEW-01-0000-00GF5 |                      |                      |
|              |        | R3                                  | 122       | XPEHEW-01-0000-00FF5 | XPEHEW-L1-0000-00FF5 |                      |
|              |        | R2                                  | 114       | XPEHEW-01-0000-00EF5 | XPEHEW-L1-0000-00EF5 |                      |
|              |        | Q5                                  | 107       |                      | XPEHEW-L1-0000-00DF5 |                      |
| E5           | 4000 K | R4                                  | 130       | XPEHEW-01-0000-00GE5 |                      |                      |
|              |        | R3                                  | 122       | XPEHEW-01-0000-00FE5 | XPEHEW-L1-0000-00FE5 |                      |
|              |        | R2                                  | 114       | XPEHEW-01-0000-00EE5 | XPEHEW-L1-0000-00EE5 | XPEHEW-H1-0000-00EE5 |
|              |        | Q5                                  | 107       |                      | XPEHEW-L1-0000-00DE5 | XPEHEW-H1-0000-00DE5 |

**Notes:**

- Cree maintains a tolerance of ±7% on flux and power measurements, ±0.005 on chromaticity (CCx, CCy) measurements and a tolerance of ±2 on CRI measurements. See the Measurements section (page 18).
- Cree XLamp XP-E HEW LED order codes specify only a minimum flux bin and not a maximum. Cree may ship reels in flux bins higher than the minimum specified by the order code without advance notice. Shipments will always adhere to the chromaticity bin restrictions specified by the order code.

FLUX CHARACTERISTICS (T<sub>j</sub> = 25 °C) - CONTINUED

| Chromaticity |        | Minimum Luminous Flux (lm) @ 350 mA |           | Order Codes          |                      |                      |                      |                      |
|--------------|--------|-------------------------------------|-----------|----------------------|----------------------|----------------------|----------------------|----------------------|
| Kit          | CCT    | Code                                | Flux (lm) | 70 CRI Typical       | 80 CRI Typical       | 80 CRI Minimum       | 85 CRI Minimum       | 90 CRI Minimum       |
| F6           | 3750 K | R2                                  | 114       | XPEHEW-01-0000-00EF6 | XPEHEW-L1-0000-00EF6 | XPEHEW-H1-0000-00EF6 |                      |                      |
|              |        | Q5                                  | 107       | XPEHEW-01-0000-00DF6 | XPEHEW-L1-0000-00DF6 | XPEHEW-H1-0000-00DF6 |                      |                      |
|              |        | Q4                                  | 100       |                      | XPEHEW-L1-0000-00CF6 | XPEHEW-H1-0000-00CF6 |                      |                      |
| E6           | 3500 K | R2                                  | 114       | XPEHEW-01-0000-00EE6 | XPEHEW-L1-0000-00EE6 |                      |                      |                      |
|              |        | Q5                                  | 107       | XPEHEW-01-0000-00DE6 | XPEHEW-L1-0000-00DE6 | XPEHEW-H1-0000-00DE6 |                      |                      |
|              |        | Q4                                  | 100       |                      | XPEHEW-L1-0000-00CE6 | XPEHEW-H1-0000-00CE6 |                      |                      |
| F7           | 3250 K | R2                                  | 114       | XPEHEW-01-0000-00EF7 |                      |                      |                      |                      |
|              |        | Q5                                  | 107       | XPEHEW-01-0000-00DF7 | XPEHEW-L1-0000-00DF7 | XPEHEW-H1-0000-00DF7 |                      |                      |
|              |        | Q4                                  | 100       | XPEHEW-01-0000-00CF7 | XPEHEW-L1-0000-00CF7 | XPEHEW-H1-0000-00CF7 |                      |                      |
|              |        | Q3                                  | 93.9      |                      | XPEHEW-L1-0000-00BF7 | XPEHEW-H1-0000-00BF7 |                      |                      |
|              |        | P3                                  | 73.9      |                      |                      |                      |                      |                      |
| E7           | 3000 K | R2                                  | 114       | XPEHEW-01-0000-00EE7 |                      |                      |                      |                      |
|              |        | Q5                                  | 107       | XPEHEW-01-0000-00DE7 | XPEHEW-L1-0000-00DE7 |                      |                      |                      |
|              |        | Q4                                  | 100       | XPEHEW-01-0000-00CE7 | XPEHEW-L1-0000-00CE7 | XPEHEW-H1-0000-00CE7 |                      |                      |
|              |        | Q3                                  | 93.9      |                      | XPEHEW-L1-0000-00BE7 | XPEHEW-H1-0000-00BE7 | XPEHEW-P1-0000-00BE7 |                      |
|              |        | Q2                                  | 87.4      |                      |                      |                      | XPEHEW-P1-0000-00AE7 | XPEHEW-U1-0000-00AE7 |
|              |        | P4                                  | 80.6      |                      |                      |                      | XPEHEW-P1-0000-009E7 | XPEHEW-U1-0000-009E7 |
| F8           | 2850 K | Q5                                  | 107       | XPEHEW-01-0000-00DF8 |                      |                      |                      |                      |
|              |        | Q4                                  | 100       | XPEHEW-01-0000-00CF8 | XPEHEW-L1-0000-00CF8 | XPEHEW-H1-0000-00CF8 |                      |                      |
|              |        | Q3                                  | 93.9      |                      | XPEHEW-L1-0000-00BF8 | XPEHEW-H1-0000-00BF8 |                      |                      |
|              |        | Q2                                  | 87.4      |                      | XPEHEW-L1-0000-00AF8 | XPEHEW-H1-0000-00AF8 | XPEHEW-P1-0000-00AF8 | XPEHEW-U1-0000-00AF8 |
|              |        | P4                                  | 80.6      |                      |                      |                      | XPEHEW-P1-0000-009F8 | XPEHEW-U1-0000-009F8 |
|              |        | P3                                  | 73.9      |                      |                      |                      | XPEHEW-P1-0000-008F8 | XPEHEW-U1-0000-008F8 |
| E8           | 2700 K | Q5                                  | 107       | XPEHEW-01-0000-00DE8 |                      |                      |                      |                      |
|              |        | Q4                                  | 100       | XPEHEW-01-0000-00CE8 | XPEHEW-L1-0000-00CE8 |                      |                      |                      |
|              |        | Q3                                  | 93.9      |                      | XPEHEW-L1-0000-00BE8 | XPEHEW-H1-0000-00BE8 |                      |                      |
|              |        | Q2                                  | 87.4      |                      | XPEHEW-L1-0000-00AE8 | XPEHEW-H1-0000-00AE8 | XPEHEW-P1-0000-00AE8 |                      |
|              |        | P4                                  | 80.6      |                      |                      |                      | XPEHEW-P1-0000-009E8 | XPEHEW-U1-0000-009E8 |
|              |        | P3                                  | 73.9      |                      |                      |                      | XPEHEW-P1-0000-008E8 | XPEHEW-U1-0000-008E8 |

## Notes:

- Cree maintains a tolerance of ±7% on flux and power measurements, ±0.005 on chromaticity (CCx, CCy) measurements and a tolerance of ±2 on CRI measurements. See the Measurements section (page 18).
- Cree XLamp XP-E HEW LED order codes specify only a minimum flux bin and not a maximum. Cree may ship reels in flux bins higher than the minimum specified by the order code without advance notice. Shipments will always adhere to the chromaticity bin restrictions specified by the order code.

**RELATIVE SPECTRAL POWER DISTRIBUTION**

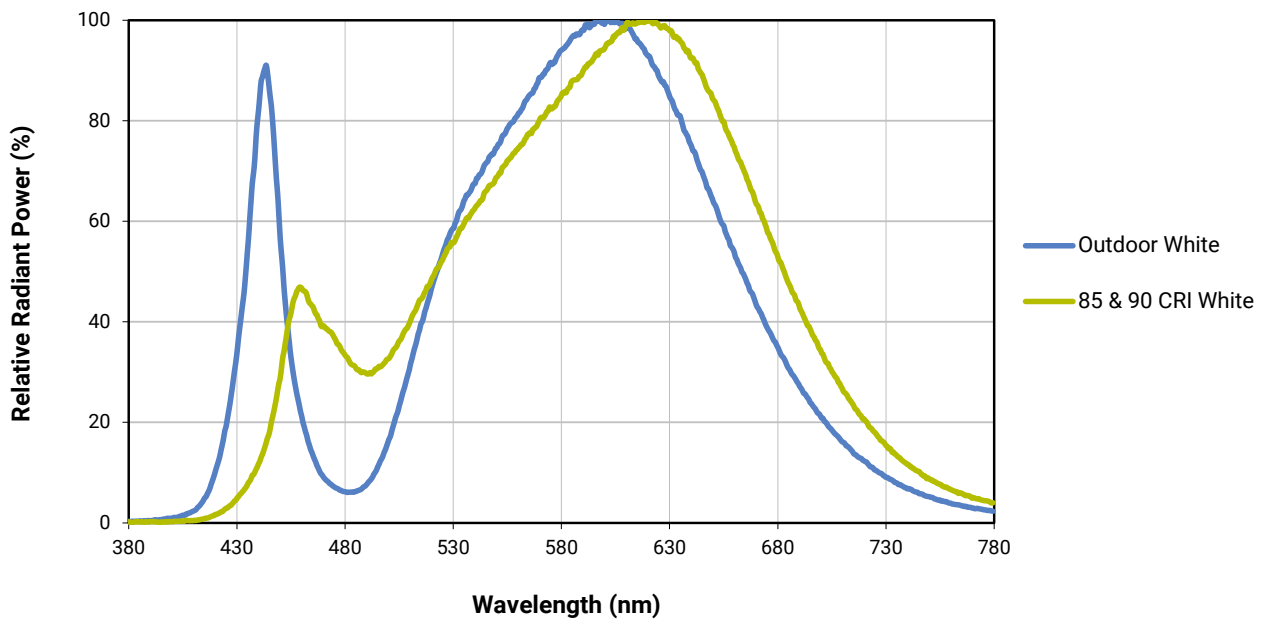
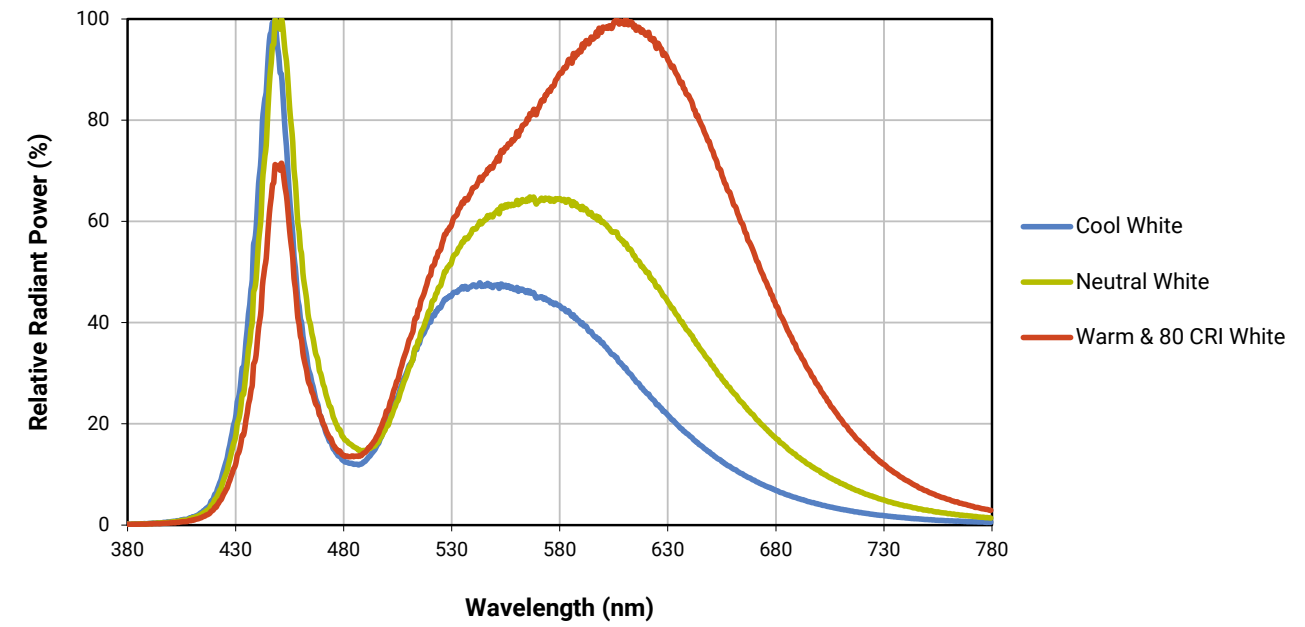

**RELATIVE FLUX VS. JUNCTION TEMPERATURE ( $I_F = 350 \text{ mA}$ )**

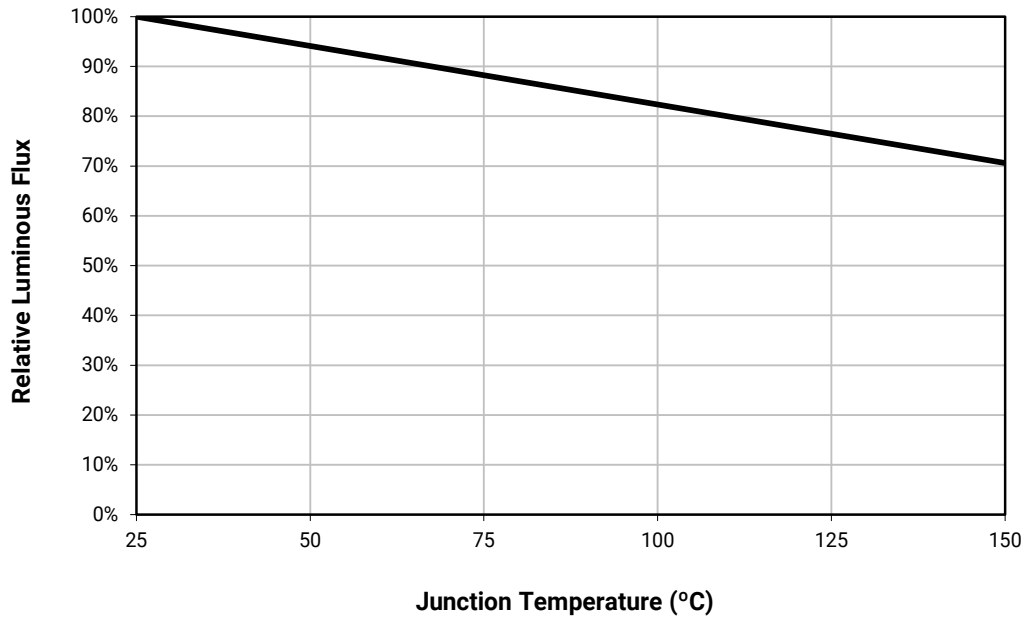

**ELECTRICAL CHARACTERISTICS ( $T_J = 25 \text{ °C}$ )**

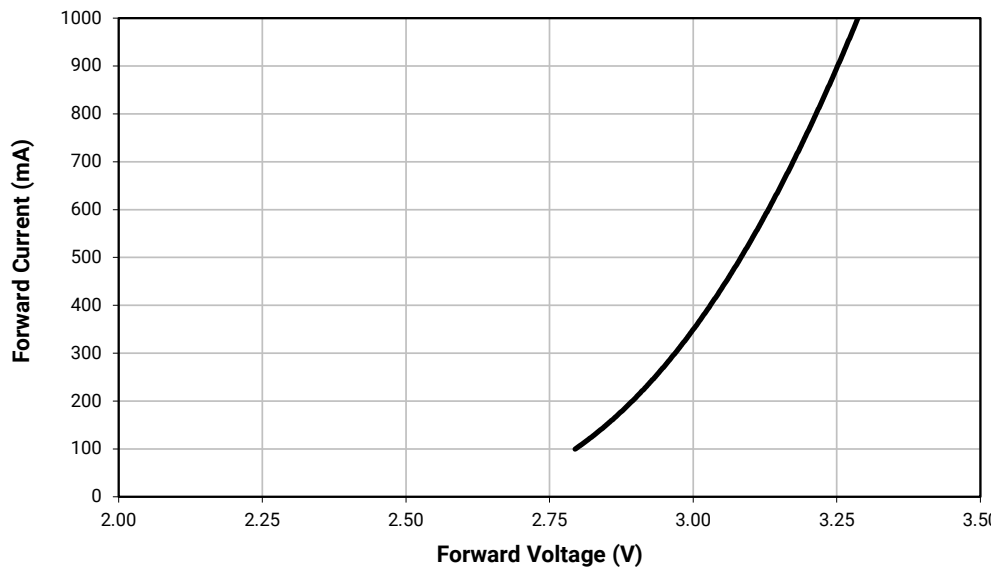

**RELATIVE FLUX VS. CURRENT ( $T_j = 25\text{ }^\circ\text{C}$ )**

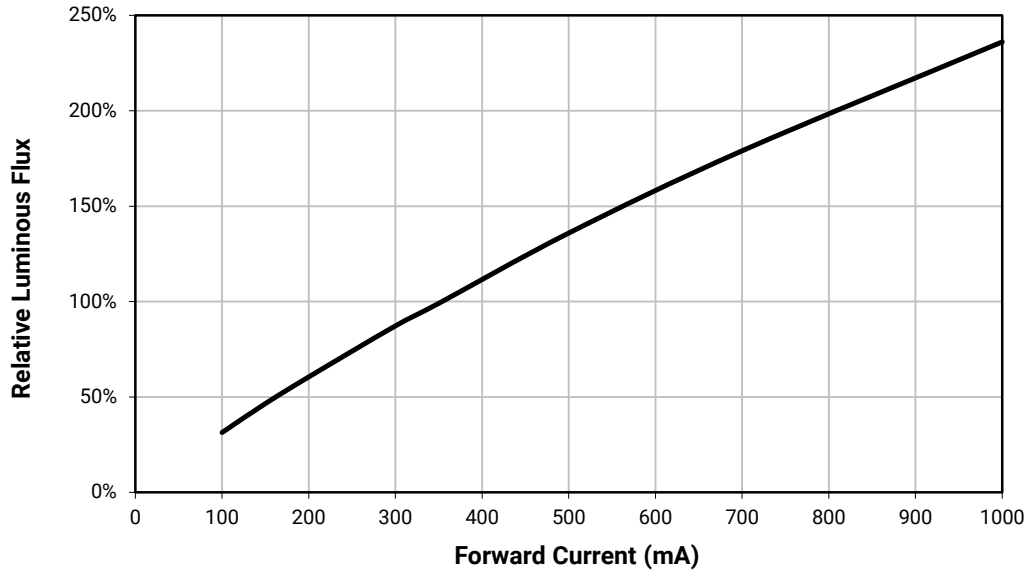

**RELATIVE CHROMATICITY VS. CURRENT - WARM WHITE**

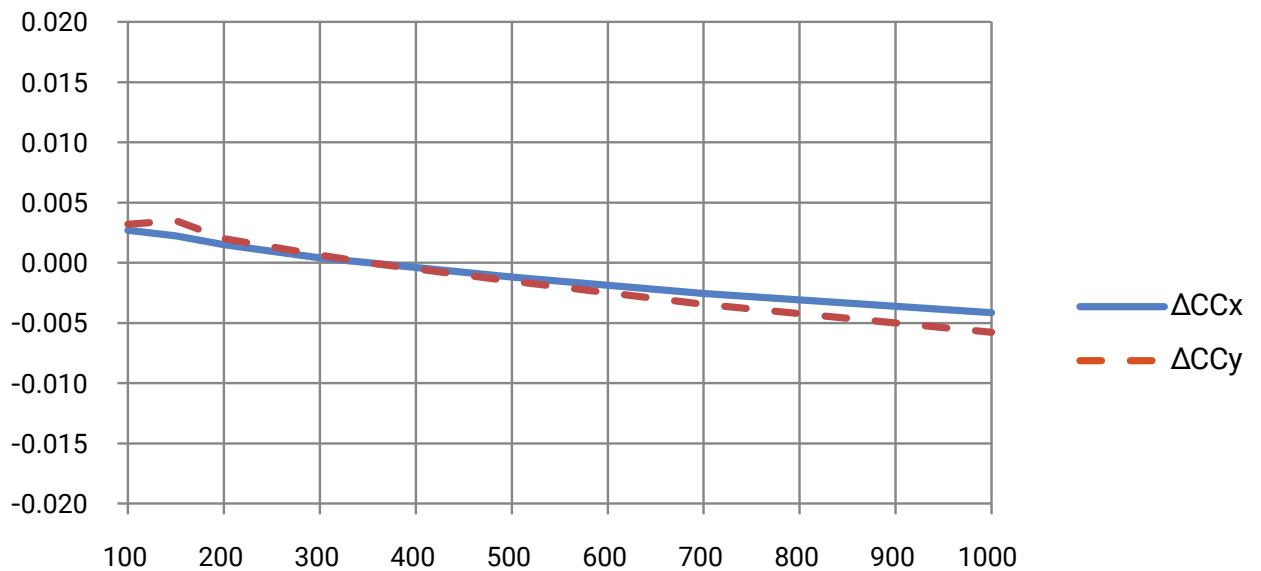

**RELATIVE CHROMATICITY VS. TEMPERATURE - WARM WHITE**

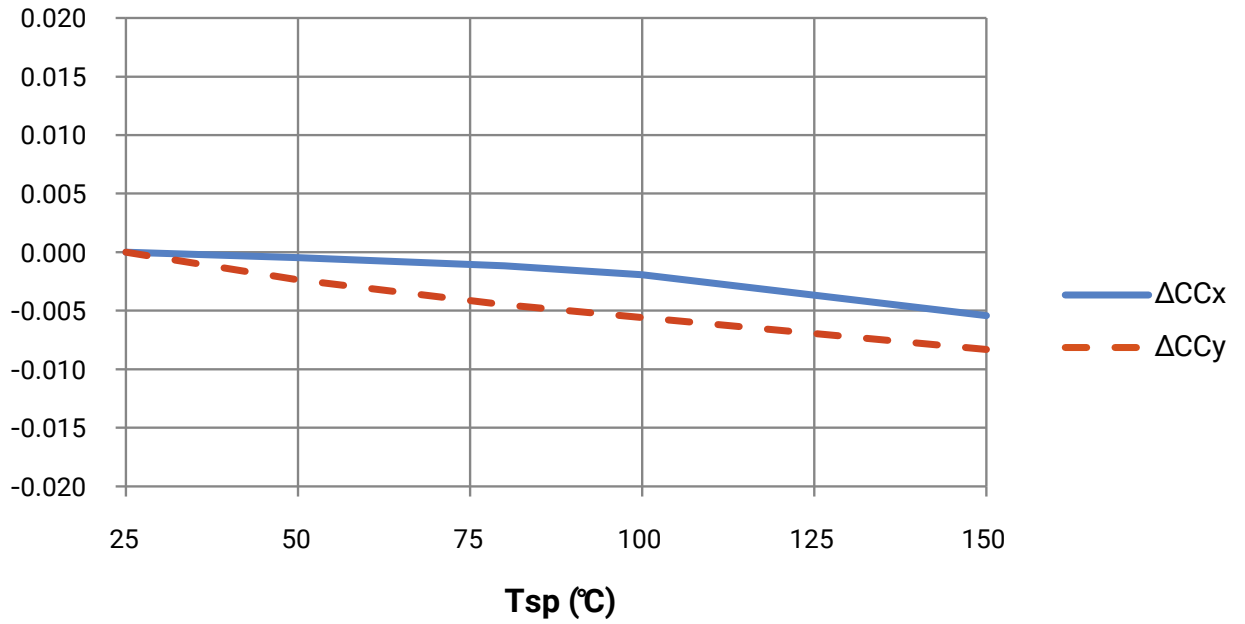

**TYPICAL SPATIAL DISTRIBUTION**

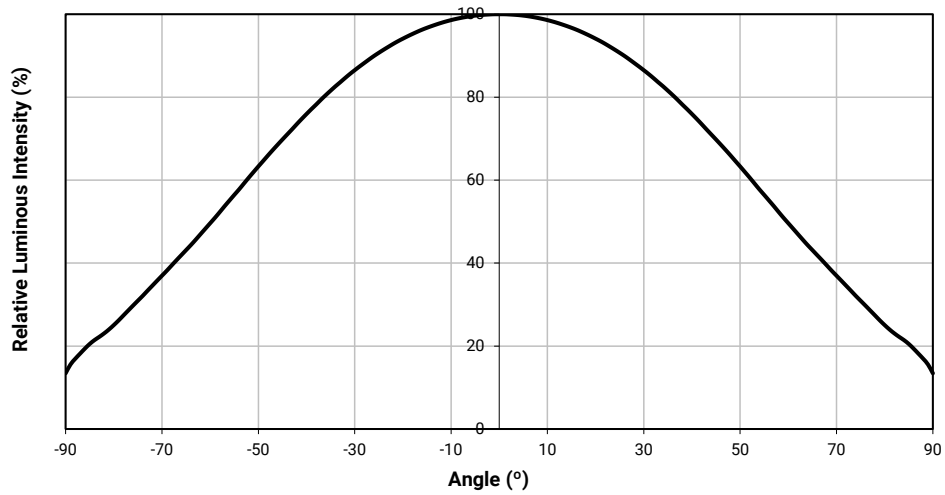



**THERMAL DESIGN**

The maximum forward current is determined by the thermal resistance between the LED junction and ambient. It is crucial for the end product to be designed in a manner that minimizes the thermal resistance from the solder point to ambient in order to optimize lamp life and optical characteristics.

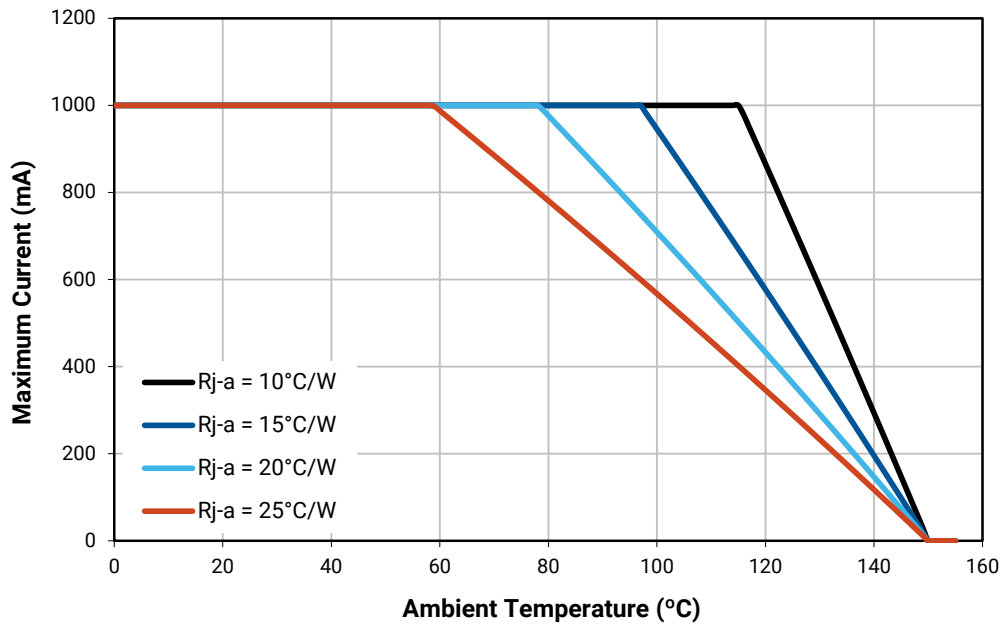

**PERFORMANCE GROUPS - LUMINOUS FLUX**

XLamp XP-E HEW LEDs are tested for luminous flux and placed into one of the following luminous-flux groups:

| Group Code | Minimum Luminous Flux (lm) @ 350 mA | Maximum Luminous Flux (lm) @ 350 mA |
|------------|-------------------------------------|-------------------------------------|
| P3         | 73.9                                | 80.6                                |
| P4         | 80.6                                | 87.4                                |
| Q2         | 87.4                                | 93.9                                |
| Q3         | 93.9                                | 100                                 |
| Q4         | 100                                 | 107                                 |
| Q5         | 107                                 | 114                                 |
| R2         | 114                                 | 122                                 |
| R3         | 122                                 | 130                                 |
| R4         | 130                                 | 139                                 |
| R5         | 139                                 | 148                                 |
| S2         | 148                                 | 156                                 |
| S3         | 156                                 | 164                                 |
| S4         | 164                                 | 172                                 |

**PERFORMANCE GROUPS - CHROMATICITY**

White XLamp LEDs are tested for chromaticity and placed into one of the regions defined by the bounding coordinates on the following pages.

| Region | x      | y      | Region | x      | y      | Region | x      | y      | Region | x      | y      |
|--------|--------|--------|--------|--------|--------|--------|--------|--------|--------|--------|--------|
| 0A     | 0.2950 | 0.2970 | 0B     | 0.2920 | 0.3060 | 0C     | 0.2984 | 0.3133 | 0D     | 0.2984 | 0.3133 |
|        | 0.2920 | 0.3060 |        | 0.2895 | 0.3135 |        | 0.2962 | 0.3220 |        | 0.3048 | 0.3207 |
|        | 0.2984 | 0.3133 |        | 0.2962 | 0.3220 |        | 0.3028 | 0.3304 |        | 0.3068 | 0.3113 |
|        | 0.3009 | 0.3042 |        | 0.2984 | 0.3133 |        | 0.3048 | 0.3207 |        | 0.3009 | 0.3042 |
| 0R     | 0.2980 | 0.2880 | 0S     | 0.2895 | 0.3135 | 0T     | 0.2962 | 0.3220 | 0U     | 0.3037 | 0.2937 |
|        | 0.2950 | 0.2970 |        | 0.2870 | 0.3210 |        | 0.2937 | 0.3312 |        | 0.3009 | 0.3042 |
|        | 0.3009 | 0.3042 |        | 0.2937 | 0.3312 |        | 0.3005 | 0.3415 |        | 0.3068 | 0.3113 |
|        | 0.3037 | 0.2937 |        | 0.2962 | 0.3220 |        | 0.3028 | 0.3304 |        | 0.3093 | 0.2993 |
| 1A     | 0.3048 | 0.3207 | 1B     | 0.3028 | 0.3304 | 1C     | 0.3115 | 0.3391 | 1D     | 0.3130 | 0.3290 |
|        | 0.3130 | 0.3290 |        | 0.3115 | 0.3391 |        | 0.3205 | 0.3481 |        | 0.3213 | 0.3373 |
|        | 0.3144 | 0.3186 |        | 0.3130 | 0.3290 |        | 0.3213 | 0.3373 |        | 0.3221 | 0.3261 |
|        | 0.3068 | 0.3113 |        | 0.3048 | 0.3207 |        | 0.3130 | 0.3290 |        | 0.3144 | 0.3186 |
| 1R     | 0.3068 | 0.3113 | 1S     | 0.3005 | 0.3415 | 1T     | 0.3099 | 0.3509 | 1U     | 0.3144 | 0.3186 |
|        | 0.3144 | 0.3186 |        | 0.3099 | 0.3509 |        | 0.3196 | 0.3602 |        | 0.3221 | 0.3261 |
|        | 0.3161 | 0.3059 |        | 0.3115 | 0.3391 |        | 0.3205 | 0.3481 |        | 0.3231 | 0.3120 |
|        | 0.3093 | 0.2993 |        | 0.3028 | 0.3304 |        | 0.3115 | 0.3391 |        | 0.3161 | 0.3059 |
| 2A     | 0.3215 | 0.3350 | 2B     | 0.3207 | 0.3462 | 2C     | 0.3290 | 0.3538 | 2D     | 0.3290 | 0.3417 |
|        | 0.3290 | 0.3417 |        | 0.3290 | 0.3538 |        | 0.3376 | 0.3616 |        | 0.3371 | 0.3490 |
|        | 0.3290 | 0.3300 |        | 0.3290 | 0.3417 |        | 0.3371 | 0.3490 |        | 0.3366 | 0.3369 |
|        | 0.3222 | 0.3243 |        | 0.3215 | 0.3350 |        | 0.3290 | 0.3417 |        | 0.3290 | 0.3300 |
| 2R     | 0.3222 | 0.3243 | 2S     | 0.3196 | 0.3602 | 2T     | 0.3290 | 0.3690 | 2U     | 0.3290 | 0.3300 |
|        | 0.3290 | 0.3300 |        | 0.3290 | 0.3690 |        | 0.3381 | 0.3762 |        | 0.3366 | 0.3369 |
|        | 0.3290 | 0.3180 |        | 0.3290 | 0.3538 |        | 0.3376 | 0.3616 |        | 0.3361 | 0.3245 |
|        | 0.3231 | 0.3120 |        | 0.3207 | 0.3462 |        | 0.3290 | 0.3538 |        | 0.3290 | 0.3180 |
| 3A     | 0.3371 | 0.3490 | 3B     | 0.3376 | 0.3616 | 3C     | 0.3463 | 0.3687 | 3D     | 0.3451 | 0.3554 |
|        | 0.3451 | 0.3554 |        | 0.3463 | 0.3687 |        | 0.3551 | 0.3760 |        | 0.3533 | 0.3620 |
|        | 0.3440 | 0.3427 |        | 0.3451 | 0.3554 |        | 0.3533 | 0.3620 |        | 0.3515 | 0.3487 |
|        | 0.3366 | 0.3369 |        | 0.3371 | 0.3490 |        | 0.3451 | 0.3554 |        | 0.3440 | 0.3427 |
| 3R     | 0.3366 | 0.3369 | 3S     | 0.3381 | 0.3762 |        |        |        |        |        |        |
|        | 0.3440 | 0.3428 |        | 0.3480 | 0.3840 |        |        |        |        |        |        |
|        | 0.3429 | 0.3307 |        | 0.3463 | 0.3687 |        |        |        |        |        |        |
|        | 0.3361 | 0.3245 |        | 0.3376 | 0.3616 |        |        |        |        |        |        |
| 4A     | 0.3530 | 0.3597 | 4B     | 0.3548 | 0.3736 | 4C     | 0.3641 | 0.3804 | 4D     | 0.3615 | 0.3659 |
|        | 0.3615 | 0.3659 |        | 0.3641 | 0.3804 |        | 0.3736 | 0.3874 |        | 0.3702 | 0.3722 |
|        | 0.3590 | 0.3521 |        | 0.3615 | 0.3659 |        | 0.3702 | 0.3722 |        | 0.3670 | 0.3578 |
|        | 0.3512 | 0.3465 |        | 0.3530 | 0.3597 |        | 0.3615 | 0.3659 |        | 0.3590 | 0.3521 |

## PERFORMANCE GROUPS - CHROMATICITY (CONTINUED)

| Region | x      | y      | Region | x      | y      | Region | x      | y      | Region | x      | y      |
|--------|--------|--------|--------|--------|--------|--------|--------|--------|--------|--------|--------|
| 5A1    | 0.3670 | 0.3578 | 5A2    | 0.3686 | 0.3649 | 5A3    | 0.3744 | 0.3685 | 5A4    | 0.3726 | 0.3612 |
|        | 0.3686 | 0.3649 |        | 0.3702 | 0.3722 |        | 0.3763 | 0.3760 |        | 0.3744 | 0.3685 |
|        | 0.3744 | 0.3685 |        | 0.3763 | 0.3760 |        | 0.3825 | 0.3798 |        | 0.3804 | 0.3721 |
|        | 0.3726 | 0.3612 |        | 0.3744 | 0.3685 |        | 0.3804 | 0.3721 |        | 0.3783 | 0.3646 |
| 5B1    | 0.3702 | 0.3722 | 5B2    | 0.3719 | 0.3797 | 5B3    | 0.3782 | 0.3837 | 5B4    | 0.3763 | 0.3760 |
|        | 0.3719 | 0.3797 |        | 0.3736 | 0.3874 |        | 0.3802 | 0.3916 |        | 0.3782 | 0.3837 |
|        | 0.3782 | 0.3837 |        | 0.3802 | 0.3916 |        | 0.3869 | 0.3958 |        | 0.3847 | 0.3877 |
|        | 0.3763 | 0.3760 |        | 0.3782 | 0.3837 |        | 0.3847 | 0.3877 |        | 0.3825 | 0.3798 |
| 5C1    | 0.3825 | 0.3798 | 5C2    | 0.3847 | 0.3877 | 5C3    | 0.3912 | 0.3917 | 5C4    | 0.3887 | 0.3836 |
|        | 0.3847 | 0.3877 |        | 0.3869 | 0.3958 |        | 0.3937 | 0.4001 |        | 0.3912 | 0.3917 |
|        | 0.3912 | 0.3917 |        | 0.3937 | 0.4001 |        | 0.4006 | 0.4044 |        | 0.3978 | 0.3958 |
|        | 0.3887 | 0.3836 |        | 0.3912 | 0.3917 |        | 0.3978 | 0.3958 |        | 0.3950 | 0.3875 |
| 5D1    | 0.3783 | 0.3646 | 5D2    | 0.3804 | 0.3721 | 5D3    | 0.3863 | 0.3758 | 5D4    | 0.3840 | 0.3681 |
|        | 0.3804 | 0.3721 |        | 0.3825 | 0.3798 |        | 0.3887 | 0.3836 |        | 0.3863 | 0.3758 |
|        | 0.3863 | 0.3758 |        | 0.3887 | 0.3836 |        | 0.3950 | 0.3875 |        | 0.3924 | 0.3794 |
|        | 0.3840 | 0.3681 |        | 0.3863 | 0.3758 |        | 0.3924 | 0.3794 |        | 0.3898 | 0.3716 |
| 6A1    | 0.3889 | 0.3690 | 6A2    | 0.3915 | 0.3768 | 6A3    | 0.3981 | 0.3800 | 6A4    | 0.3953 | 0.3720 |
|        | 0.3915 | 0.3768 |        | 0.3941 | 0.3848 |        | 0.4010 | 0.3882 |        | 0.3981 | 0.3800 |
|        | 0.3981 | 0.3800 |        | 0.4010 | 0.3882 |        | 0.4080 | 0.3916 |        | 0.4048 | 0.3832 |
|        | 0.3953 | 0.3720 |        | 0.3981 | 0.3800 |        | 0.4048 | 0.3832 |        | 0.4017 | 0.3751 |
| 6B1    | 0.3941 | 0.3848 | 6B2    | 0.3968 | 0.3930 | 6B3    | 0.4040 | 0.3966 | 6B4    | 0.4010 | 0.3882 |
|        | 0.3968 | 0.3930 |        | 0.3996 | 0.4015 |        | 0.4071 | 0.4052 |        | 0.4040 | 0.3966 |
|        | 0.4040 | 0.3966 |        | 0.4071 | 0.4052 |        | 0.4146 | 0.4089 |        | 0.4113 | 0.4001 |
|        | 0.4010 | 0.3882 |        | 0.4040 | 0.3966 |        | 0.4113 | 0.4001 |        | 0.4080 | 0.3916 |
| 6C1    | 0.4080 | 0.3916 | 6C2    | 0.4113 | 0.4001 | 6C3    | 0.4186 | 0.4037 | 6C4    | 0.4150 | 0.3950 |
|        | 0.4113 | 0.4001 |        | 0.4146 | 0.4089 |        | 0.4222 | 0.4127 |        | 0.4186 | 0.4037 |
|        | 0.4186 | 0.4037 |        | 0.4222 | 0.4127 |        | 0.4299 | 0.4165 |        | 0.4259 | 0.4073 |
|        | 0.4150 | 0.3950 |        | 0.4186 | 0.4037 |        | 0.4259 | 0.4073 |        | 0.4221 | 0.3984 |
| 6D1    | 0.4017 | 0.3751 | 6D2    | 0.4048 | 0.3832 | 6D3    | 0.4116 | 0.3865 | 6D4    | 0.4082 | 0.3782 |
|        | 0.4048 | 0.3832 |        | 0.4080 | 0.3916 |        | 0.4150 | 0.3950 |        | 0.4116 | 0.3865 |
|        | 0.4116 | 0.3865 |        | 0.4150 | 0.3950 |        | 0.4221 | 0.3984 |        | 0.4183 | 0.3898 |
|        | 0.4082 | 0.3782 |        | 0.4116 | 0.3865 |        | 0.4183 | 0.3898 |        | 0.4147 | 0.3814 |
| 7A1    | 0.4147 | 0.3814 | 7A2    | 0.4183 | 0.3898 | 7A3    | 0.4242 | 0.3919 | 7A4    | 0.4203 | 0.3833 |
|        | 0.4183 | 0.3898 |        | 0.4221 | 0.3984 |        | 0.4281 | 0.4006 |        | 0.4242 | 0.3919 |
|        | 0.4242 | 0.3919 |        | 0.4281 | 0.4006 |        | 0.4342 | 0.4028 |        | 0.4300 | 0.3939 |
|        | 0.4203 | 0.3833 |        | 0.4242 | 0.3919 |        | 0.4300 | 0.3939 |        | 0.4259 | 0.3853 |
| 7B1    | 0.4221 | 0.3984 | 7B2    | 0.4259 | 0.4073 | 7B3    | 0.4322 | 0.4096 | 7B4    | 0.4281 | 0.4006 |
|        | 0.4259 | 0.4073 |        | 0.4299 | 0.4165 |        | 0.4364 | 0.4188 |        | 0.4322 | 0.4096 |
|        | 0.4322 | 0.4096 |        | 0.4364 | 0.4188 |        | 0.4430 | 0.4212 |        | 0.4385 | 0.4119 |
|        | 0.4281 | 0.4006 |        | 0.4322 | 0.4096 |        | 0.4385 | 0.4119 |        | 0.4342 | 0.4028 |

**PERFORMANCE GROUPS - CHROMATICITY (CONTINUED)**

| Region | x      | y      | Region | x      | y      | Region | x      | y      | Region | x      | y      |
|--------|--------|--------|--------|--------|--------|--------|--------|--------|--------|--------|--------|
| 7C1    | 0.4342 | 0.4028 | 7C2    | 0.4385 | 0.4119 | 7C3    | 0.4449 | 0.4141 | 7C4    | 0.4403 | 0.4049 |
|        | 0.4385 | 0.4119 |        | 0.4430 | 0.4212 |        | 0.4496 | 0.4236 |        | 0.4449 | 0.4141 |
|        | 0.4449 | 0.4141 |        | 0.4496 | 0.4236 |        | 0.4562 | 0.4260 |        | 0.4513 | 0.4164 |
|        | 0.4403 | 0.4049 |        | 0.4449 | 0.4141 |        | 0.4513 | 0.4164 |        | 0.4465 | 0.4071 |
| 7D1    | 0.4259 | 0.3853 | 7D2    | 0.4300 | 0.3939 | 7D3    | 0.4359 | 0.3960 | 7D4    | 0.4316 | 0.3873 |
|        | 0.4300 | 0.3939 |        | 0.4342 | 0.4028 |        | 0.4403 | 0.4049 |        | 0.4359 | 0.3960 |
|        | 0.4359 | 0.3960 |        | 0.4403 | 0.4049 |        | 0.4465 | 0.4071 |        | 0.4418 | 0.3981 |
|        | 0.4316 | 0.3873 |        | 0.4359 | 0.3960 |        | 0.4418 | 0.3981 |        | 0.4373 | 0.3893 |
| 8A1    | 0.4373 | 0.3893 | 8A2    | 0.4418 | 0.3981 | 8A3    | 0.4475 | 0.3994 | 8A4    | 0.4428 | 0.3906 |
|        | 0.4418 | 0.3981 |        | 0.4465 | 0.4071 |        | 0.4523 | 0.4085 |        | 0.4475 | 0.3994 |
|        | 0.4475 | 0.3994 |        | 0.4523 | 0.4085 |        | 0.4582 | 0.4099 |        | 0.4532 | 0.4008 |
|        | 0.4428 | 0.3906 |        | 0.4475 | 0.3994 |        | 0.4532 | 0.4008 |        | 0.4483 | 0.3919 |
| 8B1    | 0.4465 | 0.4071 | 8B2    | 0.4513 | 0.4164 | 8B3    | 0.4573 | 0.4178 | 8B4    | 0.4523 | 0.4085 |
|        | 0.4513 | 0.4164 |        | 0.4562 | 0.4260 |        | 0.4624 | 0.4274 |        | 0.4573 | 0.4178 |
|        | 0.4573 | 0.4178 |        | 0.4624 | 0.4274 |        | 0.4687 | 0.4289 |        | 0.4634 | 0.4193 |
|        | 0.4523 | 0.4085 |        | 0.4573 | 0.4178 |        | 0.4634 | 0.4193 |        | 0.4582 | 0.4099 |
| 8C1    | 0.4582 | 0.4099 | 8C2    | 0.4634 | 0.4193 | 8C3    | 0.4695 | 0.4207 | 8C4    | 0.4641 | 0.4112 |
|        | 0.4634 | 0.4193 |        | 0.4687 | 0.4289 |        | 0.4750 | 0.4304 |        | 0.4695 | 0.4207 |
|        | 0.4695 | 0.4207 |        | 0.4750 | 0.4304 |        | 0.4813 | 0.4319 |        | 0.4756 | 0.4221 |
|        | 0.4641 | 0.4112 |        | 0.4695 | 0.4207 |        | 0.4756 | 0.4221 |        | 0.4700 | 0.4126 |
| 8D1    | 0.4483 | 0.3919 | 8D2    | 0.4532 | 0.4008 | 8D3    | 0.4589 | 0.4021 | 8D4    | 0.4538 | 0.3931 |
|        | 0.4532 | 0.4008 |        | 0.4582 | 0.4099 |        | 0.4641 | 0.4112 |        | 0.4589 | 0.4021 |
|        | 0.4589 | 0.4021 |        | 0.4641 | 0.4112 |        | 0.4700 | 0.4126 |        | 0.4646 | 0.4034 |
|        | 0.4538 | 0.3931 |        | 0.4589 | 0.4021 |        | 0.4646 | 0.4034 |        | 0.4593 | 0.3944 |

**PERFORMANCE GROUPS - FORWARD VOLTAGE**

XLamp XP-E HEW LEDs are tested for forward voltage and sorted into one of the forward voltage bins defined below.

| Forward Voltage Group | Minimum Forward Voltage (V) @ 350 mA | Maximum Forward Voltage (V) @ 350 mA |
|-----------------------|--------------------------------------|--------------------------------------|
| B                     | 1.75                                 | 2.0                                  |
| C                     | 2.0                                  | 2.25                                 |
| D                     | 2.25                                 | 2.5                                  |
| E                     | 2.5                                  | 2.75                                 |
| F                     | 2.75                                 | 3.0                                  |
| G                     | 3.0                                  | 3.25                                 |
| H                     | 3.25                                 | 3.5                                  |
| J                     | 3.5                                  | 3.75                                 |

**CREE'S STANDARD CHROMATICITY REGIONS PLOTTED ON THE 1931 CIE CURVE**

**ANSI Cool White**

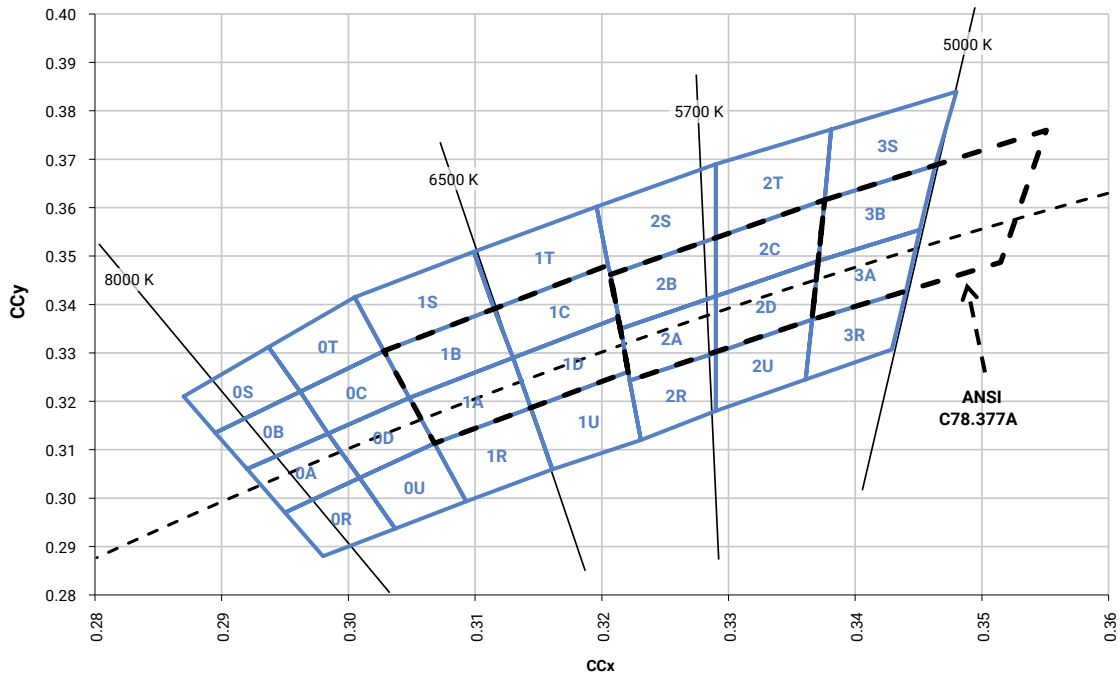

**ANSI Neutral White and ANSI Warm White**

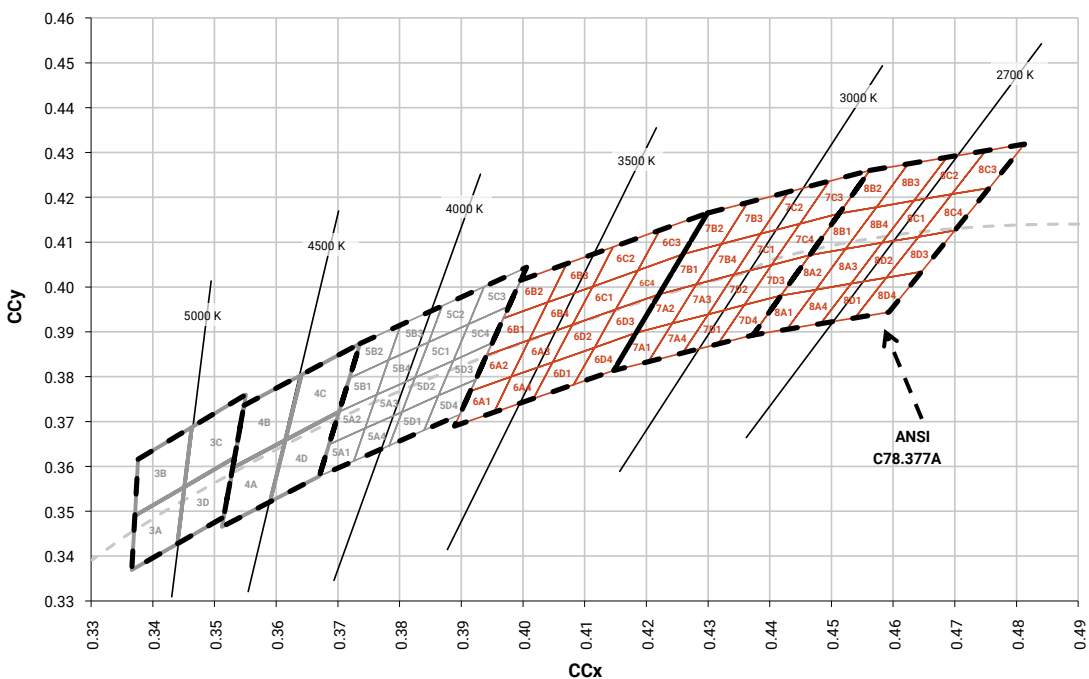

**CREE'S STANDARD COOL WHITE KITS PLOTTED ON ANSI STANDARD CHROMATICITY REGIONS**

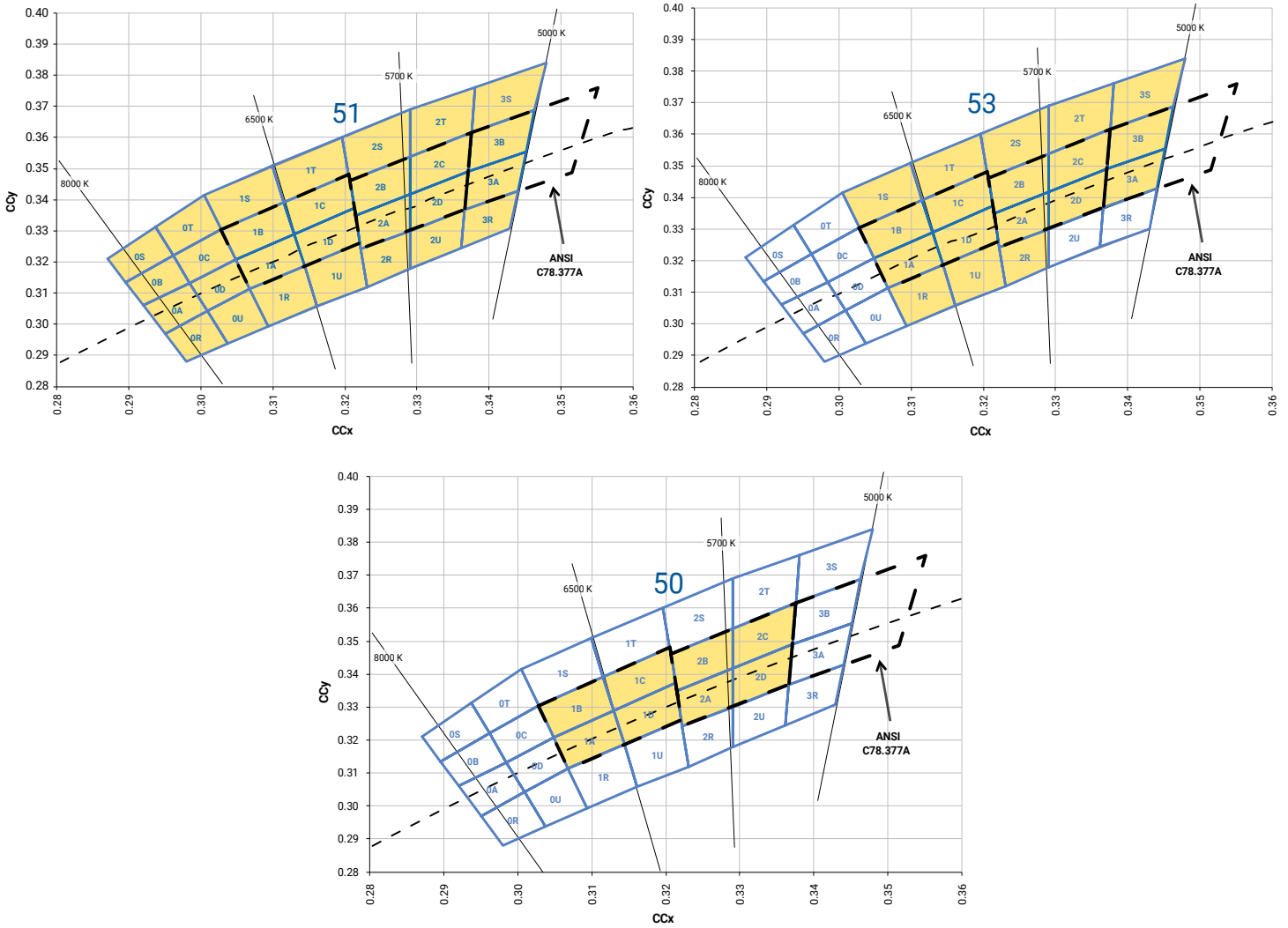

**CREE'S STANDARD WARM AND NEUTRAL WHITE KITS PLOTTED ON ANSI STANDARD CHROMATICITY REGIONS**

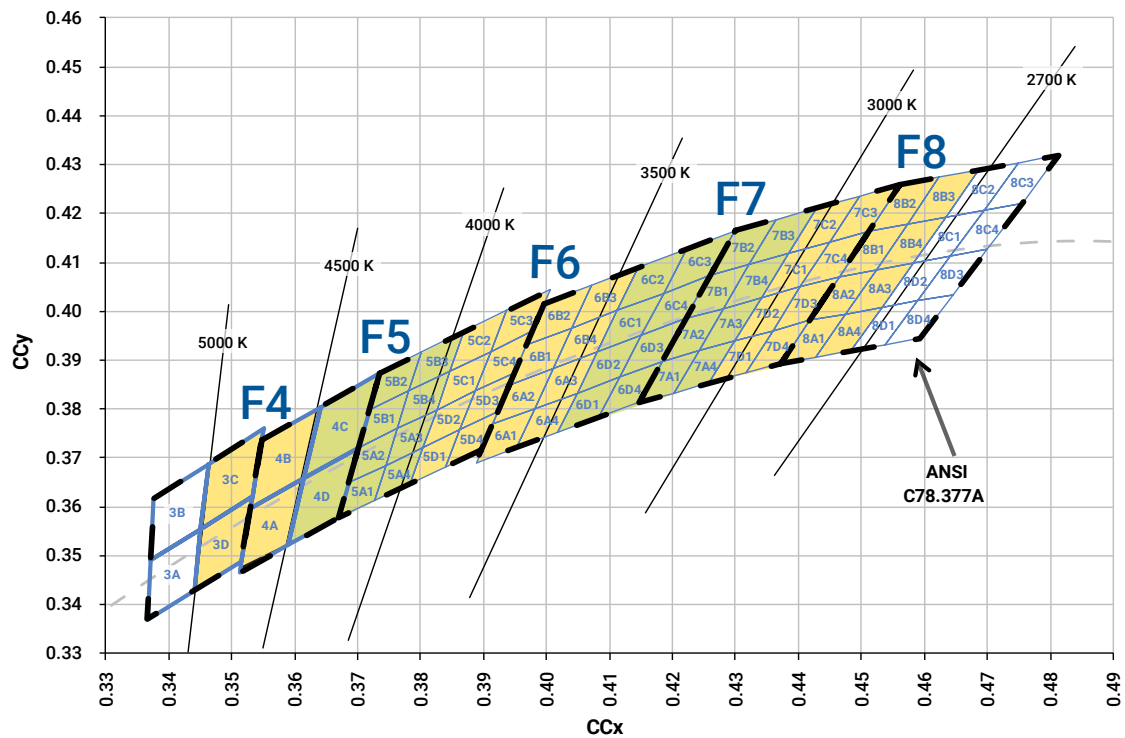
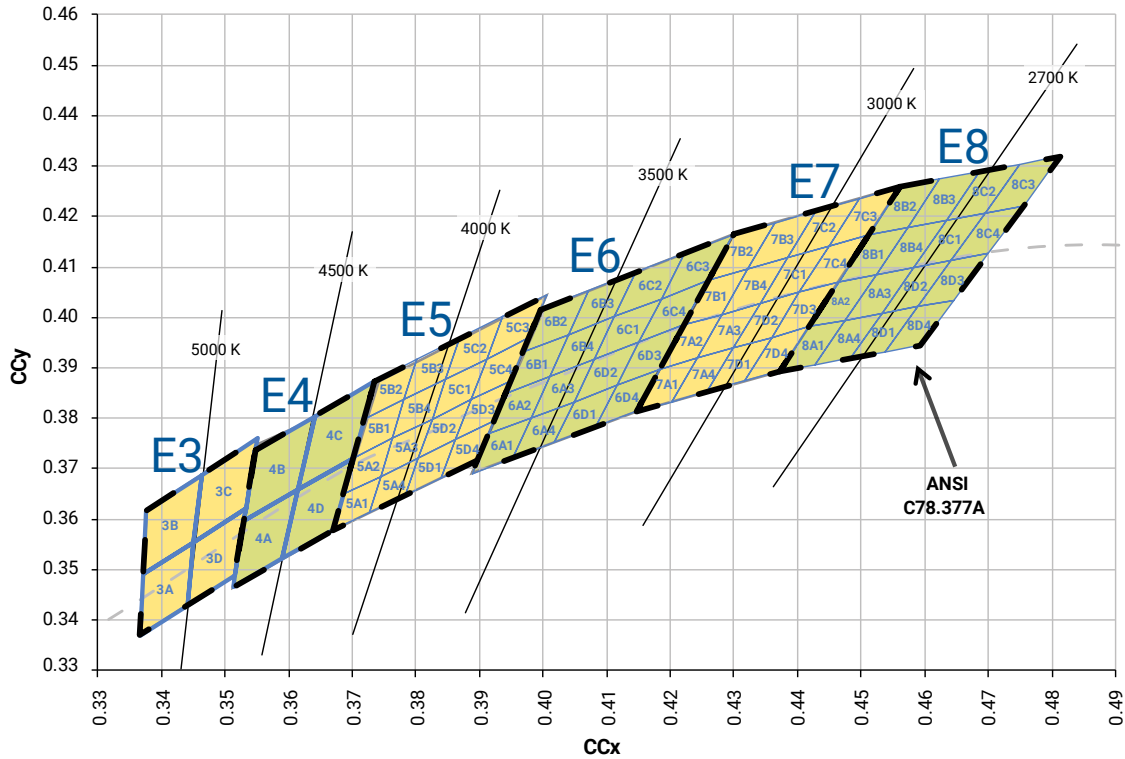

**CREE'S STANDARD CHROMATICITY KITS**

The following table provides the chromaticity bins associated with chromaticity kits.

| Color         | CCT    | Kit | Chromaticity Bins  |
|---------------|--------|-----|--|
| Cool White    | 6200 K | 51  | 0A, 0B, 0C, 0D, 0R, 0S, 0T, 0U, 1A, 1B, 1C, 1D, 1R, 1S, 1T, 1U, 2A, 2B, 2C, 2D, 2R, 2S, 2T, 2U, 3A, 3B, 3R, 3S |
|               | 6000 K | 53  | 1A, 1B, 1C, 1D, 1R, 1S, 1T, 1U, 2A, 2B, 2C, 2D, 2R, 2S, 2T, 3A, 3B, 3S   |
|               | 6200 K | 50  | 1A, 1B, 1C, 1D, 2A, 2B, 2C, 2D   |
| Neutral White | 5000 K | E3  | 3A, 3B, 3C, 3D   |
|               | 4750 K | F4  | 3C, 3D, 4A, 4B   |
|               | 4500 K | E4  | 4A, 4B, 4C, 4D   |
|               | 4250 K | F5  | 4C, 4D, 5A1, 5A2, 5A3, 5A4, 5B1, 5B2, 5B3, 5B4   |
|               | 4000 K | E5  | 5A1, 5A2, 5A3, 5A4, 5B1, 5B2, 5B3, 5B4, 5C1, 5C2, 5C3, 5C4, 5D1, 5D2, 5D3, 5D4                                 |
| Warm White    | 3750 K | F6  | 5C1, 5C2, 5C3, 5C4, 5D1, 5D2, 5D3, 5D4, 6A1, 6A2, 6A3, 6A4, 6B1, 6B2, 6B3, 6B4                                 |
|               | 3500 K | E6  | 6A1, 6A2, 6A3, 6A4, 6B1, 6B2, 6B3, 6B4, 6C1, 6C2, 6C3, 6C4, 6D1, 6D2, 6D3, 6D4                                 |
|               | 3250 K | F7  | 6C1, 6C2, 6C3, 6C4, 6D1, 6D2, 6D3, 6D4, 7A1, 7A2, 7A3, 7A4, 7B1, 7B2, 7B3, 7B4                                 |
|               | 3000 K | E7  | 7A1, 7A2, 7A3, 7A4, 7B1, 7B2, 7B3, 7B4, 7C1, 7C2, 7C3, 7C4, 7D1, 7D2, 7D3, 7D4                                 |
|               | 2850 K | F8  | 7C1, 7C2, 7C3, 7C4, 7D1, 7D2, 7D3, 7D4, 8A1, 8A2, 8A3, 8A4, 8B1, 8B2, 8B3, 8B4                                 |
|               | 2700 K | E8  | 8A1, 8A2, 8A3, 8A4, 8B1, 8B2, 8B3, 8B4, 8C1, 8C2, 8C3, 8C4, 8D1, 8D2, 8D3, 8D4                                 |

**BIN AND ORDER CODE FORMATS**

XP-E HEW bin codes and order codes are configured in the following manner:

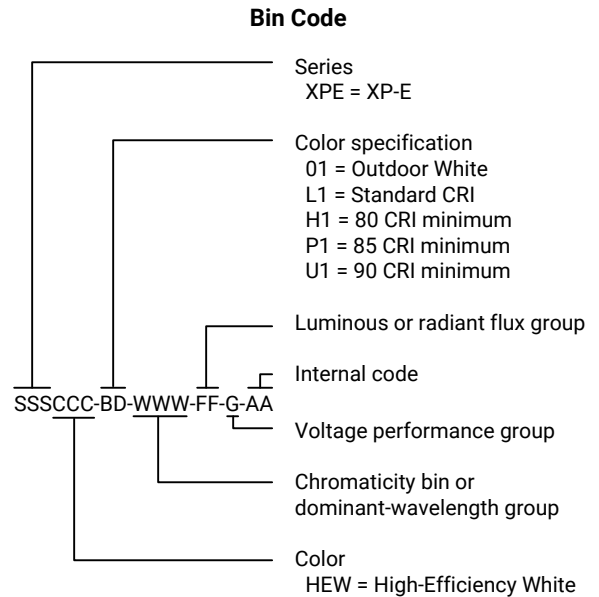
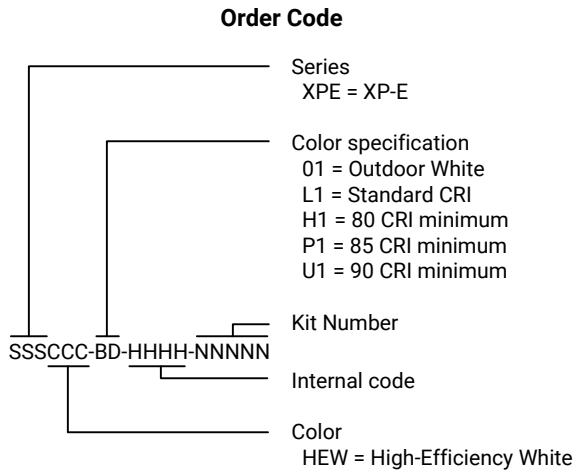



**REFLOW SOLDERING CHARACTERISTICS**

In testing, Cree has found XLamp XP-E HEW LEDs to be compatible with JEDEC J-STD-020C, using the parameters listed below. As a general guideline, Cree recommends that users follow the recommended soldering profile provided by the manufacturer of the solder paste used.

Note that this general guideline may not apply to all PCB designs and configurations of reflow soldering equipment.

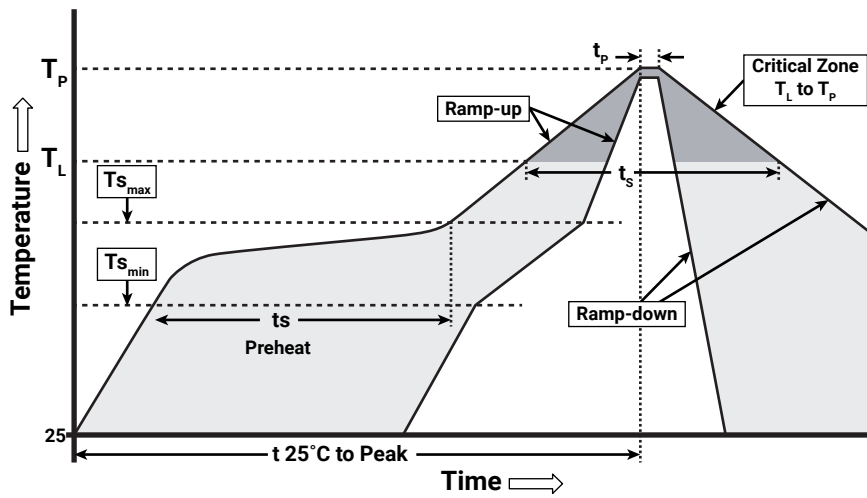

IPC/JEDEC J-STD-020C

| Profile Feature                                       | Lead-Free Solder |
|---|------------------|
| Average Ramp-Up Rate ( $T_{S_{max}}$ to $T_P$ )       | 1.2 °C/second    |
| Preheat: Temperature Min ( $T_{S_{min}}$ )            | 120 °C           |
| Preheat: Temperature Max ( $T_{S_{max}}$ )            | 170 °C           |
| Preheat: Time ( $t_{S_{min}}$ to $t_{S_{max}}$ )      | 65-150 seconds   |
| Time Maintained Above: Temperature ( $T_L$ )          | 217 °C           |
| Time Maintained Above: Time ( $t_t$ )                 | 45-90 seconds    |
| Peak/Classification Temperature ( $T_P$ )             | 235 - 245 °C     |
| Time Within 5 °C of Actual Peak Temperature ( $t_p$ ) | 20-40 seconds    |
| Ramp-Down Rate  | 1 - 6 °C/second  |
| Time 25 °C to Peak Temperature                        | 4 minutes max.   |

Note: All temperatures refer to topside of the package, measured on the package body surface.

## NOTES

---

### Measurements

The luminous flux, radiant power, chromaticity, forward voltage and CRI measurements in this document are binning specifications only and solely represent product measurements as of the date of shipment. These measurements will change over time based on a number of factors that are not within Cree's control and are not intended or provided as operational specifications for the products. Calculated values are provided for informational purposes only and are not intended as specifications.

### Pre-Release Qualification Testing

Please read the [LED Reliability Overview](#) for details of the qualification process Cree applies to ensure long-term reliability for XLamp LEDs and details of Cree's pre-release qualification testing for XLamp LEDs.

### Lumen Maintenance

Cree now uses standardized IES LM-80-08 and TM-21-11 methods for collecting long-term data and extrapolating LED lumen maintenance. For information on the specific LM-80 data sets available for this LED, refer to the public [LM-80 results document](#).

Cree currently recommends a maximum drive current of 700 mA for XLamp XP-E High-Efficiency White LEDs in designs seeking the ENERGY STAR® 35,000-hour lifetime rating\* ( $\geq 94.1\%$  luminous flux @ 6000 hours) or 1000-mA driver current in designs seeking the ENERGY STAR® 25,000-hour lifetime rating ( $\geq 91.8\%$  luminous flux @ 6000 hours).

Please read the [Long-Term Lumen Maintenance application note](#) for more details on Cree's lumen maintenance testing and forecasting. Please read the [Thermal Management application note](#) for details on how thermal design, ambient temperature, and drive current affect the LED junction temperature.

\* These lifetime ratings are based on the current ENERGY STAR Product Specification for Luminaires (Light Fixtures) V1.0 (February 16, 2011) and ENERGY STAR Program Requirements for Integral LED Lamps V1.4 (May 13, 2011) lumen maintenance criteria.

### Moisture Sensitivity

Cree recommends keeping XLamp LEDs in the provided, resealable moisture-barrier packaging (MBP) until immediately prior to soldering. Unopened MBPs that contain XLamp LEDs do not need special storage for moisture sensitivity.

Once the MBP is opened, XLamp XP-E HEW LEDs may be stored as MSL 1 per JEDEC J-STD-033, meaning they have unlimited floor life in conditions of  $\leq 30$  °C/85% relative humidity (RH). Regardless of the storage condition, Cree recommends sealing any unsoldered LEDs in the original MBP.

### RoHS Compliance

The levels of RoHS restricted materials in this product are below the maximum concentration values (also referred to as the threshold limits) permitted for such substances, or are used in an exempted application, in accordance with EU Directive 2011/65/EC (RoHS2), as implemented January 2, 2013. RoHS Declarations for this product can be obtained from your Cree representative or from the [Product Ecology](#) section of the Cree website.

**NOTES - CONTINUED**

---

**REACH Compliance**

REACH substances of very high concern (SVHCs) information is available for this product. Since the European Chemical Agency (ECHA) has published notice of their intent to frequently revise the SVHC listing for the foreseeable future, please contact a Cree representative to insure you get the most up-to-date REACH SVHC Declaration. REACH banned substance information (REACH Article 67) is also available upon request.

**UL® Recognized Component**

Level 4 enclosure consideration. The LED package or a portion thereof has been investigated as a fire and electrical enclosure per ANSI/UL 8750.

**Vision Advisory**

WARNING: Do not look at an exposed lamp in operation. Eye injury can result. For more information about LEDs and eye safety, please refer to the [LED Eye Safety application note](#).

**MECHANICAL DIMENSIONS (T<sub>A</sub> = 25 °C)**

Thermal vias, if present, are not shown on these drawings.

All measurements are ±.13 mm unless otherwise indicated.

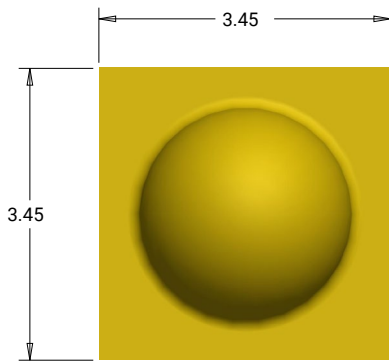

**Top View**

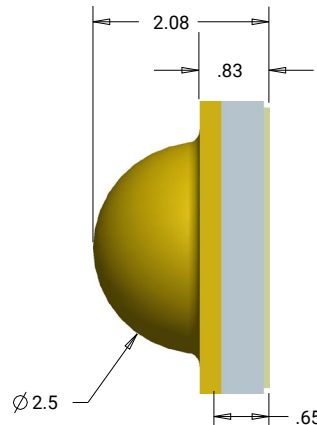

**Side View**

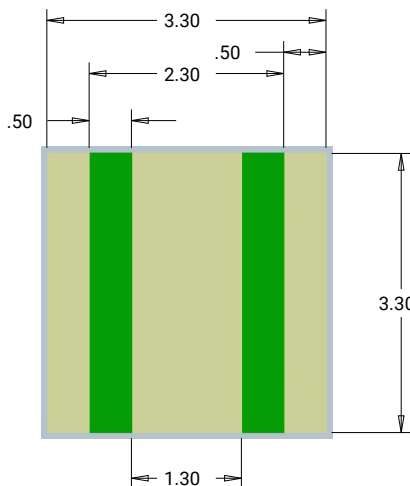

**Bottom View**

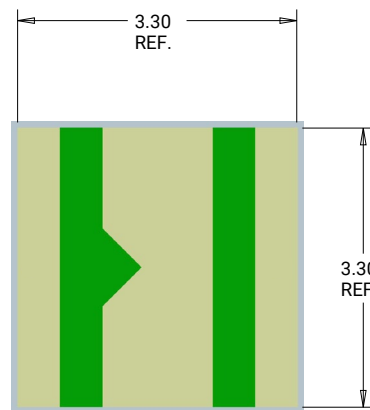

**Alternate Bottom View**

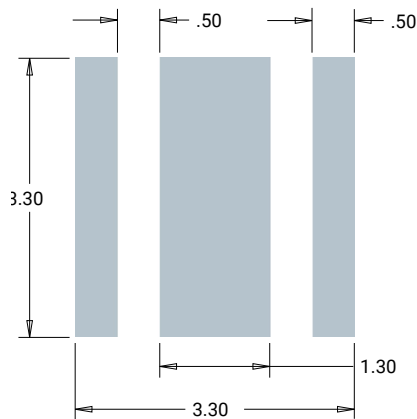

**Recommended PCB Solder Pad**

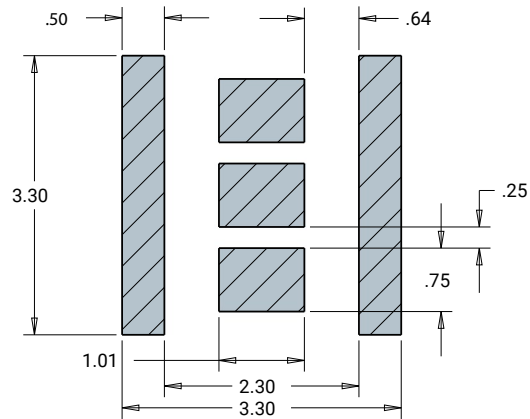

**Recommended Stencil Pattern  
(Hatched Area is Open)**

**TAPE AND REEL**

All Cree carrier tapes conform to EIA-481D, Automated Component Handling Systems Standard.

Except as noted, all dimensions in mm.

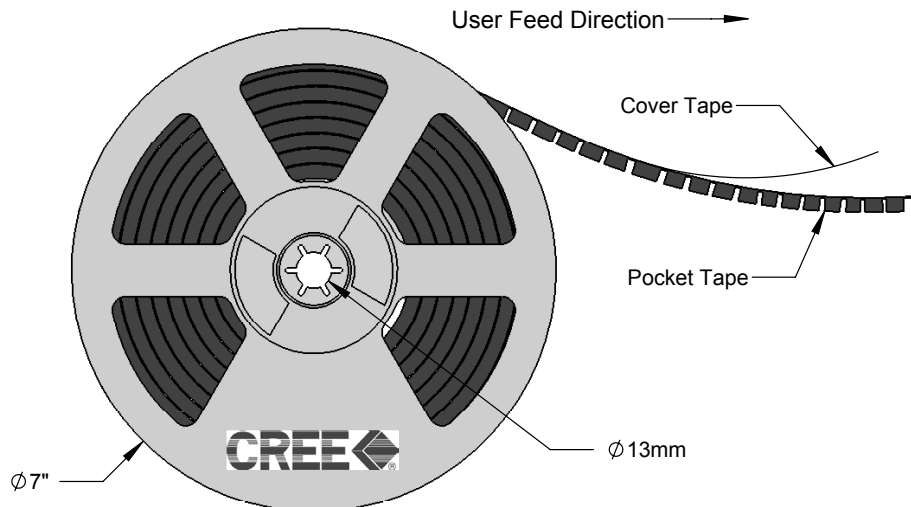
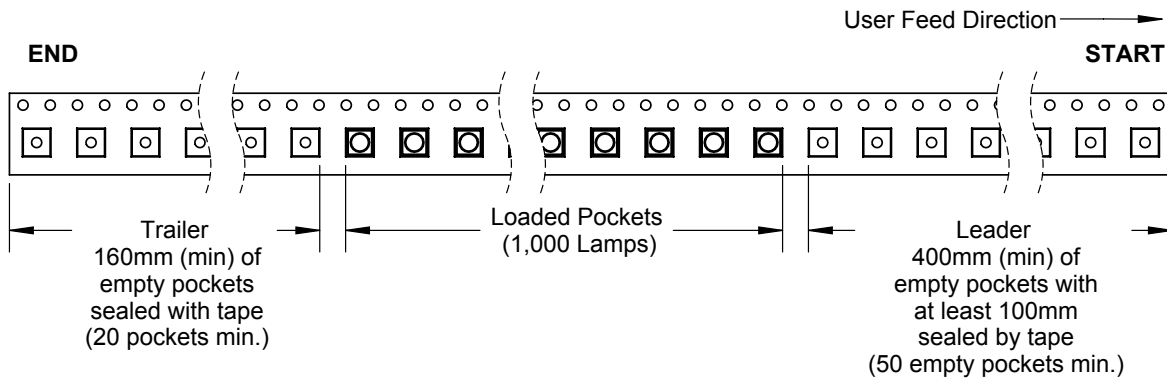
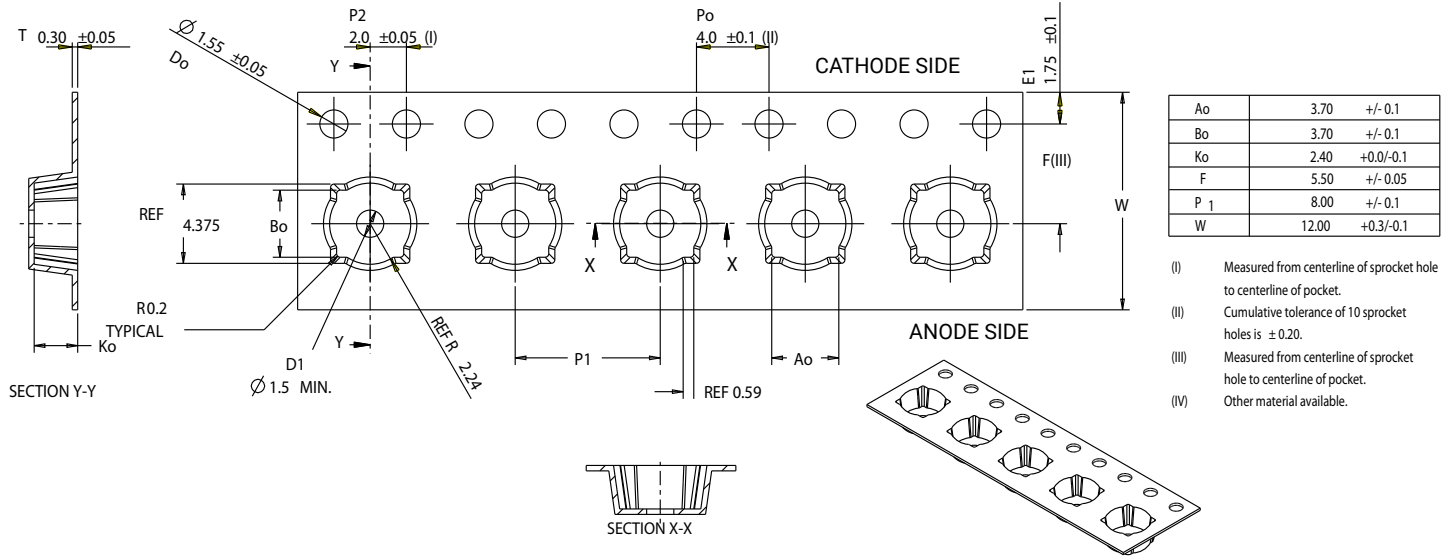

**PACKAGING**

**Unpackaged Reel**

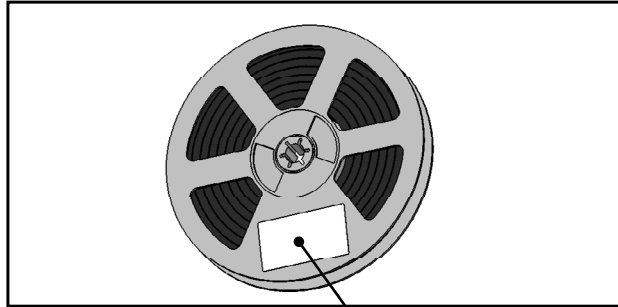

Label with Cree Bin Code,  
Quantity, Reel ID

**Packaged Reel**

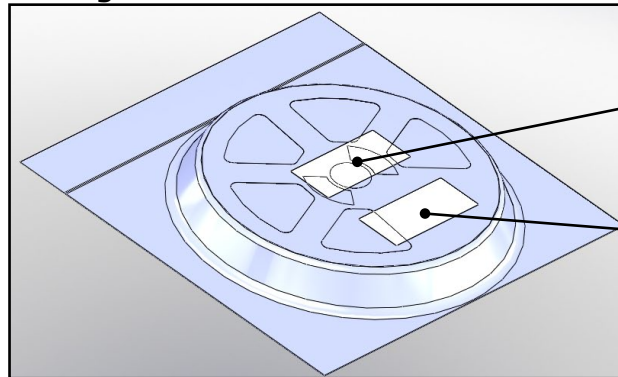

Label with Cree Order Code,  
Quantity, Reel ID, PO #

Label with Cree Bin Code,  
Quantity, Reel ID

**Boxed Reel**

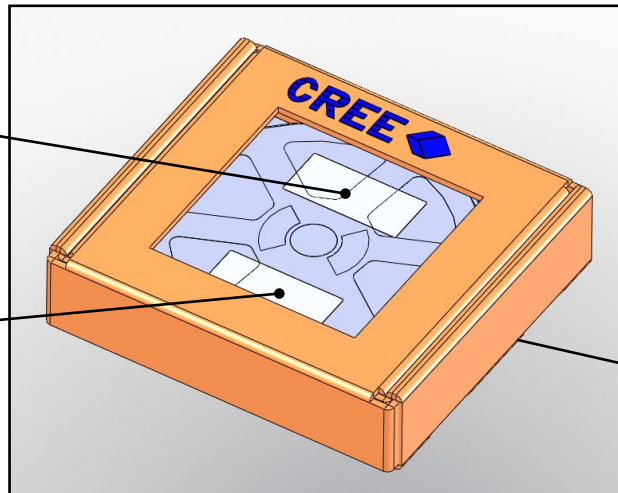

Label with Cree Order Code,  
Quantity, Reel ID, PO #

Label with Cree Bin Code,  
Quantity, Reel ID

Patent Label  
(on bottom of box)