

## Cree® XLamp® XQ-D LED



### PRODUCT DESCRIPTION

Cree XLamp® XQ-D LEDs revolutionize low-cost, high-power LEDs by delivering lighting-class reliability and a wider spread of light than typical plastic packages. The XQ-D's innovative wide light emission can improve the omnidirectionality of replacement lamps, while also reducing system cost by using fewer LEDs.

Using Cree's newest generation of silicon carbide-based LED chips, XQ-D is optimized to dramatically lower system cost in replacement lamp, non-directional and outdoor area lighting applications.

### FEATURES

- Cree's smallest lighting class LED: 1.6 X 1.6 X 1.6 mm
- Available in white, 80-minimum CRI white, and 70-minimum CRI cool white
- Binned at 25 °C
- 700 mA maximum drive current
- Low thermal resistance: 7.5 °C/W
- Wide viewing angle: 145°
- Reflow solderable - JEDEC J-STD-020C compatible
- Unlimited floor life at ≤ 30 °C/85% RH
- RoHS and REACH compliant
- UL® recognized component (E349212)

### TABLE OF CONTENTS

Characteristics .....	2
Flux Characteristics .....	3
Relative Spectral Power Distribution ....	4
Relative Flux vs. Junction Temperature .....	4
Electrical Characteristics .....	5
Relative Flux vs. Current .....	5
Typical Spatial Distribution .....	6
Thermal Design .....	6
Reflow Soldering Characteristics .....	7
Notes .....	8
Mechanical Dimensions .....	10
Tape and Reel .....	11
Packaging .....	12



**CHARACTERISTICS**

Characteristics	Unit	Minimum	Typical	Maximum
Thermal resistance, junction to solder point	°C/W		7.5	
Viewing angle (FWHM)	degrees		145	
Temperature coefficient of voltage	mV/°C		-3	
ESD classification (HBM per Mil-Std-883D)			Class 1	
DC forward current	mA		350	700
Reverse voltage	V			-5
Forward voltage (@ 350 mA, 25 °C)	V		3.1	3.5
LED junction temperature	°C			150

## FLUX CHARACTERISTICS ( $T_j = 25\text{ }^\circ\text{C}$ )

The following table provides several base order codes for XLamp XQ-D LEDs. It is important to note that the base order codes listed here are a subset of the total available order codes for the product family. For more order codes, as well as a complete description of the order-code nomenclature, please consult the XLamp XQ LED Family Binning and Labeling document.

Color	CCT Range		Minimum Luminous Flux @ 350 mA		Calculated Minimum Luminous Flux (lm)*	Order Code
	Min.	Max.	Group	Flux (lm)	700 mA	
Cool White	5000 K	8300 K	R4	130	227	XQDAWT-00-0000-00000LG51
			R3	122	213	XQDAWT-00-0000-00000LF51
			R2	114	199	XQDAWT-00-0000-00000LE51
70 CRI Minimum Cool White	5000 K	8300 K	R4	130	227	XQDAWT-00-0000-00000BG51
			R3	122	213	XQDAWT-00-0000-00000BF51
			R2	114	199	XQDAWT-00-0000-00000BE51
Neutral White	3700 K	5000 K	R3	122	213	XQDAWT-00-0000-00000BFE5
			R2	114	199	XQDAWT-00-0000-00000BEE5
			Q5	107	187	XQDAWT-00-0000-00000LDE5
80 CRI Minimum White	2600 K	4300 K	Q4	100	172	XQDAWT-00-0000-00000HCE7
			Q3	93.9	164	XQDAWT-00-0000-00000HBE7
			Q2	87.4	153	XQDAWT-00-0000-00000HAE7
Warm White	2600 K	3700 K	Q4	100	172	XQDAWT-00-0000-00000LCE7
			Q3	93.9	164	XQDAWT-00-0000-00000LBE7
			Q2	87.4	153	XQDAWT-00-0000-00000LAE7

### Notes:

- Cree maintains a tolerance of  $\pm 7\%$  on flux and power measurements,  $\pm 0.005$  on chromaticity (CCx, CCy) measurements and  $\pm 2$  on CRI measurements. See the Measurements section (page 8).
- Typical CRI for Neutral White, 3700 K - 5000K CCT is 75.
- Typical CRI for Warm White, 2600 K - 3700 K CCT is 80.
- Minimum CRI for 70 CRI Minimum Cool White is 70.
- Minimum CRI for 80 CRI Minimum White is 80.
- \* Calculated flux values at 700 mA are for reference only.

**RELATIVE SPECTRAL POWER DISTRIBUTION**

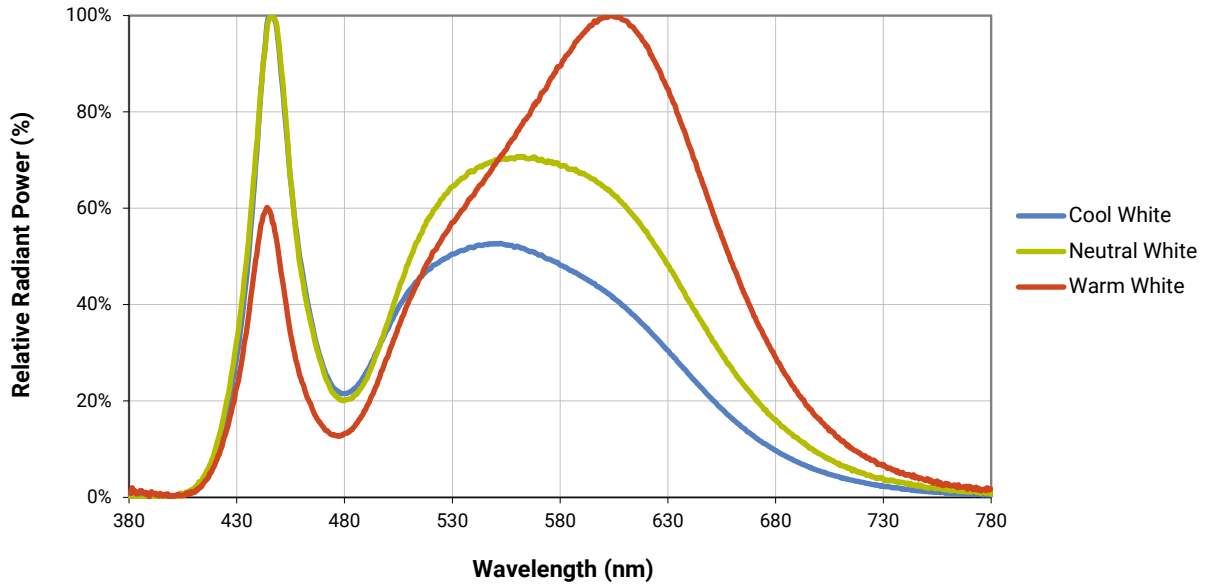

**RELATIVE FLUX VS. JUNCTION TEMPERATURE ( $I_F = 350$  mA)**

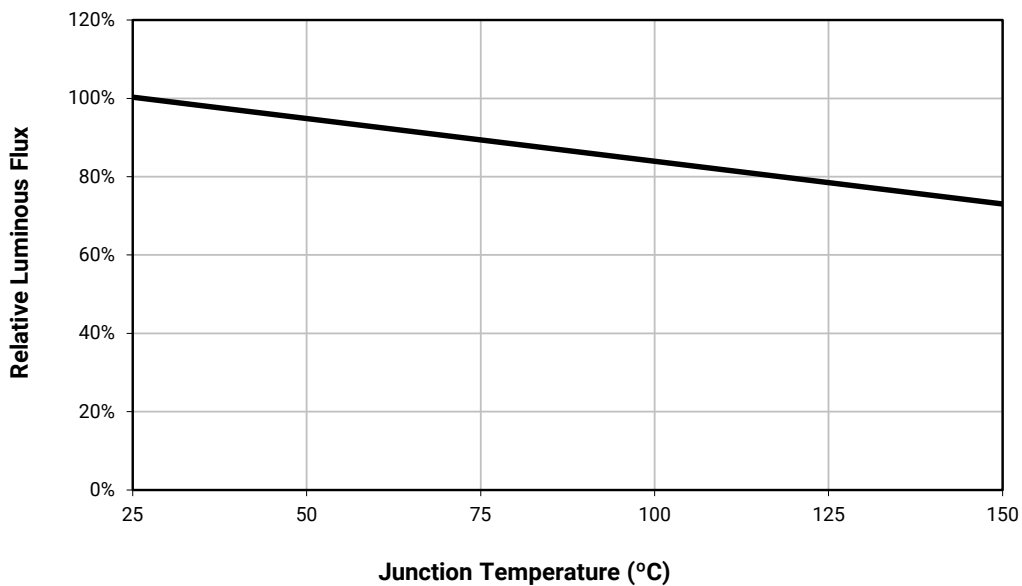

**ELECTRICAL CHARACTERISTICS ( $T_j = 25\text{ }^\circ\text{C}$ )**

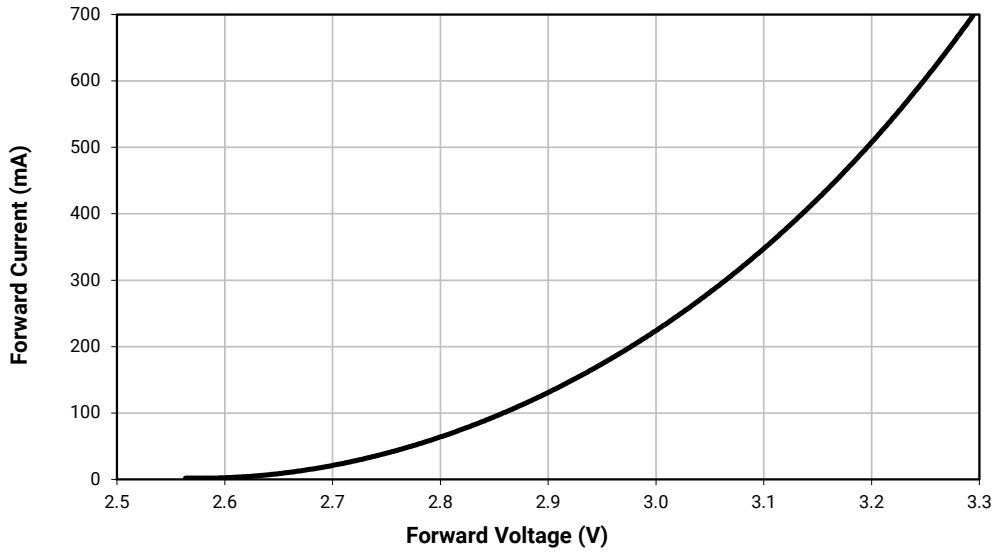

**RELATIVE FLUX VS. CURRENT ( $T_j = 25\text{ }^\circ\text{C}$ )**

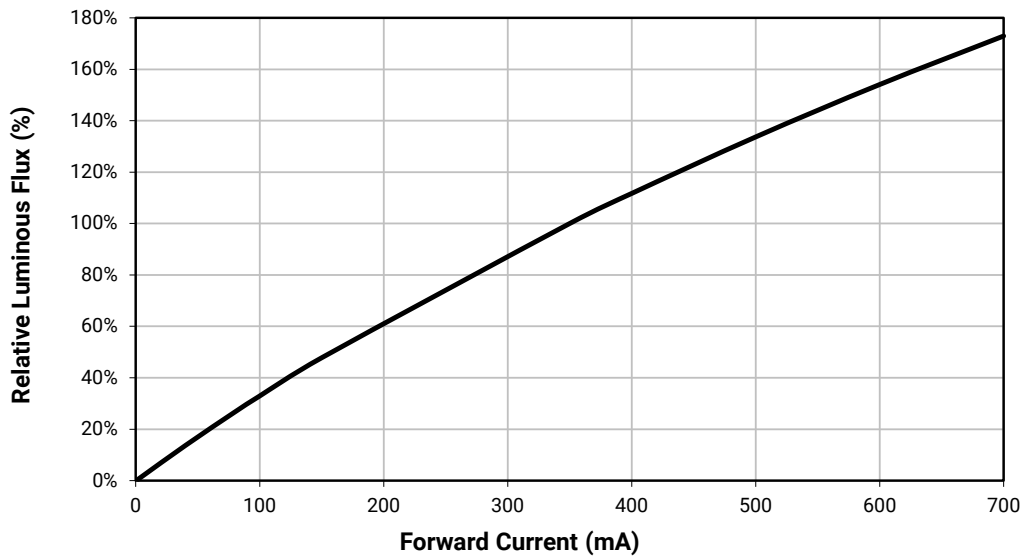

**TYPICAL SPATIAL DISTRIBUTION**

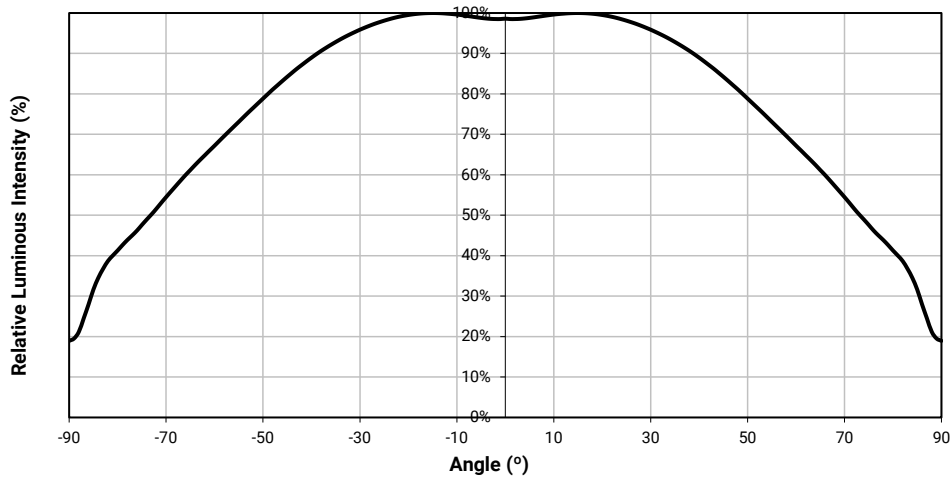

**THERMAL DESIGN**

The maximum forward current is determined by the thermal resistance between the LED junction and ambient. It is crucial for the end product to be designed in a manner that minimizes the thermal resistance from the solder point to ambient in order to optimize lamp life and optical characteristics.

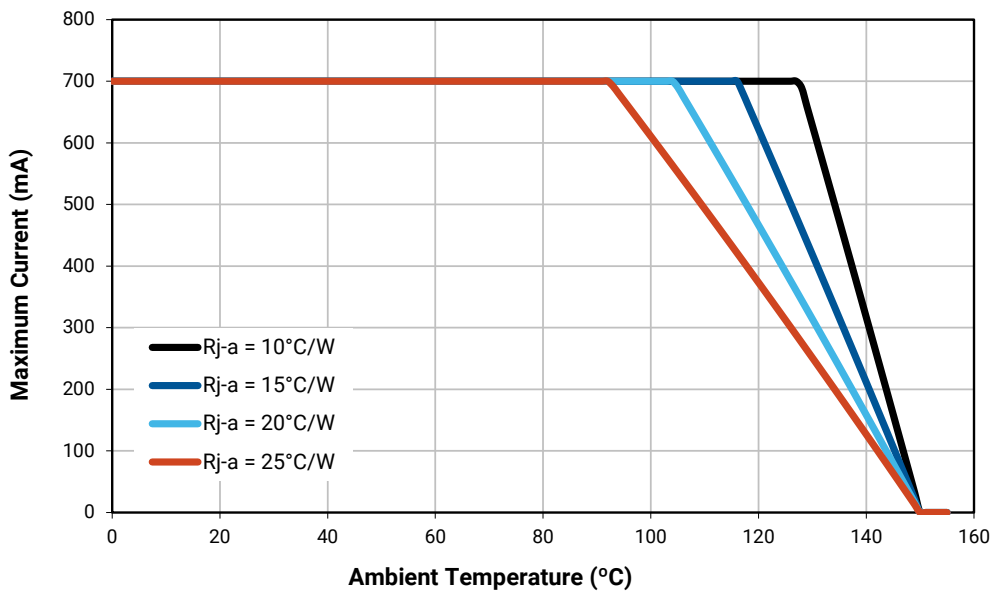

**REFLOW SOLDERING CHARACTERISTICS**

In testing, Cree has found XLamp XQ-D LEDs to be compatible with JEDEC J-STD-020C, using the parameters listed below. As a general guideline, Cree recommends that users follow the recommended soldering profile provided by the manufacturer of the solder paste used.

Note that this general guideline may not apply to all PCB designs and configurations of reflow soldering equipment.

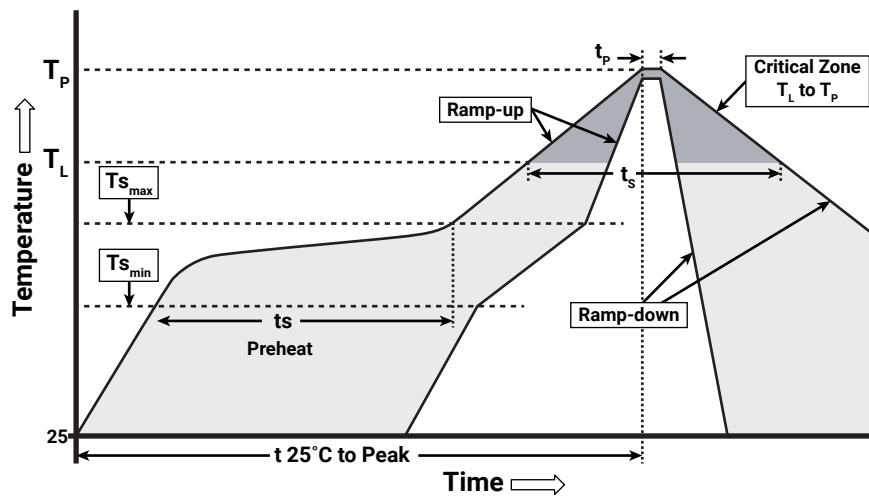

IPC/JEDEC J-STD-020C

Profile Feature	Lead-Free Solder
Average Ramp-Up Rate ( $T_{s_{max}}$ to $T_P$ )	1.2 °C/second
Preheat: Temperature Min ( $T_{s_{min}}$ )	120 °C
Preheat: Temperature Max ( $T_{s_{max}}$ )	170 °C
Preheat: Time ( $t_{s_{min}}$ to $t_{s_{max}}$ )	65-150 seconds
Time Maintained Above: Temperature ( $T_L$ )	217 °C
Time Maintained Above: Time ( $t_s$ )	45-90 seconds
Peak/Classification Temperature ( $T_P$ )	235 - 245 °C
Time Within 5 °C of Actual Peak Temperature ( $t_p$ )	20-40 seconds
Ramp-Down Rate	1 - 6 °C/second
Time 25 °C to Peak Temperature	4 minutes max.

Note: All temperatures refer to topside of the package, measured on the package body surface.

## NOTES

---

### Measurements

The luminous flux, radiant power, chromaticity, forward voltage and CRI measurements in this document are binning specifications only and solely represent product measurements as of the date of shipment. These measurements will change over time based on a number of factors that are not within Cree's control and are not intended or provided as operational specifications for the products. Calculated values are provided for informational purposes only and are not intended as specifications.

### Pre-Release Qualification Testing

Please read the [LED Reliability Overview](#) for details of the qualification process Cree applies to ensure long-term reliability for XLamp LEDs and details of Cree's pre-release qualification testing for XLamp LEDs.

### Lumen Maintenance

Cree now uses standardized IES LM-80-08 and TM-21-11 methods for collecting long-term data and extrapolating LED lumen maintenance. For information on the specific LM-80 data sets available for this LED, refer to the public [LM-80 results document](#).

Please read the [Long-Term Lumen Maintenance application note](#) for more details on Cree's lumen maintenance testing and forecasting. Please read the [Thermal Management application note](#) for details on how thermal design, ambient temperature, and drive current affect the LED junction temperature.

### Moisture Sensitivity

Cree recommends keeping XLamp LEDs in the provided, resealable moisture-barrier packaging (MBP) until immediately prior to soldering. Unopened MBPs that contain XLamp LEDs do not need special storage for moisture sensitivity.

Once the MBP is opened, XLamp XQ-D LEDs may be stored as MSL 1 per JEDEC J-STD-033, meaning they have unlimited floor life in conditions of  $\leq 30$  °C/85% relative humidity (RH). Regardless of storage condition, Cree recommends sealing any unsoldered LEDs in the original MBP.

### RoHS Compliance

The levels of RoHS restricted materials in this product are below the maximum concentration values (also referred to as the threshold limits) permitted for such substances, or are used in an exempted application, in accordance with EU Directive 2011/65/EC (RoHS2), as implemented January 2, 2013. RoHS Declarations for this product can be obtained from your Cree representative or from the [Product Ecology](#) section of the Cree website.

### REACH Compliance

REACH substances of very high concern (SVHCs) information is available for this product. Since the European Chemical Agency (ECHA) has published notice of their intent to frequently revise the SVHC listing for the foreseeable future, please contact a Cree representative to insure you get the most up-to-date REACH SVHC Declaration. REACH banned substance information (REACH Article 67) is also available upon request.



**NOTES - CONTINUED**

---

**UL® Recognized Component**

Level 1 enclosure consideration. The LED package or a portion thereof has not been investigated as a fire enclosure or a fire and electrical enclosure per ANSI/UL 8750.

**Vision Advisory**

WARNING: Do not look at an exposed lamp in operation. Eye injury can result. For more information about LEDs and eye safety, please refer to the [LED Eye Safety application note](#).

**MECHANICAL DIMENSIONS**

All dimensions in mm.

Measurement tolerances unless indicated otherwise:  $\pm .13$  mm

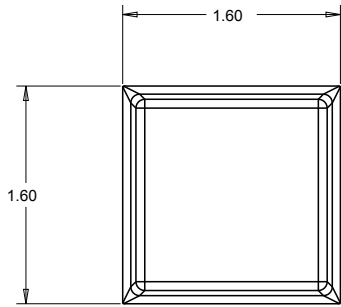

**Top View**

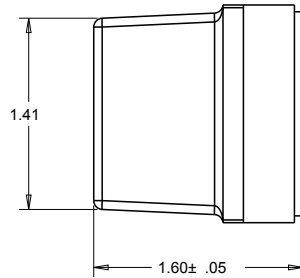

**Side View**

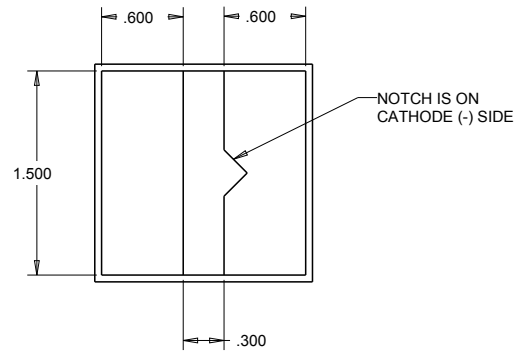

**Bottom View**

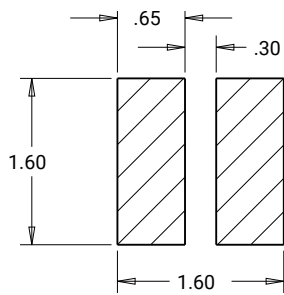

**Recommended PCB solder pad**

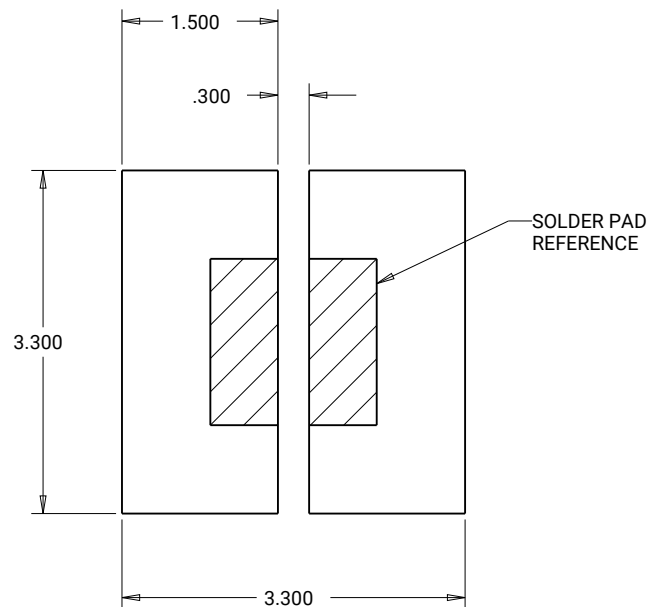

**Recommended trace layout**



**PACKAGING**

The diagrams below show the packaging and labels Cree uses to ship XLamp XQ-D LEDs. XLamp XQ-D LEDs are shipped in tape loaded on a reel. Each box contains only one reel in a moisture barrier bag.

**Unpackaged Reel**

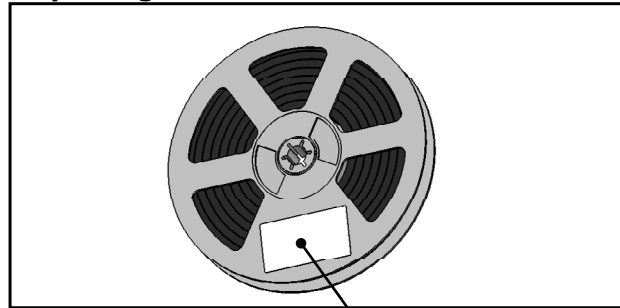

Label with Cree Bin Code, Quantity, Reel ID

**Packaged Reel**

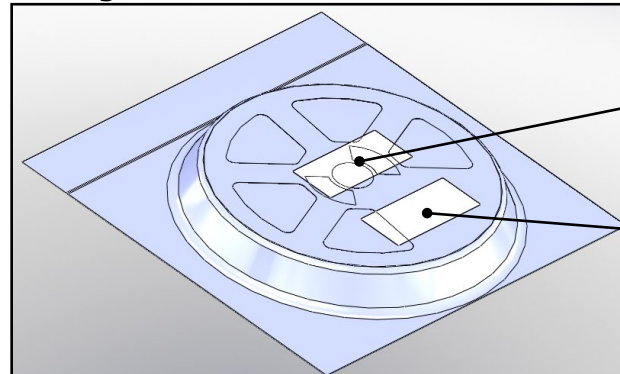

Label with Cree Order Code, Quantity, Reel ID, PO #

Label with Cree Bin Code, Quantity, Reel ID

**Boxed Reel**

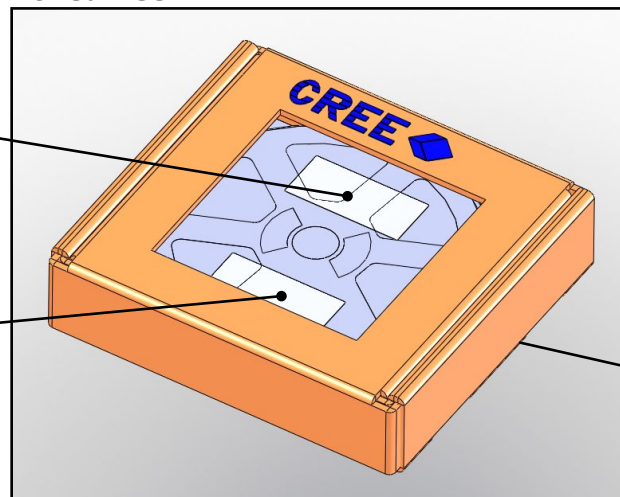

Label with Cree Order Code, Quantity, Reel ID, PO #

Label with Cree Bin Code, Quantity, Reel ID

Patent Label (on bottom of box)