

# C3D02065E

## Silicon Carbide Schottky Diode

### Z-REC<sup>®</sup> RECTIFIER

$V_{RRM}$	=	650 V
$I_F (T_c=135^\circ\text{C})$	=	4 A
$Q_c$	=	4.8 nC

### Features

- 650-Volt Schottky Rectifier
- Optimized for PFC Boost Diode Application
- Zero Reverse Recovery Current
- Zero Forward Recovery Voltage
- High-Frequency Operation
- Temperature-Independent Switching Behavior
- Extremely Fast Switching
- Positive Temperature Coefficient on  $V_F$

### Benefits

- Replace Bipolar with Unipolar Rectifiers
- Essentially No Switching Losses
- Higher Efficiency
- Reduction of Heat Sink Requirements
- Parallel Devices Without Thermal Runaway

### Applications

- Switch Mode Power Supplies
- Power Factor Correction  
- Typical PFC  $P_{out}$  : 300W-450W

### Package



TO-252-2



Part Number	Package	Marking
C3D02065E	TO-252-2	C3D02065

### Maximum Ratings

Symbol	Parameter	Value	Unit	Test Conditions	Note
$V_{RRM}$	Repetitive Peak Reverse Voltage	650	V		
$V_{RSM}$	Surge Peak Reverse Voltage	650	V		
$V_{DC}$	DC Blocking Voltage	650	V		
$I_F$	Continuous Forward Current	8 4 2	A	$T_c=25^\circ\text{C}$ $T_c=135^\circ\text{C}$ $T_c=162^\circ\text{C}$	
$I_{FRM}$	Repetitive Peak Forward Surge Current	12 9	A	$T_c=25^\circ\text{C}, t_p=10\text{ mS}, \text{Half Sine Wave } D=0.3$ $T_c=110^\circ\text{C}, t_p=10\text{ mS}, \text{Half Sine Wave } D=0.3$	
$I_{FSM}$	Non-Repetitive Peak Forward Surge Current	21 19	A	$T_c=25^\circ\text{C}, t_p=10\text{ mS}, \text{Half Sine Wave } D=0.3$ $T_c=110^\circ\text{C}, t_p=10\text{ mS}, \text{Half Sine Wave } D=0.3$	
$I_{FSM}$	Non-Repetitive Peak Forward Surge Current	65	A	$T_c=25^\circ\text{C}, t_p=10\text{ }\mu\text{S}, \text{Pulse}$	
$P_{tot}$	Power Dissipation	39.5 17	W	$T_c=25^\circ\text{C}$ $T_c=110^\circ\text{C}$	
$T_J, T_{stg}$	Operating Junction and Storage Temperature	-55 to +175	$^\circ\text{C}$		

## Electrical Characteristics

Symbol	Parameter	Typ.	Max.	Unit	Test Conditions	Note
$V_F$	Forward Voltage	1.5 1.8	1.8 2.4	V	$I_F = 2\text{ A}$ $T_J = 25^\circ\text{C}$ $I_F = 2\text{ A}$ $T_J = 175^\circ\text{C}$	
$I_R$	Reverse Current	10 20	50 100	$\mu\text{A}$	$V_R = 650\text{ V}$ $T_J = 25^\circ\text{C}$ $V_R = 650\text{ V}$ $T_J = 175^\circ\text{C}$	
$Q_C$	Total Capacitive Charge	4.8		nC	$V_R = 650\text{ V}$ , $I_F = 2\text{ A}$ $di/dt = 500\text{ A}/\mu\text{s}$ $T_J = 25^\circ\text{C}$	
C	Total Capacitance	120 12 11		pF	$V_R = 0\text{ V}$ , $T_J = 25^\circ\text{C}$ , $f = 1\text{ MHz}$ $V_R = 200\text{ V}$ , $T_J = 25^\circ\text{C}$ , $f = 1\text{ MHz}$ $V_R = 400\text{ V}$ , $T_J = 25^\circ\text{C}$ , $f = 1\text{ MHz}$	

Note:

1. This is a majority carrier diode, so there is no reverse recovery charge.

## Thermal Characteristics

Symbol	Parameter	Typ.	Unit
$R_{\theta JC}$	TO-252 Package Thermal Resistance from Junction to Case	3.8	$^\circ\text{C}/\text{W}$

## Typical Performance

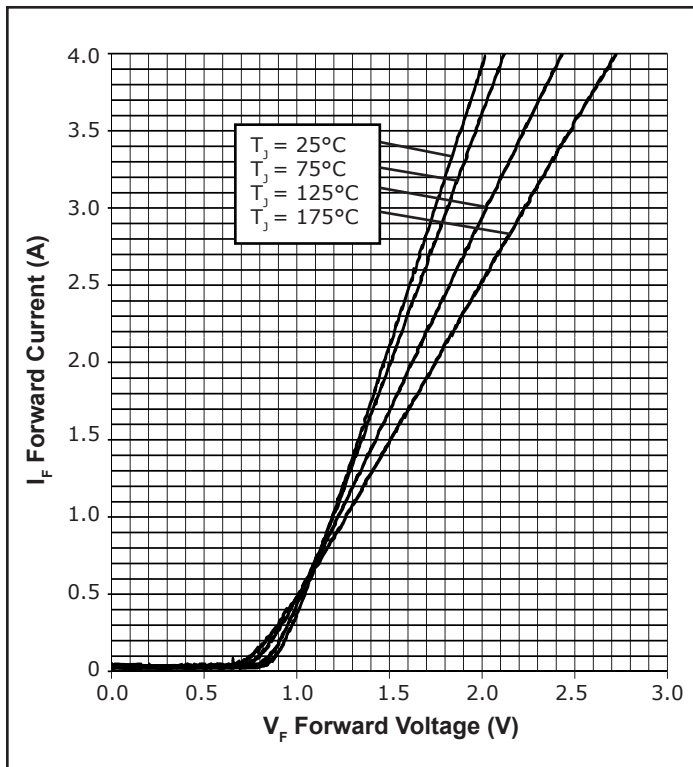

Figure 1. Forward Characteristics

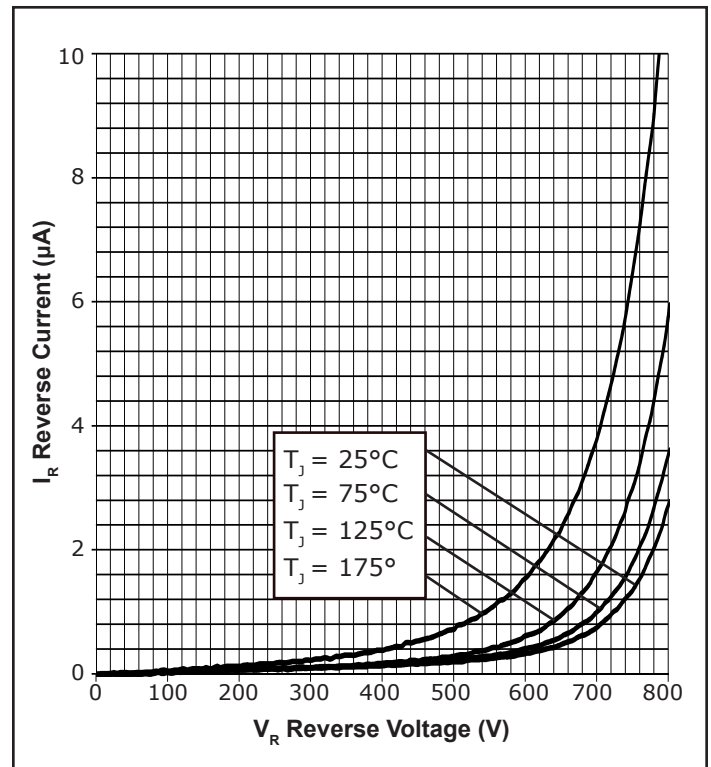

Figure 2. Reverse Characteristics

### Typical Performance

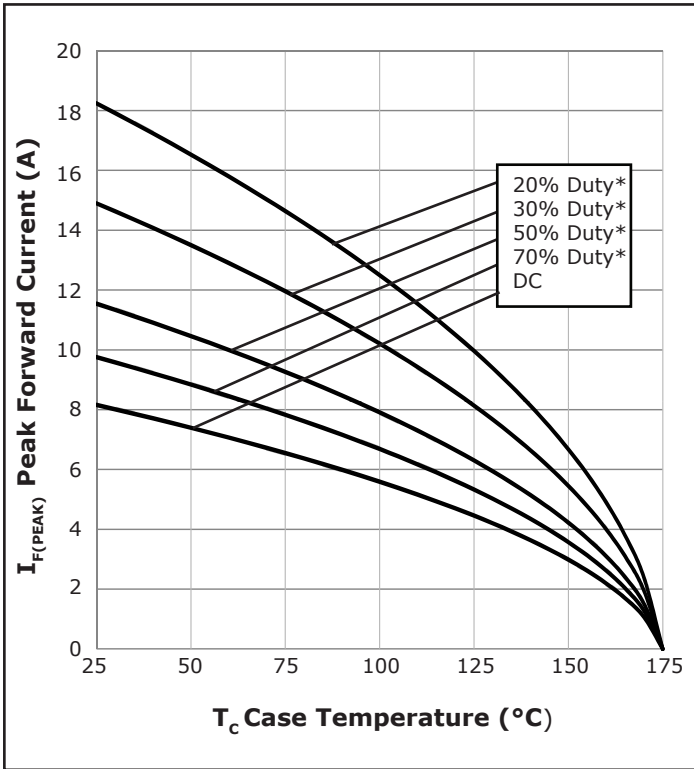

Figure 3. Current Derating

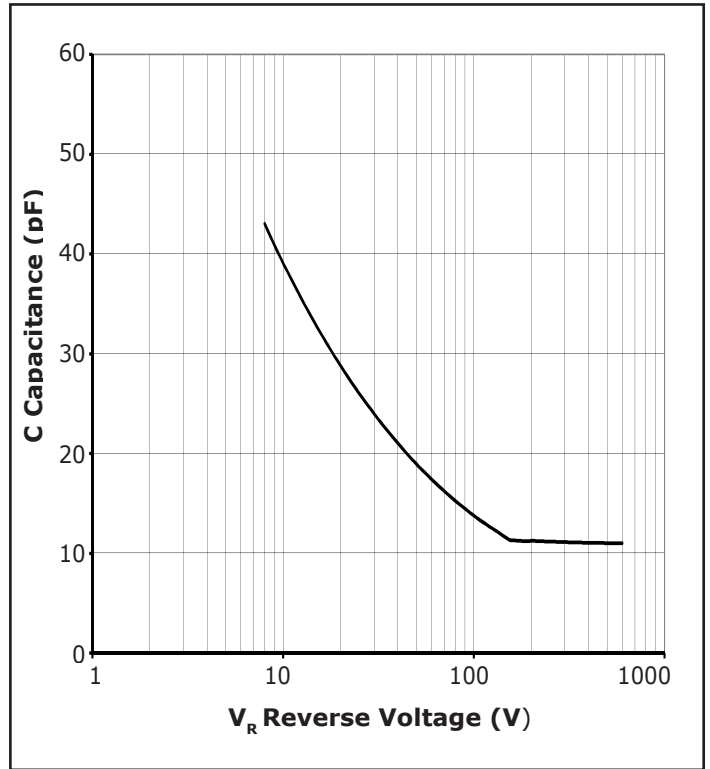

Figure 4. Capacitance vs. Reverse Voltage

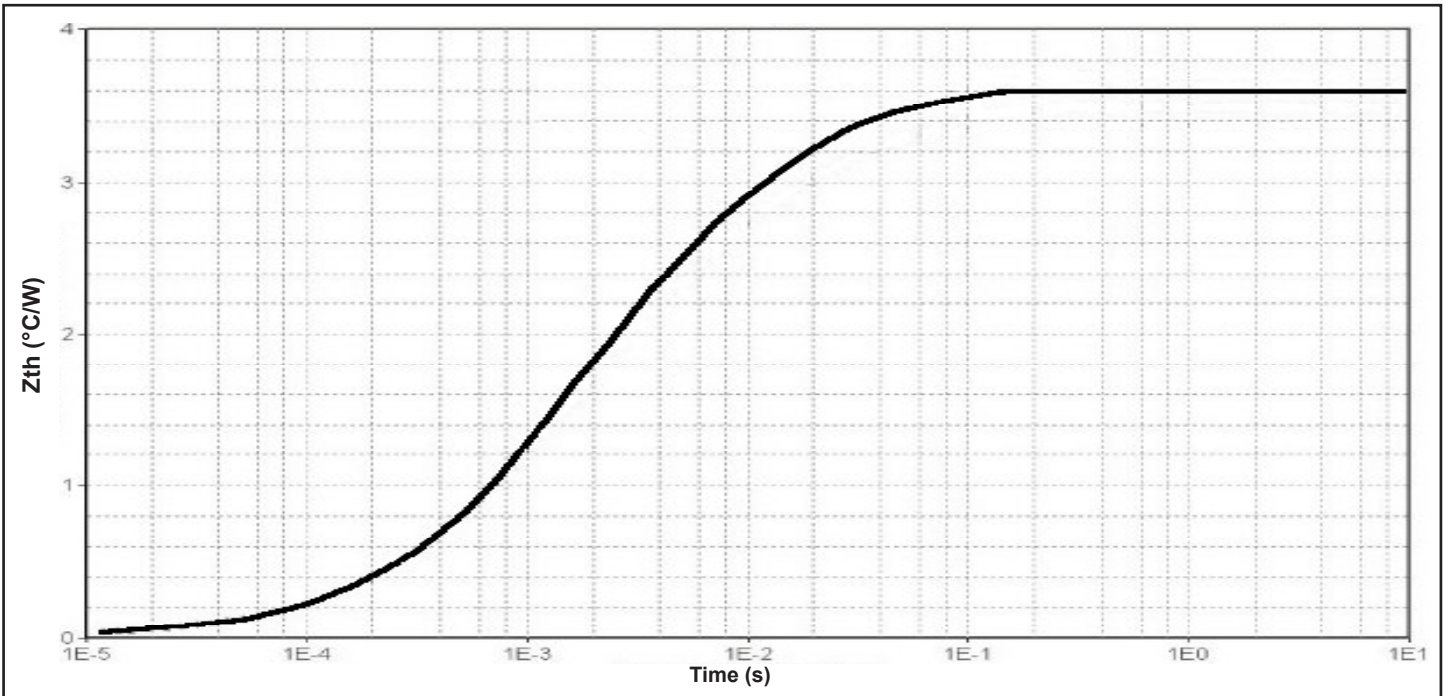

Figure 5. Transient Thermal Impedance

## Typical Performance

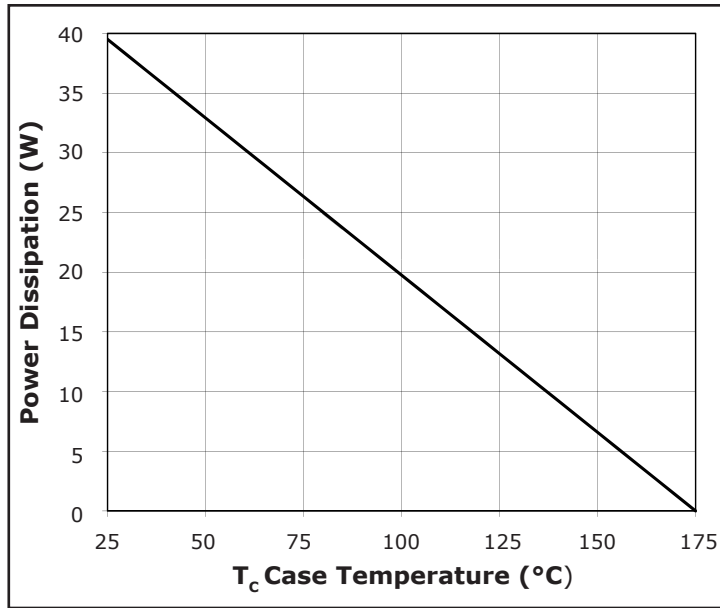
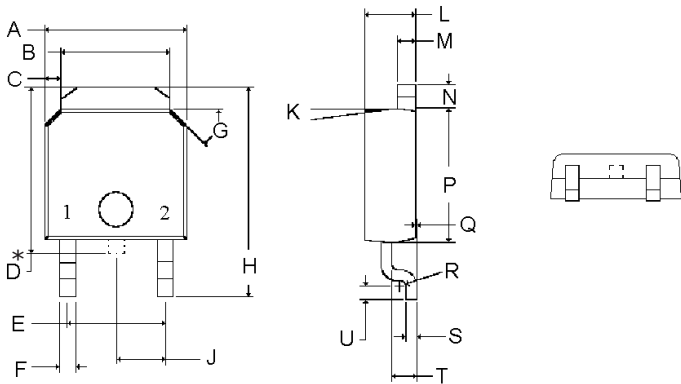

Figure 6. Power Derating

## Package Dimensions

Package TO-252-2



POS	Inches		Millimeters	
	Min	Max	Min	Max
A	.250	.289	6.350	7.341
B	.197	.215	5.004	5.461
C	.027	.050	.686	1.270
D*	.270	.322	6.858	8.179
E	.178	.182	4.521	4.623
F	.025	.045	.635	1.143
G	44°	46°	44°	46°
H	.380	.410	9.652	10.414
J	.090 TYP		2.286 TYP	
K	6°	8°	6°	8°
L	.086	.094	2.184	2.388
M	.018	.034	.457	.864
N	.035	.050	.889	1.270
P	.231	.246	5.867	6.248
Q	0.00	.005	0.00	.127
R	R0.010 TYP		R0.254 TYP	
S	.017	.023	.432	.584
T	.038	.045	.965	1.143
U	.021	.029	.533	.737

Note:

\* Tab "D" may not be present

## Recommended Solder Pad Layout

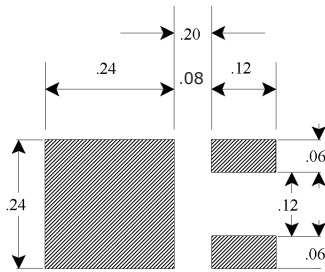

TO-252-2

Part Number	Package	Marking
C3D02065E	TO-252-2	C3D02065

Note: Recommended soldering profiles can be found in the applications note here: [http://www.cree.com/power\\_app\\_notes/soldering](http://www.cree.com/power_app_notes/soldering)



## Diode Model

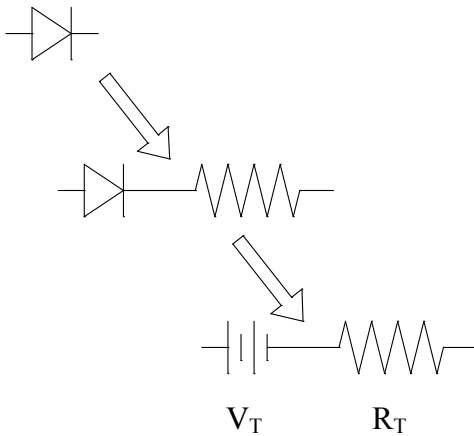

$$V_{fT} = V_T + I_f * R_T$$

$$V_T = 0.98 + (T_j * -1.7 * 10^{-3})$$

$$R_T = 0.21 + (T_j * 1.71 * 10^{-3})$$

Note:  $T_j$  = Diode Junction Temperature In Degrees Celsius, valid from 25°C to 175°C



## Notes

---

- **RoHS Compliance**

The levels of RoHS restricted materials in this product are below the maximum concentration values (also referred to as the threshold limits) permitted for such substances, or are used in an exempted application, in accordance with EU Directive 2011/65/EC (RoHS2), as implemented January 2, 2013. RoHS Declarations for this product can be obtained from your Cree representative or from the Product Documentation sections of [www.cree.com](http://www.cree.com).

- **REACH Compliance**

REACH substances of high concern (SVHCs) information is available for this product. Since the European Chemical Agency (ECHA) has published notice of their intent to frequently revise the SVHC listing for the foreseeable future, please contact a Cree representative to insure you get the most up-to-date REACH SVHC Declaration. REACH banned substance information (REACH Article 67) is also available upon request.

- This product has not been designed or tested for use in, and is not intended for use in, applications implanted into the human body nor in applications in which failure of the product could lead to death, personal injury or property damage, including but not limited to equipment used in the operation of nuclear facilities, life-support machines, cardiac defibrillators or similar emergency medical equipment, aircraft navigation or communication or control systems, or air traffic control systems.