

# Electro-pneumatic control valves

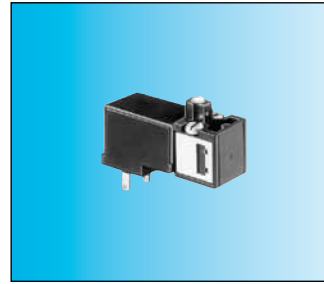

# Miniature solenoid valves for alternating current

- Conform to the Low Voltage Directive
- For mounting on sub-base or footprint in accordance with CNOMO recommendation E-06-36-120N



## Part numbers (and voltages)

Consumption	Voltage	81 519 080	81 519 380	81 519 680
2.5 VA	24 V ~ 50-60 Hz	—	81 519 381	—
2.5 VA	48 V ~ 50-60 Hz*	—	81 519 378	81 519 678
2.5 VA	110 V ~ 50-60 Hz	—	81 519 379	81 519 679
2.5 VA	220 V- 230 V ~ 50-60 Hz	—	—	—
Function		3/2 NC	3/2 NC	3/2 NC
Version		Without manual override	With manual override by impulse	With manual override by latching (1/4 turn)

## Characteristics

Operating pressure	bar	1 → 8	1 → 8	1 → 8
Orifice diameter	mm	0.5	0.5	0.5
Flow at 6 bars	NI/min	12	12	12
kV		0.12	0.12	0.12
Switching time	ms	5 → 15	5 → 15	5 → 15
Mechanical life (operations)		5 10 <sup>7</sup>	5 10 <sup>7</sup>	5 10 <sup>7</sup>
Operating temperature	°C	-10 → +50	-10 → +50	-10 → +50
Compressed air or inert gas - oil-free air filtered to 50 μ		●	●	●
Duty factor		100 % ED	100 % ED	100 % ED
Insulation class	IEC 85	F	F	F
Weight		35	35	35
Rotatable connector 4 positions in 90° steps		●	●	●
Degree of protection with sub-base (page 62)	IEC 529	IP 20	IP 20	IP 20
Degree of protection with connector 81 516 082 (page 65)	IEC 529	IP 65	IP 65	IP 65
UL and cUL approval		MH 15085	MH 15085	MH 15085

## 15x15 mm footprint

according to CNOMO E 06-36-120N

## Dimensions 81 519 0

81 519 3  
81 519 6

Manual override

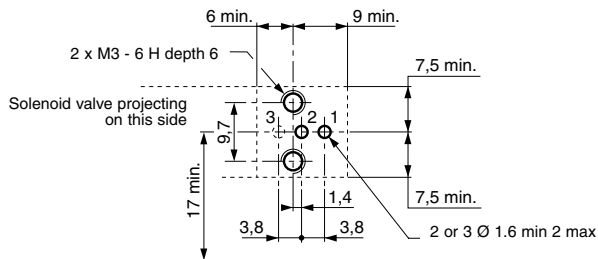

Adjacent side of footprint when valves mounted in bank

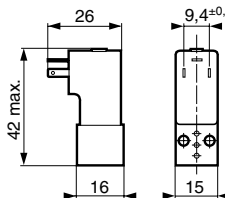

- 1 - Supply
- 2 - Output
- 3 - Exhaust

# Miniature solenoid valves for direct current

- Conform to the Low Voltage Directive
- For mounting on sub-base or footprint in accordance with CNOMO recommendation E-06-36-120N



Also available in ATEX version for use in potentially explosive atmospheres in accordance with 94/9/EC Directive

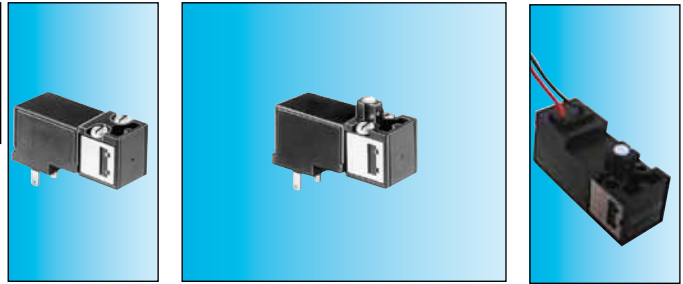

## Part numbers (and voltages)

	Consumption	Voltage	81 519 032	81 519 332	81 519 632	81 519 340
Function	1 W	24 V $\overline{\text{DC}}$	3/2 NC	3/2 NC	3/2 NC	3/2 NF
Version			Without manual override	With manual override by impulse	With maintained manual override	With maintained manual override

## Characteristics

Operating pressure	bar	1 → 8	1 → 8	1 → 8	1 → 8
Orifice diameter	mm	0.8	0.8	0.8	0.8
Flow at 6 bars	NI/min	25	25	25	25
kV		0.3	0.3	0.3	0.3
Switching time	ms	5 → 15	5 → 15	5 → 15	5 → 15
Mechanical life (operations)		5 10 <sup>7</sup>	5 10 <sup>7</sup>	5 10 <sup>7</sup>	5 10 <sup>7</sup>
Operating temperature	°C	-10 → +50	-10 → +50	-10 → +50	-10 → +50
Compressed air or inert gas - oil-free air filtered to 50 $\mu$		●	●	●	●
Duty factor		100 % ED	100 % ED	100 % ED	100 % ED
Insulation class	IEC 85	F	F	F	F
Weight		35	35	35	35
Rotatable connector 4 positions in 90° steps		●	●	●	●
Degree of protection with M12 5-pin connector	IEC 529	—	—	—	—
with connector 81 516 082	IEC 529	IP 65	IP 65	IP 65	IP 65
UL and cUL approval		MH 15085	MH 15085	MH 15085	MH 15085

## 15x15 mm footprint

according to CNOMO E 06-36-120N

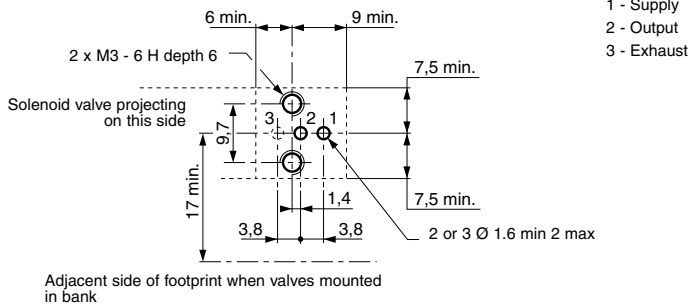

## Encombrement

81 519 0

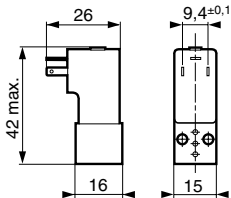

81 519 3  
81 519 6

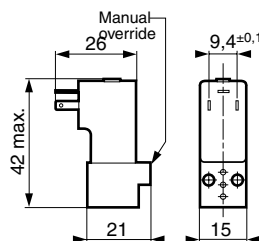

81 519 3

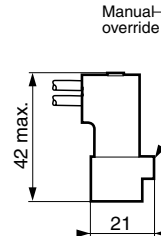

ATEX version products are available in the following catalogues: **Pneumatic products for explosive atmospheres** or on our website [www.crouzet.com](http://www.crouzet.com)

# Sub-bases for miniature solenoid valves



Also available in **ATEX** version for use in potentially explosive atmospheres in accordance with 94/9/EC Directive

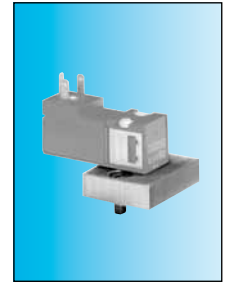
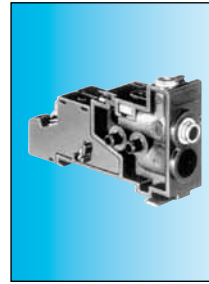
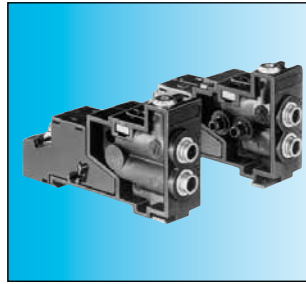

## Part numbers

Pair of end bases	<b>81 514 101</b>	—	—
Intermediate sub-base	—	<b>81 514 161</b>	—
Adaptor sub-base for CNOMO 06-05-80 / NFE 49066 footprint	—	—	<b>79 453 569</b>

## Characteristics

Pneumatic indicator on output	—	•	•	—
Common supply	—	•	•	—
Common exhaust	—	•	•	—
Torque capacity	mm <sup>2</sup>	3	3	—
Push-in connection for semi-rigid tubing Ø 4 mm (NFE 49100)	mm	•	•	—
Mounting		DIN rail 35 mm	DIN rail 35 mm	2 screws M4 x 10
UL and cUL approval	g	MH 15085	MH 15085	—
Weight		65	30	50

## Connection

Pneumatic

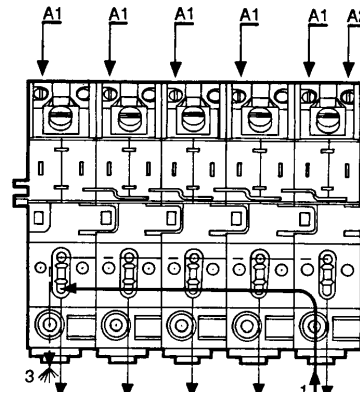

- 1 - Supply
- 2 - Output
- 3 - Exhaust

Electrical

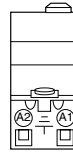

- A1 - Pilot signal
- A2 - Common
- ⊥ - Earth

**Dimensions** with miniature solenoid valve (page 58)

**81 514 101 - 81 514 161**

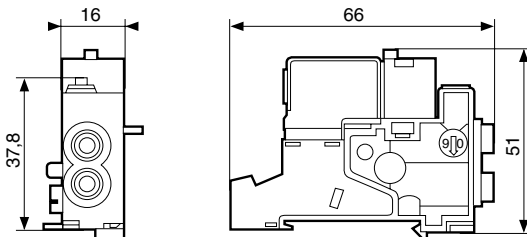

**79 453 569**

Connector ref 81 516 082  
(rotatable in 90° steps)  
see page 65

Miniature solenoid valve 81 519 ...  
see page 58

CNOMO footprint  
E 06-36-120N for mounting  
miniature solenoid valve 81 519

Mounting on CNOMO 06-05-80/  
NFE 49066 footprint

Fixing on CNOMO 06-05-80/  
NFE 49-066 footprint by  
2 cap screws M4x10  
(NFE 25-127)

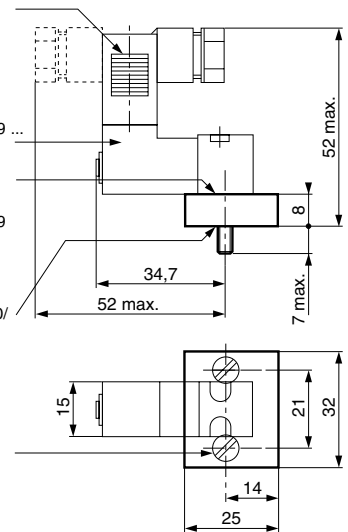

**ATEX** version products are available in the following catalogues: **Pneumatic products for explosive atmospheres** or on our website [www.crouzet.com](http://www.crouzet.com)

# Electro-pneumatic miniature control valves

## Mounting

### Miniature solenoid valves

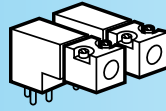

### Indicators

- LED seals
- LED

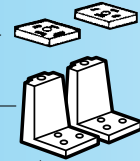

### Valve modules

- Poppet
  - 3/2 monostable (17.5 mm)
  - 4/2 monostable (17.5 mm)
- Slide valve
  - 4/2 bistable (35 mm)
  - 4/2 monostable spring-return (35 mm)

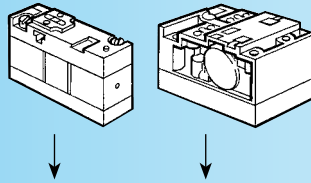

### Sub-bases

For miniature solenoid valves

For valve modules

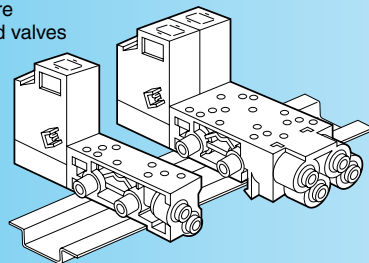

Single

Double

### Complete product

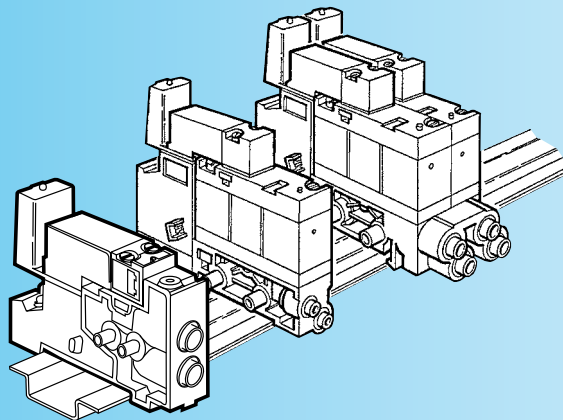

# Valve modules

- Monostable, bistable
- 3/2, 4/2



Also available in **ATEX** version for use in potentially explosive atmospheres in accordance with 94/9/EC Directive



81 513 100



81 513 600



81 513 200



81 516 200



81 516 100

Function	3/2 NC monostable	3/2 NO monostable	4/2 monostable	4/2 bistable	4/2 monostable
----------	-------------------	-------------------	----------------	--------------	----------------

### Symbol

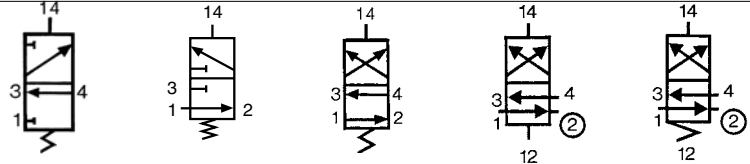

### Characteristics

Width	mm	17.5	17.5	17.5	35	35	
Working pressure	bars	3→8	3→8	3→8	2→8	3.5→8	
Orifice diameter	mm	3	3	3	4	4	
Flow at 6 bars	with Ø 4 mm sub-base (page 63)	200	200	200	300	300	
	with Ø 6 mm sub-base (page 63)	Nl/min	300	300	400	400	
Flow Rate	with Ø 4 mm sub-base (page 63)	kV	2.2	2.2	2.2	4	4
	with Ø 6 mm sub-base (page 63)		2.5	2.5	4	5	5
Operating temperature	°C	-10 → +50	-10 → +50	-10 → +50	-10 → +50	-10 → +50	
Switching time for the valve only	ms	15	15	15	50	50	
Mechanical life	operations	1.5 x 10 <sup>7</sup>	1.5 x 10 <sup>7</sup>	1.5 x 10 <sup>7</sup>	10 <sup>7</sup>	10 <sup>7</sup>	
Weight	g	38	38	38	106	106	

### Dimensions

#### 81 513

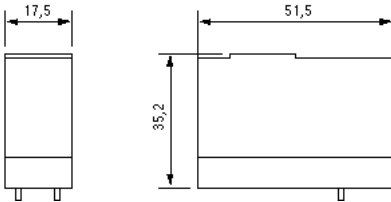

#### 81 516

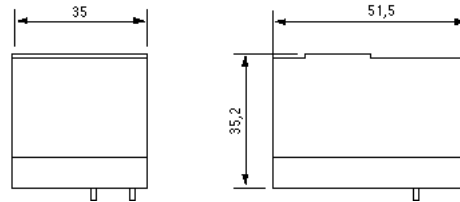

ATEX version products are available in the following catalogues: **Pneumatic products for explosive atmospheres** or on our website [www.crouzet.com](http://www.crouzet.com)

# Sub-bases and end bases for miniature control valves



Also available in **ATEX** version for use in potentially explosive atmospheres in accordance with 94/9/EC Directive

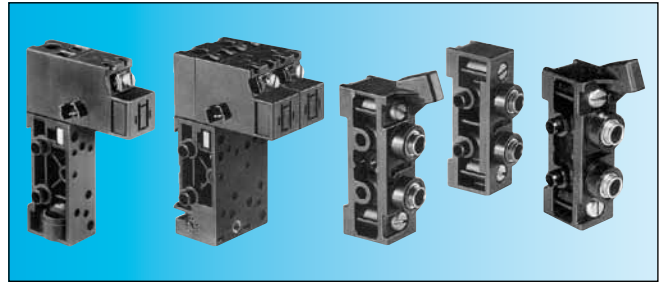

## Part numbers

Mounting		Cabinet	Cabinet	Cabinet	Cabinet
Version		17.5 mm	35 mm	—	—
Push-in connection for semi-rigid tubing (NFE 49100)	Sub-bases	Ø 4 mm	<b>81 513 060</b>	<b>81 517 101</b>	—
		Ø 6 mm	<b>81 513 065</b>	<b>81 517 201</b>	—
	End bases (pair)	Ø 6 mm	—	—	<b>81 513 011</b>
	Intermediate supply module	Ø 6 mm	—	—	—

## Characteristics

Torque capacity	mm²	3	3	—	—
UL and cUL approval		MM15085	MM15085	—	—
Mounting		DIN rail 35 mm	DIN rail 35 mm	DIN rail 35 mm	DIN rail 35 mm
Weight	g	55	110	86	44

## Connections

### Pneumatic



- 2 - Pneumatic output 4/2 (NO)
- 4 - Pneumatic output 3/2 or 4/2 (NC)

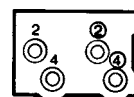

- ② Output at rest (NO)
- ② Output at rest \*
- ④ Output at rest \*
- 4 Output operating (NC)

### 81 513 011 - 81 513 001

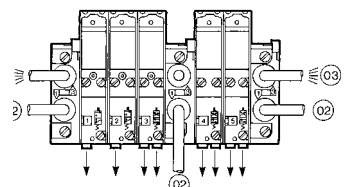

#### Note :

- Each sub-base can accept
- sub-base 81 513 060-065 : 1 relay 3/2 or 4/2, width 17.5 mm
- sub-base 81 517 101-201 : 1 bistable relay 4/2 (width 35 mm) or 2 relays 3/2 or 4/2 (width 17.5 mm)

② 2 Supply ports

③ 2 Exhaust ports

Integral push-in connections Ø 6 mm

### Electrical

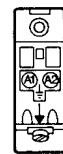

- A1 - Pilot signal
- A2 - Common



Earth

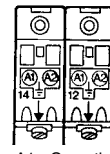

- A1 - Operating control signal (14)
- A2 - Common
- A1 - Rest control signal (12)
- A2 - Common



Earth

Degree of protection : IP20 when assembled.

**Dimensions** with miniature control valves (page 62) + miniature solenoid valves (page 58) + indicators (page 65)

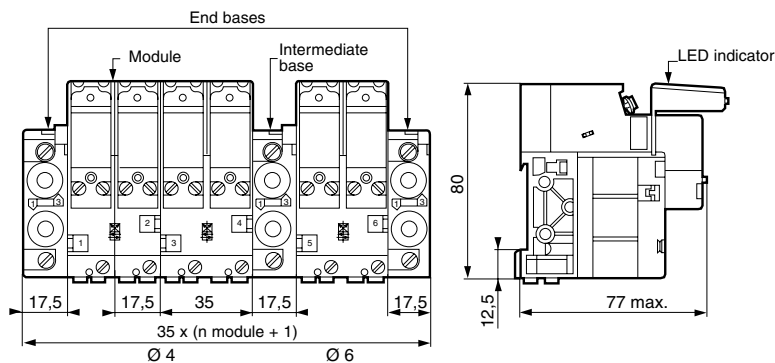

ATEX version products are available in the following catalogues: **Pneumatic products for explosive atmospheres** or on our website [www.crouzet.com](http://www.crouzet.com)

# Valves and solenoids valves assembled

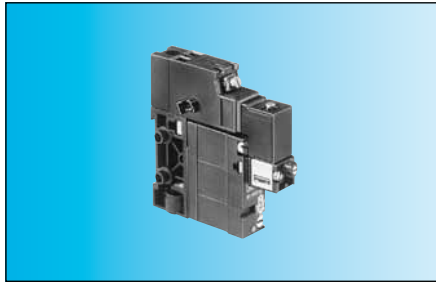

**Contact us for  
Other versions**

## Part numbers

Function	3/2 NC	4/2 monostable
Sub-base with push-in connection for semi-rigid tubing (NFE 49100)	Ø 4 ext.	Ø 4 ext.
Version	Solenoid valve with manual override by impulse	Solenoid valve with manual override by impulse
Voltage	24 VDC (+10% -15%)	81 513 103
		81 513 203

## Symbol



## Characteristics

Operating pressure	bar	3→8	3→8
Orifice diameter	mm	3	3
Flow at 6 bars	NL/min	200	200
KV		2.2	2.2
Operating temperature	°C	-10 → +50	-10 → +50
Switching time of the assembly	ms	20	20
Mechanical life (operations) at 4 bars		1.5 x 10 <sup>7</sup>	1.5 x 10 <sup>7</sup>
Valve position will be maintained in the event of pressure loss and/or electrical current loss		—	—
Mounting		DIN rail 35 mm	DIN rail 35 mm
Weight	g	130	130
UL and cUL approval		MH15085	MH15085

## Principle of operation

## Dimensions

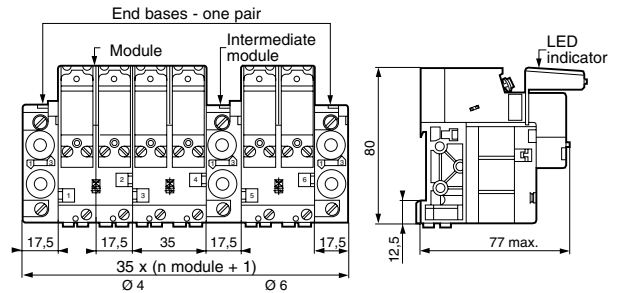
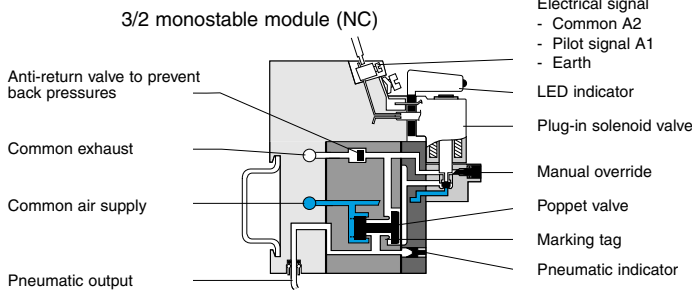

4/2 monostable module

4/2 bistable module

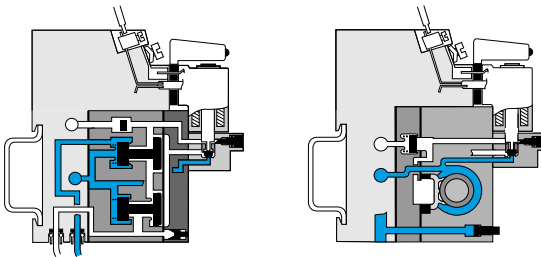

End bases not supplied (page 63)  
Intermediate bases not supplied (page 63)  
Indicators not supplied (page 65)



# Accessories



Also available in **ATEX** version for use in potentially explosive atmospheres in accordance with 94/9/EC Directive

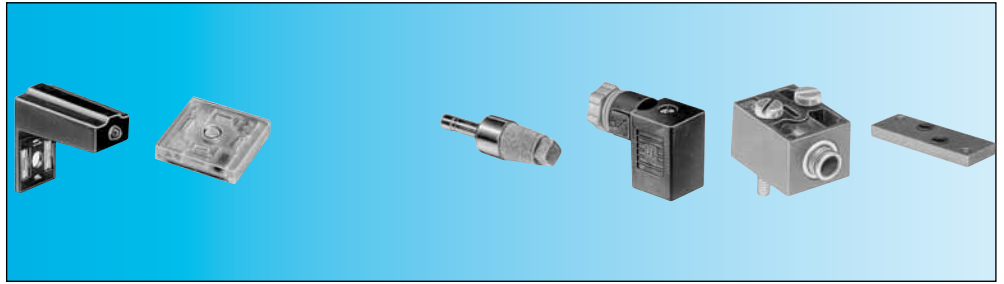

## Part numbers

Visual indicators with anti-surge	24 V - 50-60 Hz $\overline{\text{---}}$	81 513 052	—	—	—	—	—	—
	48 V - 50-60 Hz $\overline{\text{---}}$	81 513 055	—	—	—	—	—	—
	110 V - 50-60 Hz $\overline{\text{---}}$	81 513 058	—	—	—	—	—	—
	230 V - 50-60 Hz (-10% +6 %)	81 513 059	—	—	—	—	—	—
LED seal Packaging	12 to 24 V - DC - AC (by 5)	—	81 513 064 (by 10)	—	—	—	—	—
Exhaust silencer	Plug-in $\varnothing$ 6	—	—	81 537 001	—	—	—	—
Connector for solenoid valve	Plug-in $\varnothing$ 8	—	—	81 537 201	—	—	—	—
	Without manual override	—	—	—	81 516 082	—	—	—
Pneumatic pilots	With manual override by impulse	—	—	—	—	81 516 081	—	—
		—	—	—	—	81 516 091	—	—
Push-in connection for semi-rigid tubing $\varnothing$ 4 mm (NFE 49100)		—	—	—	—	—	•	—
Blanking plate		—	—	—	—	—	—	81 516 085

## Symbol

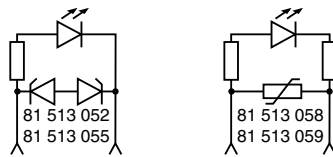

## Characteristics

Consumption	W	—	0.24	—	—	—	—	—
Temperature	$^{\circ}\text{C}$	—	- 10 $\rightarrow$ +50	—	—	—	—	—
Connection	mm	—	—	—	—	—	Instantané $\varnothing$ 4 ext.	—
Mounted between the pilot solenoid valve and the body of the module		•	•	—	—	—	—	—
Supplied in multiples of 5		•	—	—	—	—	—	—
Supplied in multiples of 10		—	•	—	—	•	•	•
Packet of 10 pieces		—	—	—	—	—	—	•
Weight	g	6	2	30	10	5	3	—

## Connection

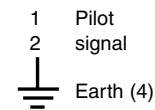

## Dimensions

### 81 537 001 - 81 537 201

Mounted by plugging into push-in connector for semi-rigid tubing (NFE 49100)

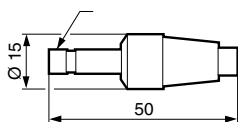

### 81 513 052 - 81 513 055

### 81 513 058 - 81 513 059

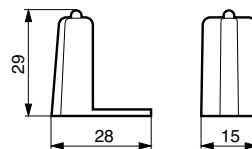

### 81 516 082

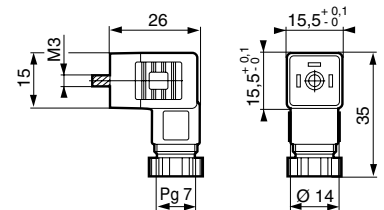

ATEX version products are available in the following catalogues: **Pneumatic products for explosive atmospheres** or on our website [www.crouzet.com](http://www.crouzet.com)

# Solenoid valves

- Reduced "dimensions"
- Mounted on sub-base

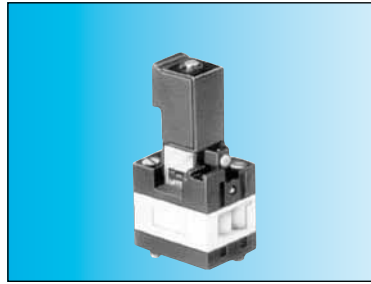

## Part numbers and voltages

Function		3/2 NC	
Mounting		On sub-base (54)	
Solenoid valves	24 V (+10% -15%)	81 519 732	
with	24 V - 50/60 Hz (+10% -15%)	81 519 774	
manual	48V - 50/60 Hz (+10% -15%)	81 519 775	
override	110 V - 50/60 Hz (+10% -15%)	81 519 776	
by impulse	220 - 230 V - 50/60 Hz (+10% -15%)	81 519 777	

## Symbol

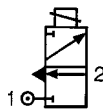

## Characteristics

Operating pressure	bar	2 → 8	
Orifice diameter	mm	2.7	
Flow at 6 bars	NI/min	170	
Rotatable coil 4 positions in 90° steps		●	
Degree of protection (with connector 81 516 082 not supplied) (see page 65)	IEC 529	IP 65	
Mechanical life	operations	1.5 x 10 <sup>7</sup>	
Consumption	W	1	
	VA	2.5	
Operating temperature	°C	-5 → +50	
Weight	g	70	
UL and cUL approval		MH15085	

## Principle of operation

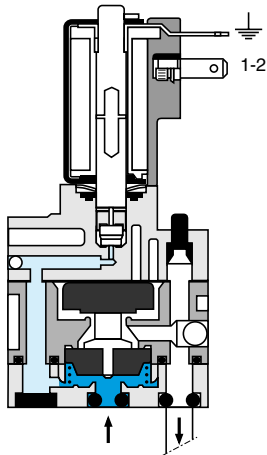

## Connections

- Pneumatic { 1 - Supply  
2 - Output
- Electrical { 1 - 2 - Pilot signal  
⊥ Earth

Electrical connection by connector 81 516 062 (see page 65)

## Dimensions

81 519

On separate sub-base

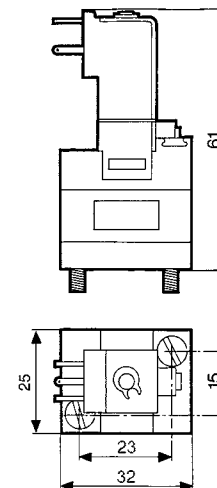

5

## ► Specific islands "for integrators" (supplied in packs of 20)

### ► Versions with interfaces 300 NL / mm



#### Configuration

- 1 - Specify the number and type of interfaces (3 / 2 mono - 4 / 2 mono - 4 / 2 bistable) see page 62.
- 2 - Specify the voltage, the type and method of the control valve connections, see page: 58-59 (Example: 24 V DC with manual switch maintained, exit leads).
- 3 - Please send us your application specifying your requirements and quantities per year, and we will respond as soon as possible.

### ► Versions with interfaces 30 NL / mm



#### Configuration

- 1 - Specify the voltage, the type and method of the control valve connections, see page: 58-59 (Example: 24 V DC with manual switch maintained, exit leads).
- 2 - Please send us your application specifying your requirements and quantities per year, and we will respond as soon as possible.

### ► Develop customised versions to specifications



Crouzet analyses your needs and offers a customised solution.

