

# Pneumatic logic components

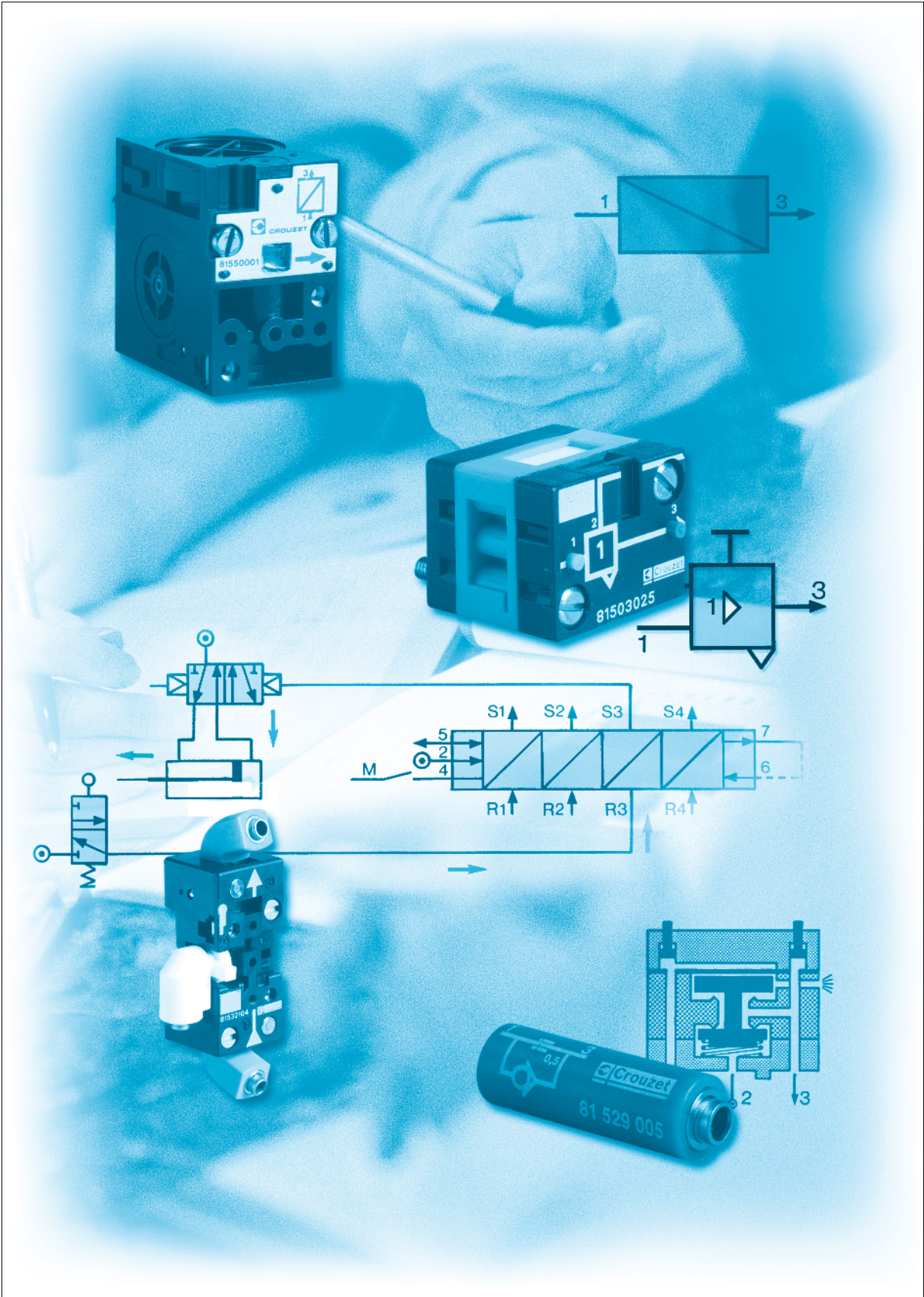

# General characteristics

## Operating fluid

- Compressed air or inert gas.

## Conditions of use

- Operating pressure 2 at 8 bars (except for special conditions).
- Fluid: Filtered air to 50 microns - non lubricated.
- Operating temperature from - 5° C to + 50° C (under + 5° C the dew point must be below 10° C for the application).
- For optimum performance, the elements should be inter-connected by air supply tubing with an internal diameter  $\geq$  at 2.5 mm.

## Mounting recommendations

- The elements should be mounted and piped in a clean atmosphere in order to prevent any form of pollution entering the system.
- Minimum torque for element fixing screws: 5 cm/kg.
- maximum torque for element fixing screws: 10 cm/kg.

## Characteristics common to all elements in the modular system

- The characteristics have been obtained with a supply pressure at 6 bars.
- The flow in NI/min is the number of litres of air at normal atmospheric pressure obtained with the output open to atmosphere and the supply pressure at 4 bars
- The consumption in NI/min is the number of litres of free air necessary for the unit to function.
- kV = the flow coefficient of the equipment.
- Mechanical life > 10<sup>7</sup> operations.

## flow graphs

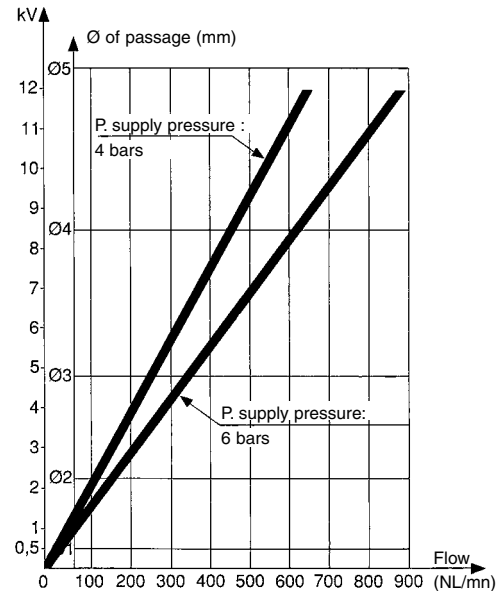

## Sequencer modules

Operation results from the combination of a sequential cycle. A system comprises individual modules which are joined together by means of a sub-base. Each module has a memory which delivers an output signal and receives an input signal.

An indicator on each module allows the operator to monitor the progress of the cycle and identify quickly and easily any fault which may occur.

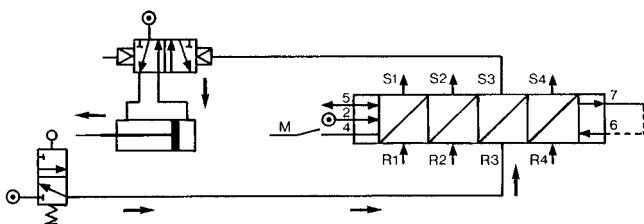

Operation results from the combination of three functions (memory, AND and OR) which constitute each module.

The memory activates the output and gives priority to the reset signal. The AND element ensures the transition to the next module but only if an input signal is present.

The OR element ensures the resetting of all previously operated modules

## Function diagram

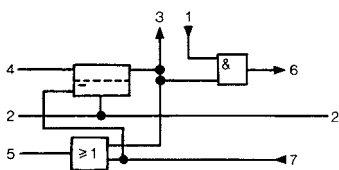

## sequencer module with maintained reset

### Brake

This maintains the memory spool in position only when the supply is lost.

## Module with auto reset

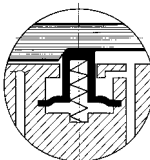

### Brake

This returns the memory spool to the reset condition only when the supply is lost

### Shift register

The general principle is to advance the sequencer step by command impulses to the inputs of the even steps, alternating with the command impulses to the inputs of the odd steps.

Used for example on a transfer machine to shift the information "bad component" collected at a test-test "n" steps further along the machine to a reject station.

## Function diagram

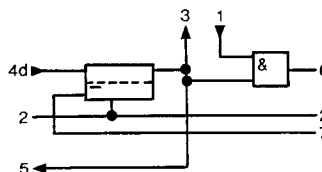

## Auto reset sequencer module

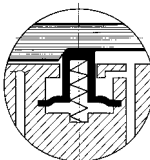

# Sequencer modules

- 100 % pneumatic
- Ideal for a simple pneumatic sequence



Also available in **ATEX** version for use in potentially explosive atmospheres in accordance with 94/9/EC Directive

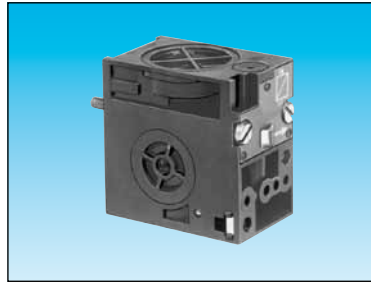

81 550 001  
with 'maintain'

81 550 201  
Reset to zero

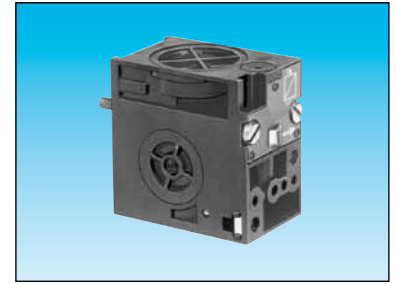

81 550 401  
with 'maintain'

81 550 601  
Reset to zero

Versions sequencer  
shift register

## Symbol



## Characteristics

	bar	2 → 8	2 → 8	2 → 8	2 → 8
Operating pressure	bar	2 → 8	2 → 8	2 → 8	2 → 8
Orifice diameter	mm	2.7	2.7	2.7	2.7
Flow at 6 bars	NI/min	150	150	150	150
Operating temperature	°C	-5 → +50	-5 → +50	-5 → +50	-5 → +50
Mechanical life 5 x 10 <sup>6</sup> at 6 bars		●	●	●	●
Connection - Sub-base page 26		●	●	●	●
Weight	g	70	70	70	70

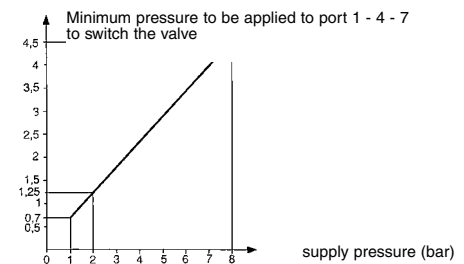

## Principle of operation

(supplied without logic element. For choice of units see pages 46/47)

### Sequencer module with maintained reset

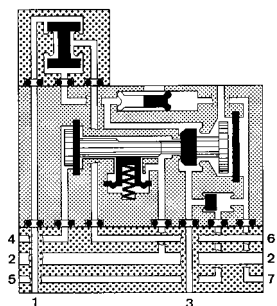

- 1 - Input signal
- 2 - Supply
- 3 - Output signal
- 4 - Start signal
- 5 - In cycle signal
- 6 - End of cycle signal
- 7 - Reset to zero signal

### Shif register with maintained reset

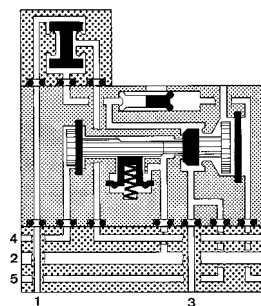

- 1 - Input signal
- 2 - Supply
- 3 - Output signal
- 4 - Start signal
- 5 - In cycle signal
- 6 - End of cycle signal
- 7 - Reset to zero signal

## Dimensions

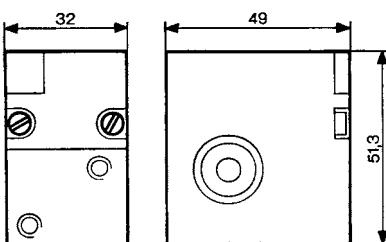

## Mounting plan for sequencer

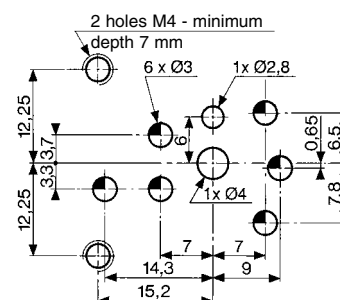

ATEX version products are available in the following catalogues: **Pneumatic products for explosive atmospheres** or on our website [www.crouzet.com](http://www.crouzet.com)



# Sequencer sub-bases



Also available in **ATEX** version for use in potentially explosive atmospheres in accordance with 94/9/EC Directive

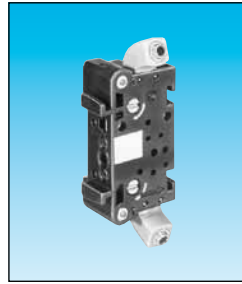

81 551 101  
Sub-base (DIN oméga)



81 552 101  
End bases - one pair

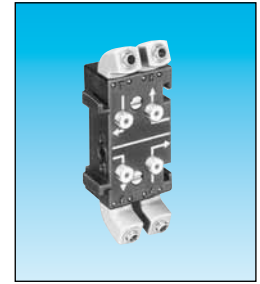

81 552 601  
Diversion base

Versions Front connecting (DIN-omega)  
Rear connecting (with clips)

## Characteristics

Sub-bases (fitted)	Rotatable connectors			
	Pressure indicators			
Operating temperature	°C	-5 → +50	-5 → +50	-5 → +50
Weight	g	55	135	60

## Sequencer connections

### Front connecting

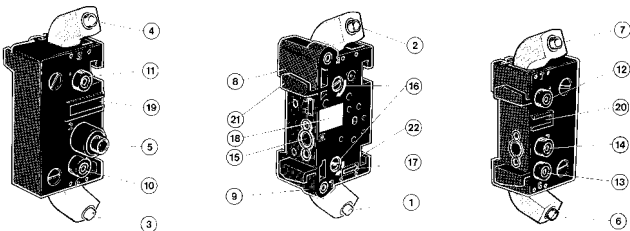
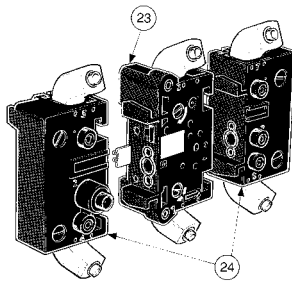

- 1 - Input port (green port 1) Ø 4
- 2 - Output port (red port 1) Ø 4
- 3 - Input port, cycle start (green port 1) Ø 4
- 4 - Output port, in-cycle signal (red port 1) Ø 4
- 5 - Output port, cycle end (red port 6) Ø 4
- 6 - Output port, cycle end (red port 6) Ø 4
- 7 - Input port, reset to zero (green port 7) Ø 4
- 8 - Output indicator (red)
- 9 - Input indicator (green)
- 10 - Cycle start indicator at port 4 (green)
- 11 - In-cycle indicator at port 5 (red)
- 12 - Input indicator at port 7 (green)
- 13 - End of cycle indicator at port 6 (red)
- 14 - Supply indicator at port 2 (yellow)
- 15 - Interconnecting ports
- 16 - Fixing screws
- 17 - Engraved arrow to indicate direction of sequence
- 18 - Marking tag
- 19 - Marking tag position
- 20 - Marking tag position
- 21 - Mounting tongue
- 22 - Mounting groove
- 23 - Sub-base
- 24 - End bases

## Dimensions

### Front connecting

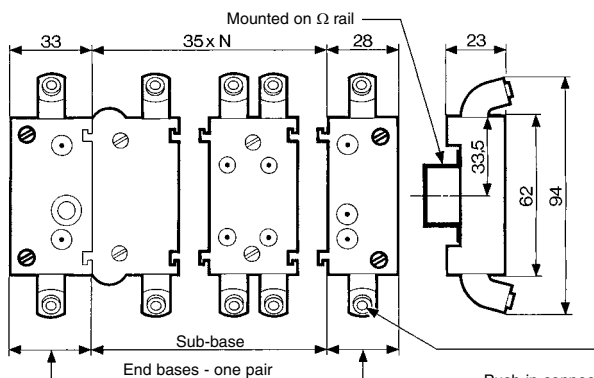

Push-in connection for semi-rigid tube  
Ø 4 mm (NFE 49100)

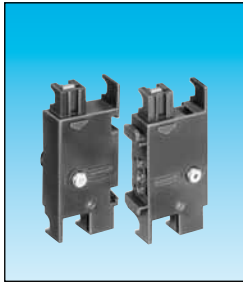
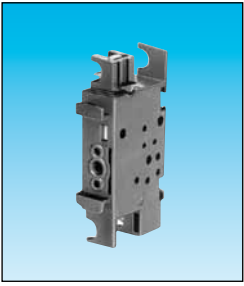

81 551 001

Sub-base (with clips)

81 552 001

End bases - one pair

-5 → +50  
40

-5 → +50  
120

**Rear connecting**

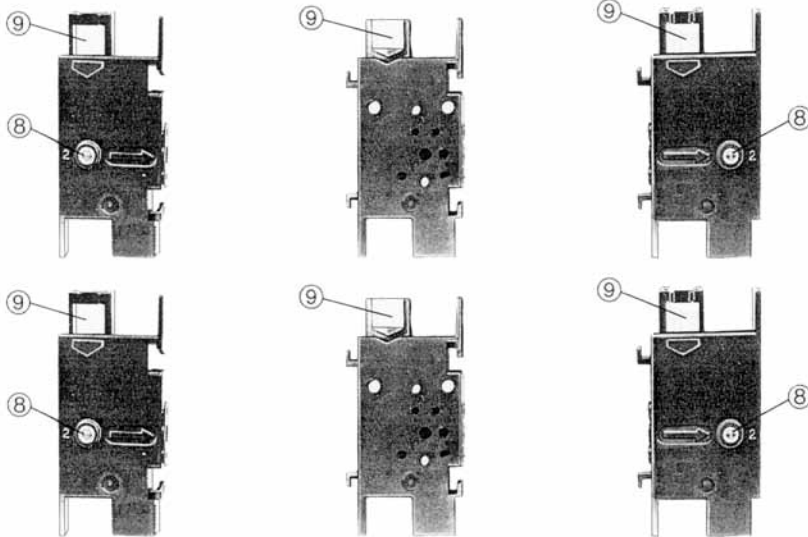

- 1 - Input port (marked port 1)
- 2 - Supply port (Port 2)
- 3 - Output port (Port 3)
- 4 - Cycle start signal port (Port 4)
- 5 - In-cycle signal port (Port 5)
- 6 - End of cycle signal port (Port 6)
- 7 - Reset to zero signal port (Port 7)
- 8 - Indicator at supply port
- 9 - Marking area

**Rear connecting**

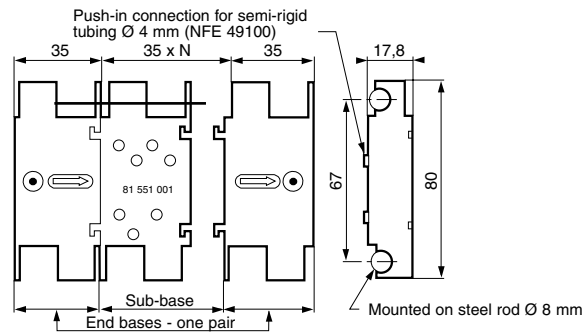

ATEX version products are available in the following catalogues: **Pneumatic products for explosive atmospheres** or on our website [www.crouzet.com](http://www.crouzet.com)

# Logic elements

- Performs "combined" Pneumatic
- Easy to use



Also available in **ATEX** version for use in potentially explosive atmospheres in accordance with 94/9/EC Directive

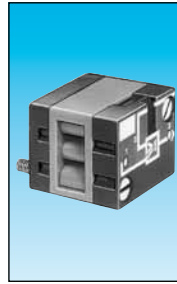

Functions	OR	81 521 501	81 540 001	81 540 005	81 522 501
	AND	—	—	—	—
	YES	—	—	—	—
	NO	—	—	—	—
Version		On Sub-base page 4/14-4/15	Plug-in Ø 4	Plug-in Ø 6	On Sub-base page 4/14-4/15

## Symbol

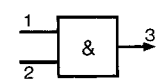
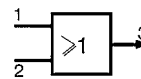

## Characteristics

Push-in connection for semi-rigid tubing (NFE 49100)	Male/Female/Female	—	Ø 4 mm	—	—
	Female/Female/Female	—	—	Ø 6 mm	—
Colour		Blue	Blue	Blue	Green
Operating pressure	bar	2 → 8	2 → 8	2 → 8	2 → 8
Orifice diameter	mm	2.7	2.7	4	2.7
Flow at 6 bars	NI/min	170	170	200	170
Pressure indicator		●	—	—	●
Switching time	ms	—	—	—	—
Operating temperature	°C	-5 → +50	-5 → +50	-5 → +50	-5 → +50
Mechanical life	operations	>10 <sup>7</sup>	>10 <sup>7</sup>	>10 <sup>7</sup>	>10 <sup>7</sup>
Weight	g	25	12	25	25

## Pilot/pressure curves

P<sub>p</sub> : Pilot pressure  
P<sub>a</sub> : Supply pressure

## Principle of operation

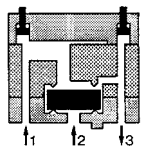

### Cellule OR

The output signal "S" is present when a signal at "a" OR "b" is present:

$$S = a \text{ OR } b$$

$$S = a + b$$

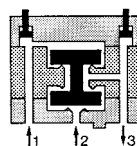

### Cellule AND

The output signal "S" is present only when signals "a" AND "b" are present simultaneously:

$$S = a \text{ AND } b$$

$$S = a \cdot b$$

## Dimensions

81 521 501 - 81 522 501

81 540 005 - 81 541 005

81 540 001 - 81 541 001

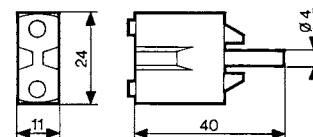
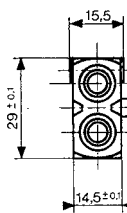
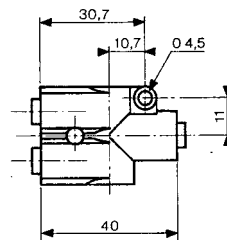
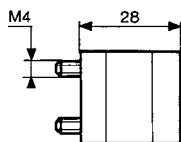
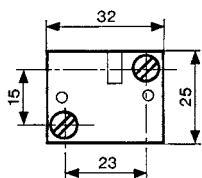

## Other information

See pages 54/55 for mounting plan for logic elements.

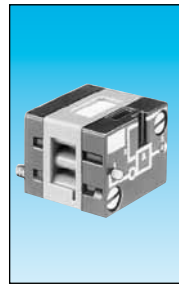
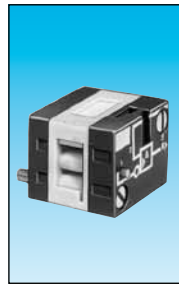
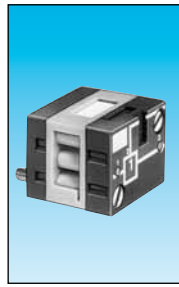
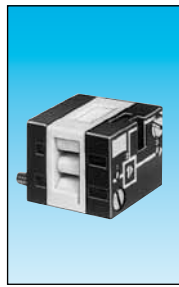

81 541 001

81 541 005

81 501 025

81 503 025

81 504 025

81 506 025

Plug-in  
Ø 4

Plug-in  
Ø 6

On sub-base  
page 36-37

Threshold  
On sub-base page  
4/14-4/15

Threshold  
On sub-base page  
4/14-4/15

Threshold  
On sub-base page  
4/14-4/15

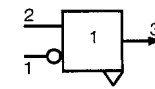
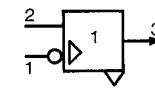
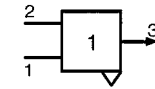
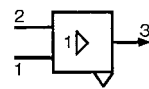
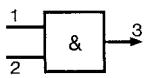

Ø 4 mm

Ø 6 mm

Green

Green

Yellow

Orange

Light grey

Dark grey

2 → 8

2 → 8

2 → 8

2 → 8

2 → 8

2 → 8

2.7

4

2.7

2.7

2.7

2.7

150

200

170

170

170

170

< 4

< 4

< 4

< 4

< 4

< 4

-5 → +50

-5 → +50

-5 → +50

-5 → +50

-5 → +50

-5 → +50

>10<sup>7</sup>

>10<sup>7</sup>

>10<sup>7</sup>

>10<sup>7</sup>

>10<sup>7</sup>

>10<sup>7</sup>

13

25

30

30

30

30

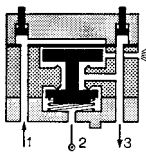
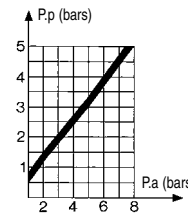
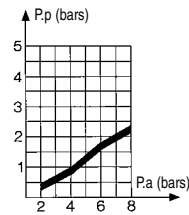
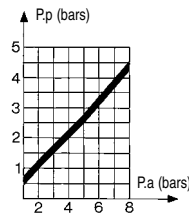
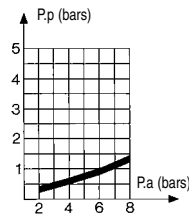

**YES element**

The output signal "S" is only present when the pilot is present "a" is present:

$S = a \text{ YES } b$

$S = a$

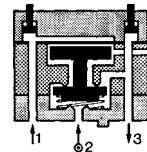

**NOT element**

The output signal "s" is present only if the input signal "a" is NOT present. The output signal is therefore the inverse of the pilot signal:

$S = \text{NOT } a$

$S = \bar{a}$

If the supply port is connected to a 2nd input "b", the function obtained is called inhibition:

$S = \text{NOT } a \text{ AND } b$

$S = \bar{a} \cdot b$

81 501 025 - 81 503 025

81 504 025 - 81 506 025

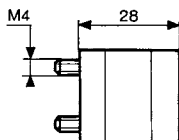
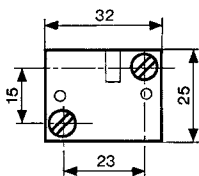

ATEX version products are available in the following catalogues: **Pneumatic products for explosive atmospheres** or on our website **www.crouzet.com**

# Memory element

- 100 % pneumatic
- Bistable pneumatic



Also available in **ATEX** version for use in potentially explosive atmospheres in accordance with 94/9/EC Directive

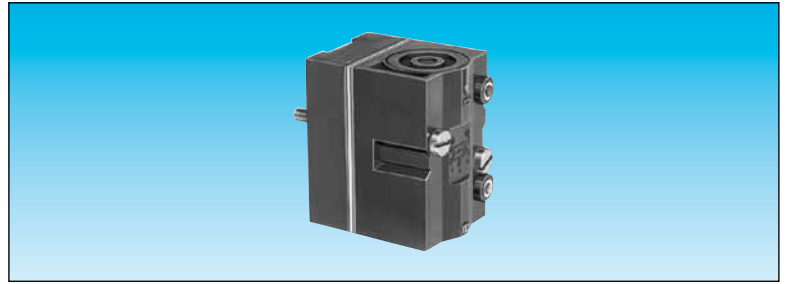

Version

**81 523 201**  
With pressure indicator

**81 523 601**  
With pressure indicator and manual override

## Symbol

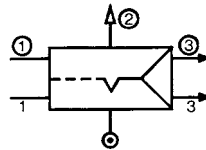

## Characteristics

Colour		Black	Black
Operating pressure	bar	2 → 8	2 → 8
Orifice diameter	mm	2.7	2.7
Minimum memory pilot pressure	bar	2.5	2.5
Operating temperature	°C	-5 → +50	-5 → +50
Flow at 6 bars	NI/min	200	200
Connection - On sub-base page		4/14-4/15	4/14-4/15
Weight	g	90	90

## Principle of operation

The function is that of a 4/2 valves. The appearance of signal "X1" causes the displacement of the slide valve. The output port "x" is then put under pressure. This state is remembered until the arrival of signal "X0". This signal reverses the slide valve, the output "x" is put under pressure. This state is likewise remembered. The output:

- "x" under pressure indicates that the information in the MEMORY is "X1",
- "x" under pressure indicates that the information in the MEMORY is "X0".

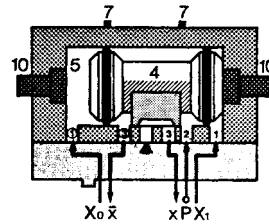

## Dimensions

81 523 201 - 81 523 601

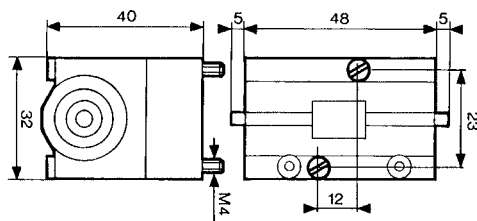

## Dimensions of logic and memory elements

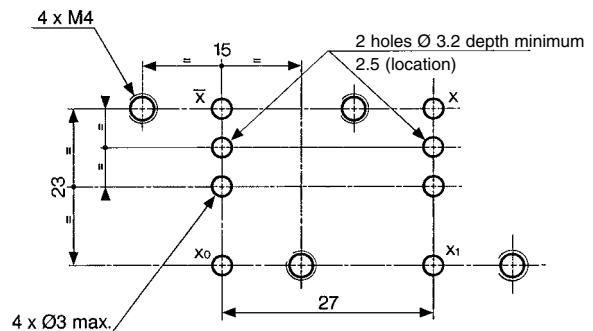

Viewed from above

ATEX version products are available in the following catalogues: **Pneumatic products for explosive atmospheres** or on our website [www.crouzet.com](http://www.crouzet.com)



# Timers fixed timing

## ■ Fixed 0.4 s



Also available in **ATEX** version for use in potentially explosive atmospheres in accordance with 94/9/EC Directive

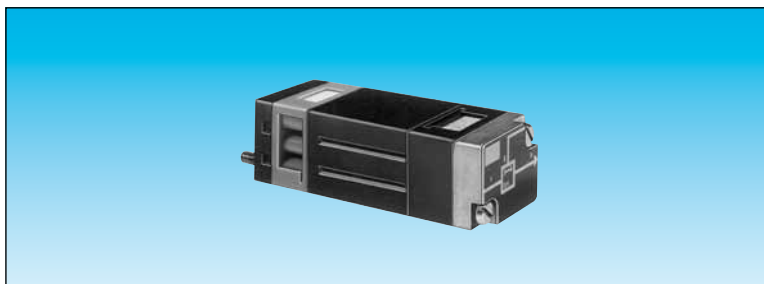

81 503 540  
Positive output

Version

### Symbol

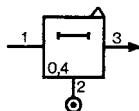

### Characteristics

Timing	s	0.4
Operating pressure	bar	2 → 8
Flow at 6 bars	NI/min	170
Orifice diameter	mm	2.7
Accuracy	%	± 5
Min. reset time	s	<0.1
Connection - On sub-base page 36-37		●
Operating temperature	°C	-5 → +50
Mechanical life	operations	>10 <sup>7</sup>
Weight	g	106

### Principle of operation with positive output

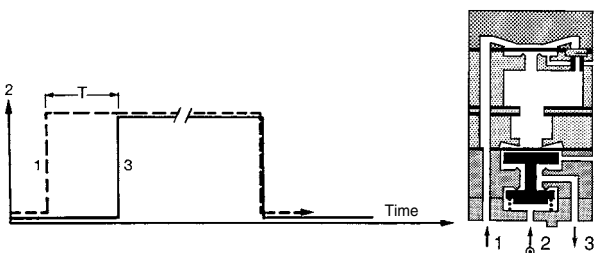

### Dimensions

81 503 540

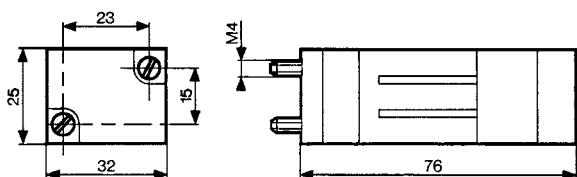

ATEX version products are available in the following catalogues: **Pneumatic products for explosive atmospheres** or on our website [www.crouzet.com](http://www.crouzet.com)

# Timers (with adjustable timing)

■ 60 s adjustable (60 s max.)



Also available in **ATEX** version for use in potentially explosive atmospheres in accordance with 94/9/EC Directive



81 503 710

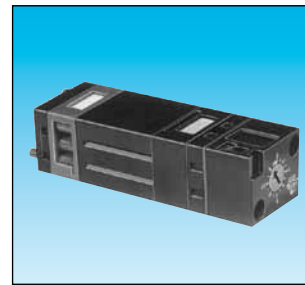

81 506 710



81 503 720

81 506 720

81 503 725

81 506 725

Function positive negative

•

—

•

—

•

—

## Symbol

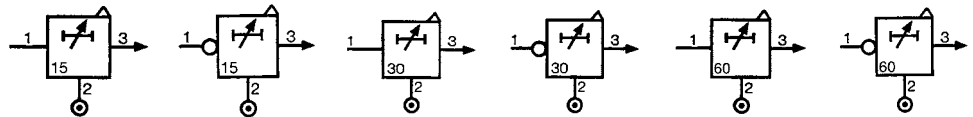

## Characteristics

Timing	s	0.1 → 15	0.1 → 15	0.1 → 30	0.1 → 30	0.1 → 60	0.1 → 60
Operating pressure	bar	2 → 8	2 → 8	2 → 8	2 → 8	2 → 8	2 → 8
Flow at 6 bars	NI/min	170	170	170	170	170	170
Orifice diameter	mm	2.7	2.7	2.7	2.7	2.7	2.7
Accuracy	%	± 5	± 5	± 5	± 5	± 5	± 5
Min. reset time	s	<0.1	<0.1	<0.1	<0.1	<0.1	<0.1
Connection - On sub-base page 4/14-4/15		•	•	•	•	•	•
Operating temperature	°C	-5 → +50	-5 → +50	-5 → +50	-5 → +50	-5 → +50	-5 → +50
Mechanical life	operations	>10 <sup>7</sup>	>10 <sup>7</sup>	>10 <sup>7</sup>	>10 <sup>7</sup>	>10 <sup>7</sup>	>10 <sup>7</sup>
Weight	g	90	90	100	100	120	120

## Accessories

Panel mounting adaptor		79 451 698	79 451 698	79 451 903	79 451 903	—	—
Weight	g	53	53	53	53	—	—

## Principle

The operation of these pneumatic timers is similar to that of electronic timers (circuit with capacitor/resistor)

## Principle of operation

with positive output

with negative output

## Timing by charging of reservoir

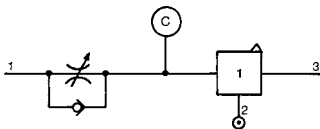

The reservoir fills via the flow restrictor until the switching point of the timer output is reached (positive or negative). The non-return valve allows the reservoir to be emptied rapidly for the next timing.

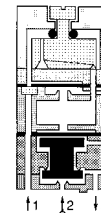
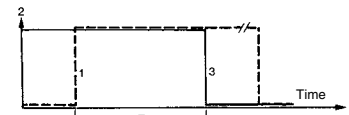
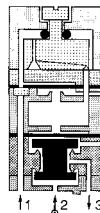
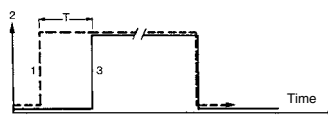

## Dimensions

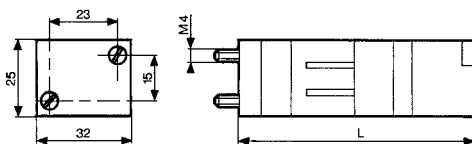

	L (mm)
81 503 710 - 81 506 710	78
81 503 720 - 81 506 720	92
81 503 725 - 81 506 725	125

## Adaptator 79 451 ...

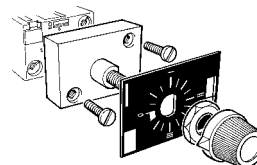
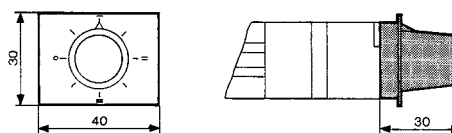

For panel mounting, a pre-drilled hole Ø 10.5 mm is required

ATEX version products are available in the following catalogues: **Pneumatic products for explosive atmospheres** or on our website [www.crouzet.com](http://www.crouzet.com)

# Timers

## ■ Fixed and adjustable



Also available in **ATEX** version for use in potentially explosive atmospheres in accordance with 94/9/EC Directive

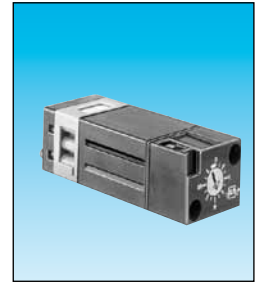
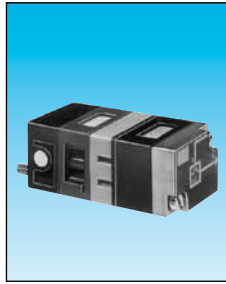

Single impulse generator	Fixed	81 507 540	—	—
	Adjustable	—	81 507 720	—
Adjustable frequency generator	—	—	—	81 506 940

### Symbol

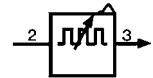
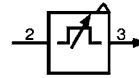
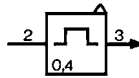

### Characteristics

Timing	s	0.4	0.1 → 30	—
Frequency	Hz	—	—	0.02 → 8
Operating pressure	bar	2 → 8	2 → 8	2 → 8
Flow at 6 bars	Nl/min	170	170	170
Orifice diameter	mm	2.7	2.7	2.7
Accuracy	%	± 5	± 5	± 5
Min. reset time	s	<0.1	<0.1	<0.1
Connection - On sub-base page 4/14-4/15		●	●	●
Operating temperature	°C	-5 → +50	-5 → +50	-5 → +50
Mechanical life	operations	>10 <sup>7</sup>	>10 <sup>7</sup>	>10 <sup>7</sup>
Weight	g	106	180	85

### Accessories

Panel mounting adaptators	—	79 451 904	79 451 905
Weight (g)	—	53	53

### Principle of operation

Single impulse generator

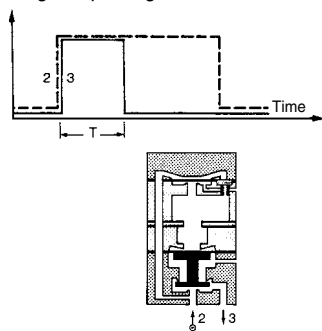

Adjustable impulse generator

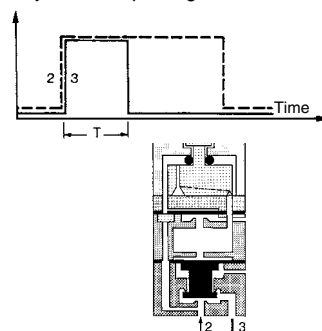

Frequency generator

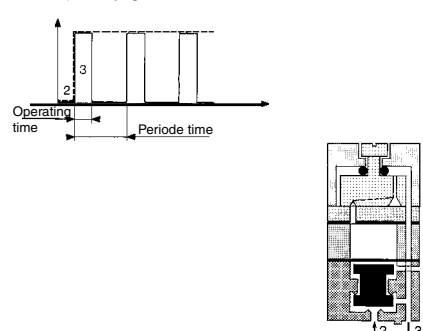

### Dimensions

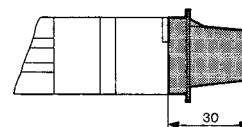
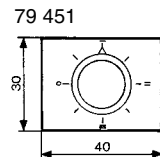
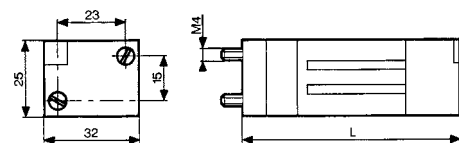

Part numbers	L (mm)
81 507 540	73
81 507 720	99
81 506 940	72

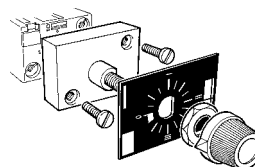

For panel mounting, a pre-drilled hole Ø 10.5 mm si required

ATEX version products are available in the following catalogues: **Pneumatic products for explosive atmospheres** or on our website [www.crouzet.com](http://www.crouzet.com)

# Timing Accessories



Also available in **ATEX** version for use in potentially explosive atmospheres in accordance with 94/9/EC Directive

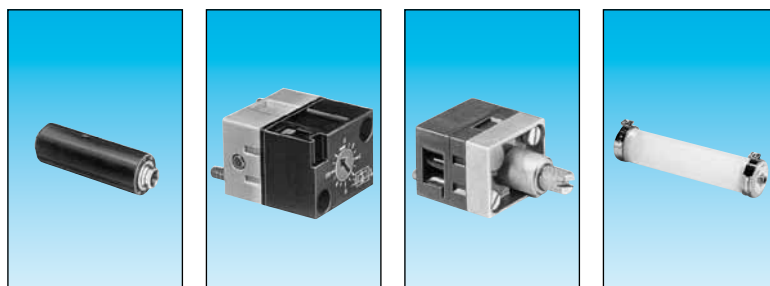

One-way in-line fixed flow restrictors	Flow at 4 bars Nm <sup>3</sup> /h	Ø orifice (mm)				
	0.18 → 0.30	0.3	white	81 529 003	—	—
	0.35 → 0.50	0.4	yellow	81 529 004	—	—
	0.58 → 0.77	0.5	red	81 529 005	—	—
	0.80 → 1.06	0.6	green	81 529 006	—	—
	1.10 → 1.39	0.7	blue	81 529 007	—	—
	1.45 → 1.65	0.8	grey	81 529 008	—	—
	2.30 → 2.80	1	black	81 529 010	—	—
	0.08 → 0.12	0.25	white	81 529 025	—	—
One-way adjustable flow restrictor					81 525 101	81 526 001
Capacity for timing	10 • 60 s				—	—
						79 458 808

## Symbol

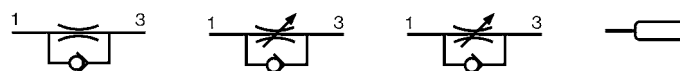

## Characteristics

Free flow	Nl/min	Depending on orifice	30	200	—
Orifice diameter	mm	Depending on orifice	0 → 0.5	0 → 1.7	—
Operating pressure	bars	1 → 8	1 → 8	2 → 8	—
Timing	s	—	—	—	10 → 60
Capacity	cm <sup>3</sup>	—	—	—	30
Connection	Sub-base page 4/14-4/15 Push-in connection for semi-rigid tubing (NFE 49100)	mm	Ø 4	—	Ø 4
Operating temperature	°C	-5 → +50	-5 → +50	-5 → +50	-5 → +50
Weight	g	8	60	70	40

## Connections

- For timing circuit
  - One-way flow restrictor 81 525 1 - 81 529 0 (1)
  - Reservoir 79 458 018 (2)
  - Relay element 81 503 0 - 81 506 0 (3) page 4/6-4/7
- Sub-base page 4/14-4/15

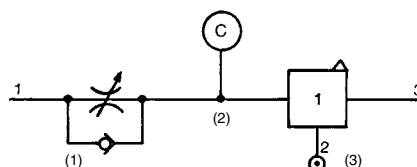

## Principle of operation

One-way  
with fixed flow

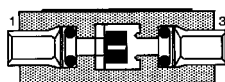

One-way  
with adjustable flow

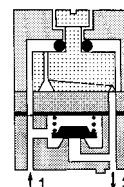

## Dimensions

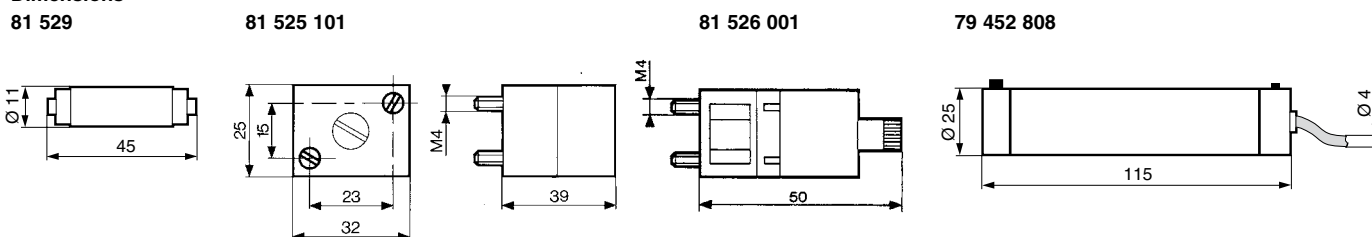

ATEX version products are available in the following catalogues: **Pneumatic products for explosive atmospheres** or on our website [www.crouzet.com](http://www.crouzet.com)

# Regulator accessories



Also available in **ATEX** version for use in potentially explosive atmospheres in accordance with 94/9/EC Directive

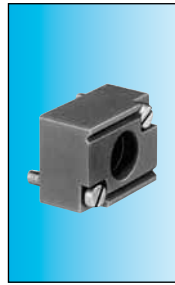

## Part numbers

Mini-détenteur	81 527 001	—	—
Plug element	—	81 520 601	—
In-line non-return	—	—	81 529 901

## Symbol

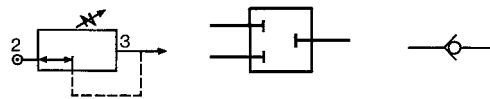

## Characteristics

Operating pressure	bars	2 → 8	—	2 → 8
Flow at 6 bars	NI/min	200	—	200
Adjustable output pressure	bar	0,1 → 8	—	—
Connection	Sub-base	•	•	—
	Push-in connection for semi-rigid tubing (NFE 49100)	mm	—	Ø 4
Weight	g	150	70	70

## Dimensions

81 529 901

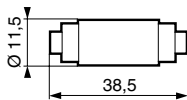

81 520 601

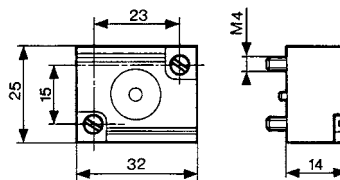

ATEX version products are available in the following catalogues: **Pneumatic products for explosive atmospheres** or on our website [www.crouzet.com](http://www.crouzet.com)



# Sub-bases for logic elements



Also available in **ATEX** version for use in potentially explosive atmospheres in accordance with 94/9/EC Directive

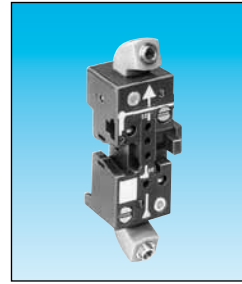
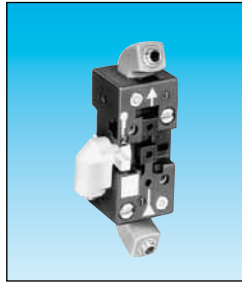

	81 532 104	81 532 102
Two-hand start module	● 1	● 1
Manostats - vacuostats	● 1	● 1
Leak sensor and amplifier relays	● 1	● 1
Logic elements AND Timers	● 1	● 1
Regulator accessories	● 1	● 1
Memory element	—	—
Operating temperature °C	-5 → +50	-5 → +50
Electro-pneumatic miniature solenoid	● 1	● 1

**NB:** The number indicates the number of components mounted on the sub-base

## Characteristics

Push-in connection for semi-rigid tubing Ø 4 mm (NFE 49100)	rotatable	rotatable
Fixation	DIN rail 35 mm	DIN rail 35 mm
Weight	g 56	52

## Connections elements and relays

### Front connecting

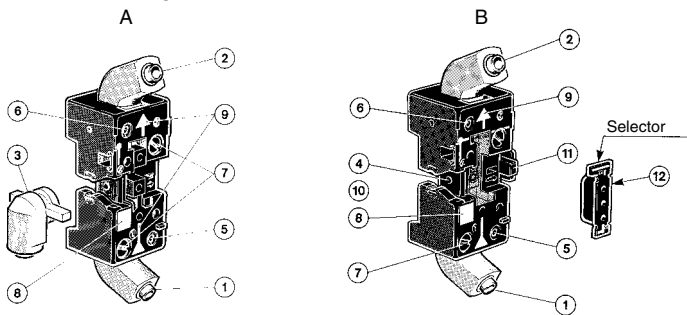

- A - Single sub-base or end base
- B - Associable sub-base
- 1 - Input port (green port 1)
- 2 - Output port (red port 3)
- 3 - Input/supply port (yellow port 2) Ø 4
- 4 - Input port integral to sub-base
- 5 - Input indicator (green)
- 6 - Output indicator (red)
- 7 - 1/4 turn screws
- 8 - Marking tag
- 9 - Arrow indicating flow direction
- 10 - Mounting tongue
- 11 - Mounting groove
- 12 - Selector

## Dimensions

■ 81 532 104      □ 3 x 81532102

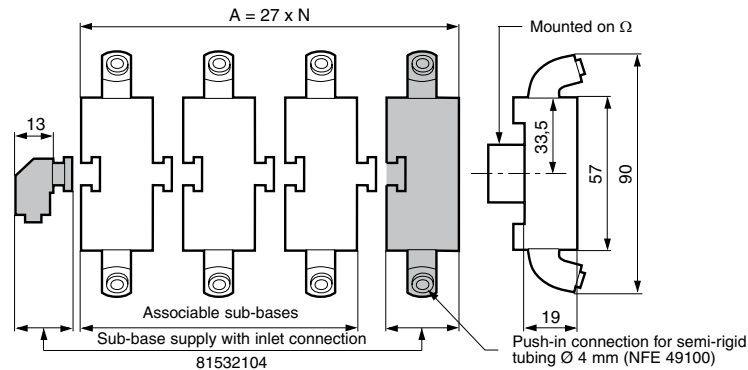

ATEX version products are available in the following catalogues: **Pneumatic products for explosive atmospheres** or on our website [www.crouzet.com](http://www.crouzet.com)

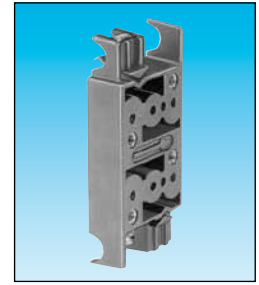
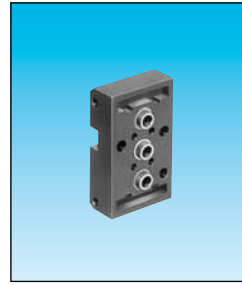
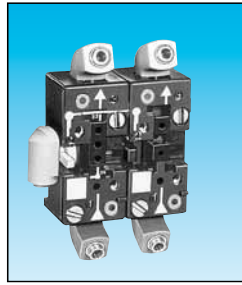

	81 542 002	81 532 001	81 531 001
Two-hand start module	—	● 1	● 2
Manostats - vacuostats	—	● 1	● 2
Leak sensor and amplifier relays	—	● 1	● 2
Logic elements AND Timers	—	● 1	● 2
Regulator accessories	—	● 1	● 2
Memory element	● 1	—	● 1
Operating temperature °C	-5 → +50	-5 → +50	-5 → +50
Electro-pneumatic miniature solenoid	—	● 1	● 2

### Caractéristiques

	rotatable	rear	rear
Push-in connection for semi-rigid tubing Ø 4 mm (NFE 49100)			
Fixation	DIN rail 35 mm	2 M4 screws	Clips for rails Ø 8 mm
Weight g	95	10	35

### Memory element sub-base, front and rear connecting

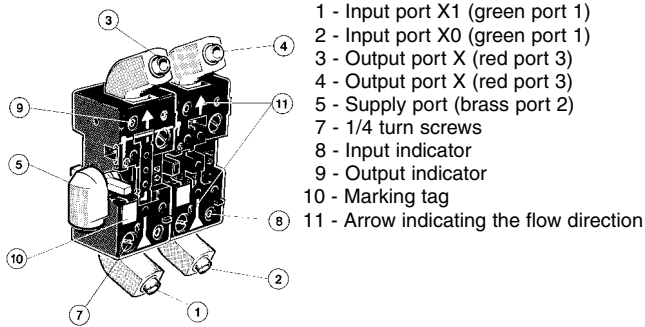

### Rear connection

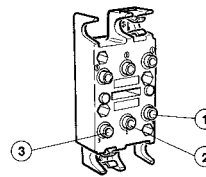

The modular system elements are fixed with two screws on the sub-base.

A locating device on each logic element prevents incorrect assembly.

The logic element is connected via the sub-base. This sub-base has 3 instant connections for connecting semi-rigid tubes with outer Ø 4.

- 1 - Input signal
- 2 - Signal port for passive logic elements, air supply for active logic elements.
- 3 - Output signal

81 542 002 (for memory 81523201/601)

81 531 001

81 532 001

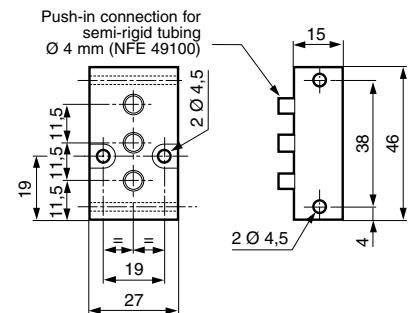
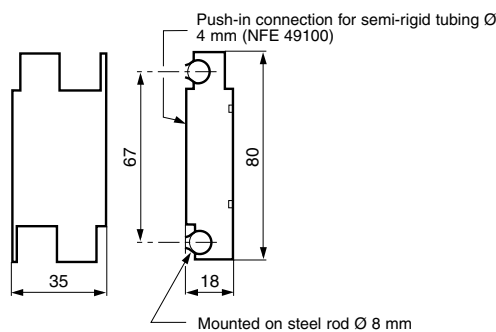
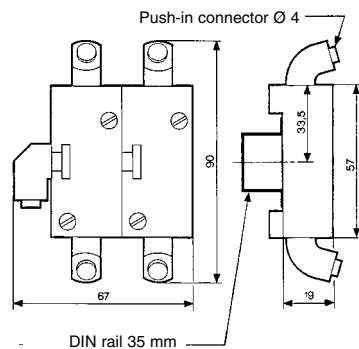

ATEX version products are available in the following catalogues: **Pneumatic products for explosive atmospheres** or on our website [www.crouzet.com](http://www.crouzet.com)

# Mounting accessories



Also available in **ATEX** version for use in potentially explosive atmospheres in accordance with 94/9/EC Directive

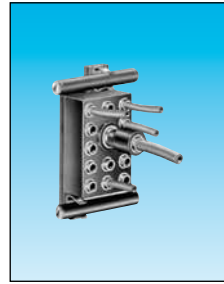
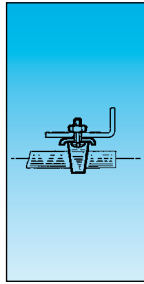
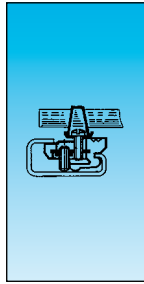
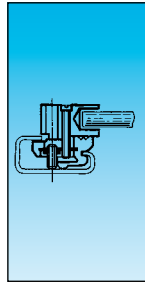

Mounting equipment

81 533 501  
Hole domino

81 533 001  
Clip domino

79 450 609  
Bar clips  
Ø 8

—

Supply manifold 13 outputs

—

—

—

81 536 801

## Characteristics

Weight (g)	8 For mounting on the end of a zinc-coated mild steel rod Ø 8 mm on an asymmetrical DIN rail	4 For adjustable mounting on a zinc-coated mild steel rod Ø 8 mm on an asymmetrical DIN rail	80 Packet of 100 pieces	80
Operating temperature °C	-5 → +50	-5 → +50	-5 → +50	-5 → +50

## Dimensions

81 536 804

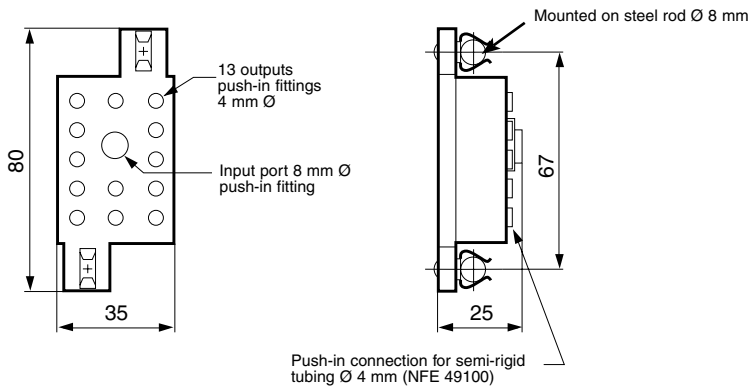

## Other information

Use Weidmuller plastic labels for marking components part number FW 4734-6.

**ATEX** version products are available in the following catalogues: **Pneumatic products for explosive atmospheres** or on our website [www.crouzet.com](http://www.crouzet.com)