

CTD 24 CTD 24 Part number 89422712



- Concentrated technology and power, using the minimum of space.
- The Smart function ensures precision auto-tuning of the CTD24

Part numbers

	Type	Output 1	Output 2	Supply
89 422 712	CTD 24	-	-	24 AC-DC

Specifications

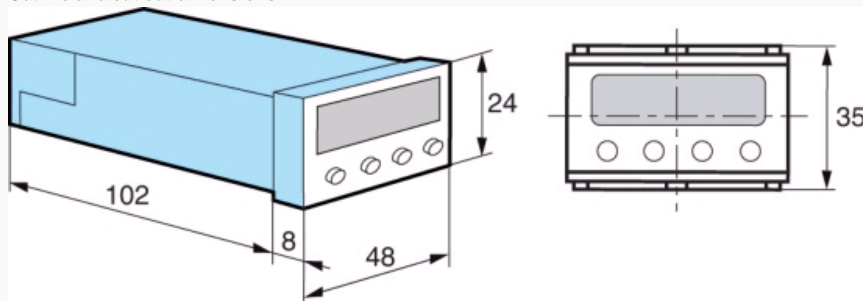
Display	4 digits
Universal input (configurable) Thermocouples	J (-100,0/999,9 °C) (-150/1830 °F) K (-100/1370 °C) (-150/2500 °F) R (-50/1760 °C) (-60/3200 °F) S (-50/1760 °C) (-60/3200 °F) T (-199,9/400 °C) (-330/750 °F) L (-100,0/900,0 °C) (-150/1650 °F) N (-100/1400 °C) (-150/2550 °F)
Universal input (configurable) Pt 100	2 and 3-wire (-199,9/850,0 °C) (-330/1560 °F)
Universal input (configurable) Linear	0-60 mV, 12-60 mV
Dimensions	24 x 48 x 102 mm
Control	PID algorithm Auto-tune using SMART function Inverse and/or direct action Soft start function for preheating
Alarms	Configurable Control loop monitoring
2 Reference points	Selected with the ramp function between them
Connection	Removable screw terminal block
Weight (g)	90
Degree of protection of front panel	IP 65 - Nema 4X

Dimensions (mm)
Outline and cut out dimensions

Dimensions (mm)

