

NNR SERIES

LIQUID LEVEL CONTROL

PUMP UP OR DOWN

SWITCH SELECTABLE

UL listed CSA recognized

- 10 Amp SPDT Rated
- Sensitivity Adjustment 4.7 kΩ to 47 kΩ
- One, Two or Three Probe Operation
- 24 VAC to 220 VAC Voltages

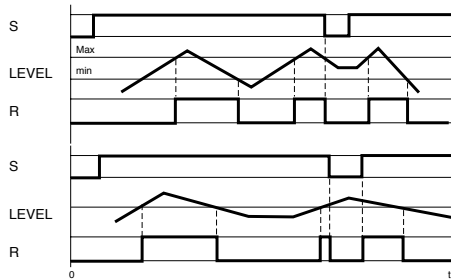
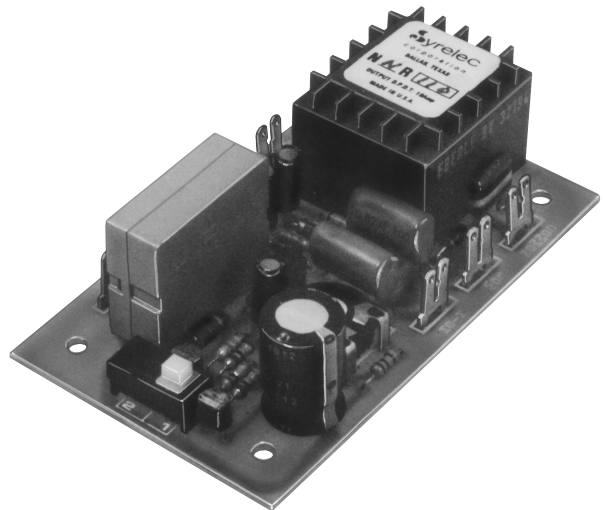

A - Pump down function: the output relay energizes when the liquid level reaches the high or max. probe. It remains energized until the level is below the low or min probe. The relay will remain de-energized until the high level is again reached. This control may also be used with only two probes by connecting the maximum and common terminals together. The output is energized when the low probe is in contact with the liquid.

B - Pump up function: when power is supplied to the unit, the output relay is energized. When the level reaches the high probe the relay is de-energized. The relay is energized again when the level falls below the low probe. The control may also be used with only two probes by connecting the maximum and common terminals together. The output is de-energized when the level reaches the low probe.

In both functions, If the container is conductive, It may be used as the common probe in some applications

SPECIFICATIONS:

Input	24, 48, 110, 220 VAC
	±15% (50/60 Hz)
Maximum power consumption	24 VAC: 1.5 VA
	48 VAC: 1.7 VA
	110 VAC: 2 VA
	220 VAC: 2 VA
Output	SPDT relay
Contact material	AgCdO (90/10)
Maximum loading	10 A AC resistive 1A DC inductive
Maximum switching voltage	250 VAC 30 VDC
Relay maximum power rating	2500 VA 30 VDC
Mechanical life of relay	3 x 10 ⁷ operations
Electrical life of relay	2 x 10 ⁶ at 2200 VA resistive load
Probe isolation	Switching contact: 2000 VA
	Electrodes: 2000 VAC
Probe sensitivity	4.7 K ohm to 47 K ohm
Probe voltage	24 VAC, 60 Hz
Probe current	2 mA max.
Operating temperature	+14°F to 140°F -10°C to +60°C
Weight	4.6 oz. (130g)

Note: For best results use shielded cable with the probes and do not run probe cables with other wires.

WIRING DIAGRAM:

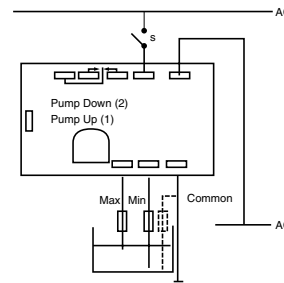

DIMENSIONS:

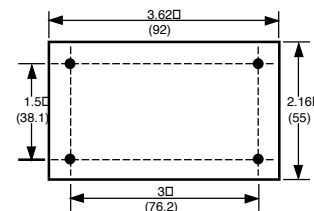

ORDERING INFORMATION:

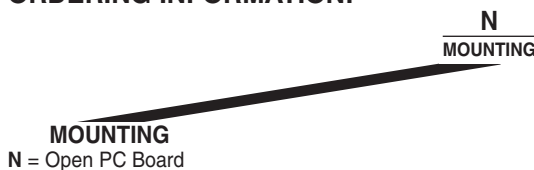

- INPUT POWER**
- 24A = 24 VAC
 - 48A = 48 VAC
 - 110A = 110 VAC
 - 220A = 220 VAC

Products and specifications subject to change without notice.

Order/Technical Support – Tel: (800) 677-5311 / FAX: (800) 677-3865 / www.crouzet-usa.com

NRU SERIES

LIQUID LEVEL CONTROL PUMP UP

UL listed CSA recognized

- LED Relay Indicator
- Three Styles
- Pump Up Control
- 4.7 kΩ to 100 kΩ Sensitivity
- 10 Amp SPDT Relay

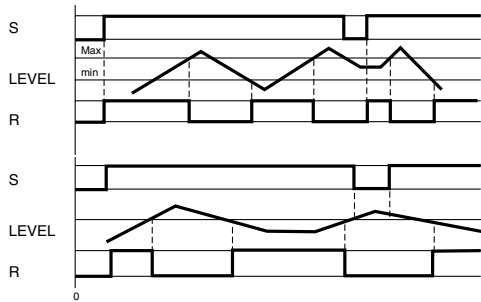
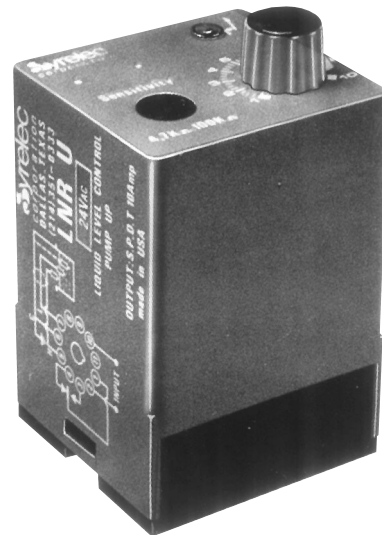

Control of conductive liquids (tap water, sea water, sewage, chemical solutions, coffee, ice cream, etc.)

The relay is energized when the level falls below the low level probe. It de-energizes when the high level probe is reached. The NRU will also control a single level. In this case, a single probe is used and the relay operates when the probe is not immersed. The Max terminal is connected to common with a jumper.

In either case, a common electrode is needed if the container is non-conductive.

SPECIFICATIONS:

Input Power	.24, 48, 110, 220 VAC, ±15% (50/60 Hz)	
Maximum voltage	.24 VAC: 1.5 VA	
	48 VAC: 1.7 VA	
	110 VAC: 2 VA	
	220 VAC: 2 VA	
Output	SPDT Relay	
Contact material	AgCdO	
Maximum loading	.10A AC resistive	8A DC resistive
Maximum switching voltage	.250 VAC	80 VDC
Maximum power rating	.2500 VA	80 W
Electrical life	.2 x 10 ⁶ at 2200 VA resistive load	
Mechanical life	.3 x 10 ⁷ operations	
Probe isolation	Electrodes: 2000 VAC	
Probe sensitivity	.4.7 K to 100 K ohms	
Probe voltage	.24 VAC, 60 Hz	
Probe current	.2 mA max.	
Operating temperature	+14°F to +140°F	-10°C to +60°C
Weight	.7 oz. (200g)	

WIRING DIAGRAM:

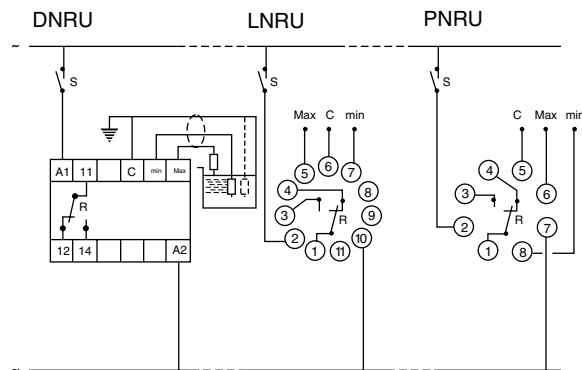

Note: The cable for probes (max 300ft) should be run in separate conduit. A shielded cable is recommended.

ORDERING INFORMATION:



Products and specifications subject to change without notice.

Order/Technical Support – Tel: (800) 677-5311 / FAX: (800) 677-3865 / www.crouzet-usa.com

NR SERIES

LIQUID LEVEL CONTROL

PUMP DOWN

UL listed CSA recognized

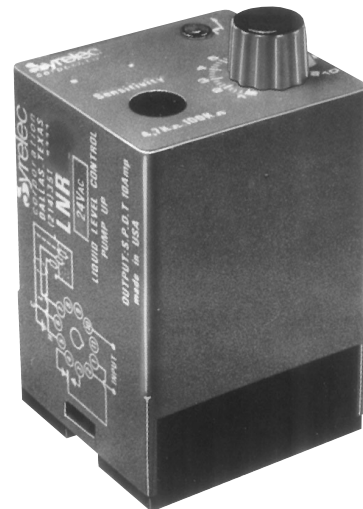

- **24 VAC to 220 VAC Operating Voltages**
- **4.7 kΩ to 100 kΩ Sensitivity**
- **LED Relay Indicator**
- **10 Amp SPDT Relay**

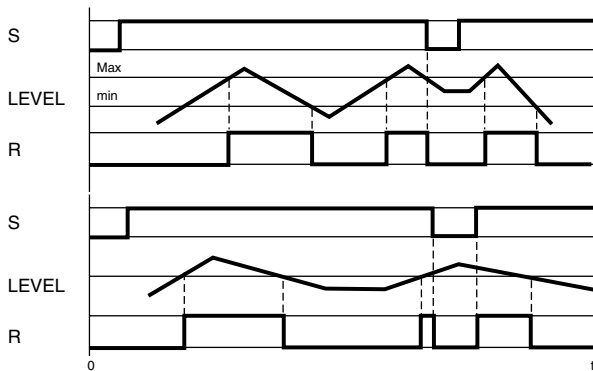

The output relay energizes when the liquid level reaches the high probe. The relay de-energizes when the liquid falls below the low probe. This control can also be used with only two probes by connecting the maximum and common terminals together. The output is energized when the level reaches the low probe. In both functions, if the container is conductive, it may be used as the common probe in some applications.

SPECIFICATIONS:

Input	24, 48, 110, 220 VAC ±15% (50/60 Hz)
Maximum power consumption	24 VAC: 1.5 VA 48 VAC: 1.7 VA 110 VAC: 2 VA 220 VAC: 2 VA
Output	SPDT relay
Contact material	AgCdO
Maximum loading	10A AC resistive 8A DC inductive
Maximum switching voltage	250 VAC 250 VDC
Relay maximum power rating	2500 VA 80 W
Mechanical life of relay	3 x 10 ⁷ operations
Electrical life of relay	2 x 10 ⁶ at 2200 VA resistive load
Probe isolation	Electrodes: 2000 VAC
Probe sensitivity	4.7 K to 100 K ohms
Probe voltage	24 VAC, 60 Hz
Probe current	2 mA max.
Operating temperature	+14°F to 140°F -10°C to +60°C
Weight	4.6 oz. (130g)

WIRING DIAGRAM:

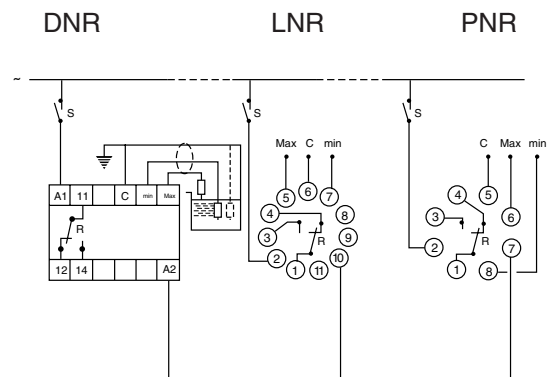

ORDERING INFORMATION:

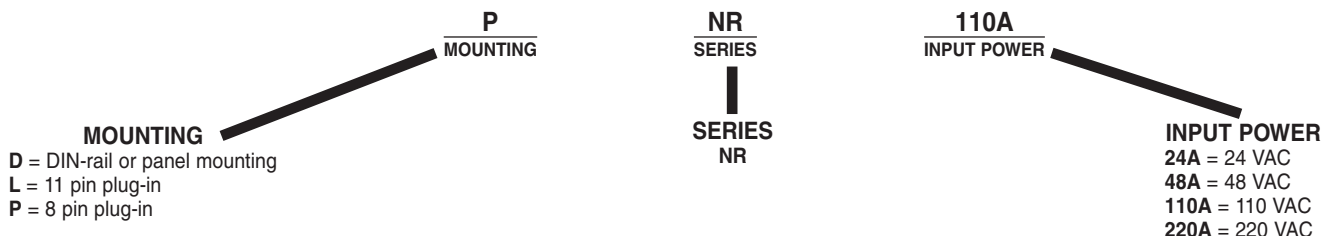

Products and specifications subject to change without notice.

Order/Technical Support – Tel: (800) 677-5311 / FAX: (800) 677-3865 / www.crouzet-usa.com

NRT SERIES

LIQUID LEVEL CONTROL CONSTANT LEVEL PUMP UP

UL listed CSA recognized

- **100 kΩ Sensitivity**
- **10 Amp SPDT Relay**
- **Maintain Constant Level**
- **Four Mounting Options**

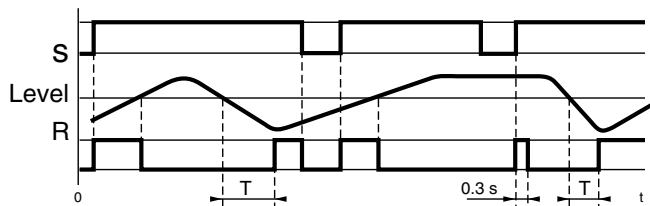
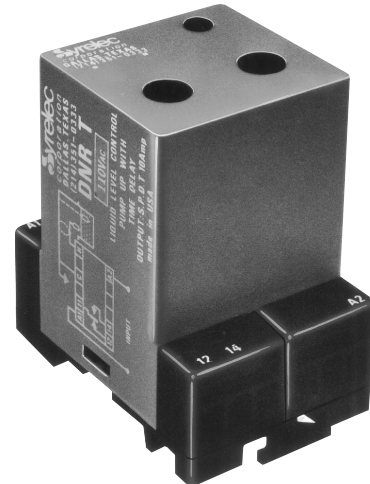

The NRT series is applied for maintaining a constant level of conductive liquid. When the liquid decreases below the probe, the relay is energized after a 4 second time delay to avoid wave disturbances. The relay de-energizes when the liquid reaches the probe. A common electrode is needed if the container is non-conductive.

SPECIFICATIONS:

Input	24 VAC, 48 VAC, 110 VAC 220 VAC, ± 15%, 50/60 Hz
Maximum power consumption ...	24 VAC: 1.5 VA 48 VAC: 1.7 VA 110 VAC: 2 VA 220 VAC: 2 VA
Output	SPDT Relay
Contact material	AgCdO
Maximum loading	10 A AC resistive 8 A Dc resistive
Maximum switching voltage	250 VAC 250 VDC
Relay maximum power rating	2500 VA 80 W
Mechanical life of relay	3 x 10 ⁷ operations
Electrical life of relay	2 x 10 ⁵ at 2200 VA resistive load
Probe isolation	Switching contact 2000 VAC Electrodes: 2000 VAC
Probe sensitivity	100 kΩ
Probe voltage	24 VAC, 60 Hz
Probe current	1 mA max.
Operating temperature	+14°F to +140°F -10°C to +60°C
Weight	7 oz. (200g)

WIRING DIAGRAM:

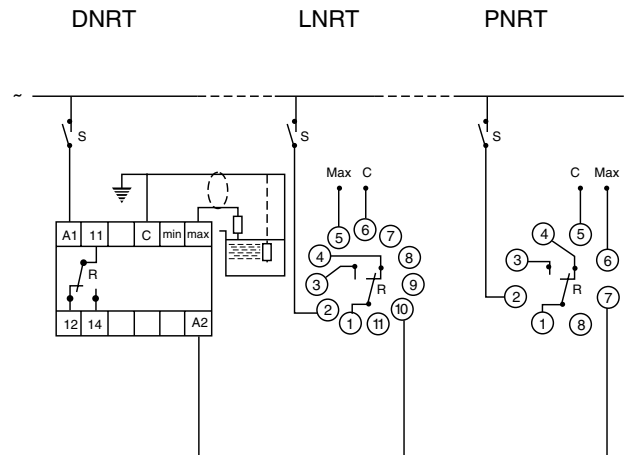

Note: The probe cables (max. 300ft) need not be shielded; however, it is not advisable to run the probe cables with power cables. If shielded cable is used, the shield and common should be connected.

ORDERING INFORMATION:

P MOUNTING	NRT SERIES	110A INPUT POWER
MOUNTING	SERIES	INPUT POWER
D = DIN-rail or panel mounting L = 11 pin plug-in P = 8 pin plug-in N = open PC board	NRT = Enclosed NNRT = Open PC board version mounting dimensions same as NNR	24A = 24 VAC 48A = 48 VAC 110A = 110 VAC 220A = 220 VAC

Products and specifications subject to change without notice.

Order/Technical Support – Tel: (800) 677-5311 / FAX: (800) 677-3865 / www.crouzet-usa.com