

## 3RHP Series DC Control

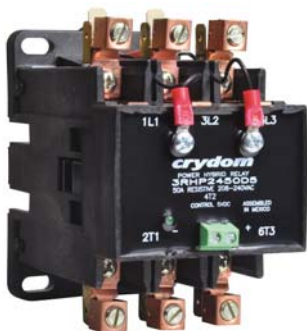

- 100K-cycle UL508 Endurance Rating for Enhanced Reliability
- 40 and 50A output
- Voltage ratings to 240 VAC
- Lifetime 2 million operations at full load
- LED input status indicator
- Wire, lug or quick connect termination
- Industry Standard DP contactor mounting

### PRODUCT SELECTION (by control voltage and output rating)

Control Voltage	40A 120 VAC	50A 120 VAC	40A 240 VAC	50A 240 VAC
4.5-5.5 VDC	3RHP1240D5	3RHP1250D5	3RHP2440D5	3RHP2450D5
10-15 VDC	3RHP1240D12	3RHP1250D12	3RHP2440D12	3RHP2450D12
22-27 VDC	3RHP1240D24	3RHP1250D24	3RHP2440D24	3RHP2450D24

### OUTPUT SPECIFICATIONS (voltage)

Description	120 VAC	240 VAC
Operating Voltage (47-63Hz) [Vrms]	100-120	208-240
Maximum Off-State Leakage Current per channel	0.05 mA @ 120 VAC	0.06 mA @ 240 VAC

### OUTPUT SPECIFICATIONS (current)

Description	40A	50A
Maximum Load Current per phase @ 40°C [Arms] (1)	40A Resistive	50A Resistive
Power terminals	1/4" Quick Connect and 10x32 binder head screws	1/4" Quick Connect and box lugs
Wire Size	8-14 AWG	6-14 AWG

### INPUT SPECIFICATIONS

Description	SUFIX D5	SUFIX D12	SUFIX D24
Coil Voltage	4.5-5.5 VDC	10-15 VDC	22-27 VDC
Max. Reverse Voltage	-5.5 VDC	-15.5 VDC	-27.5 VDC
Input Current	12mA @ 5 VDC	12mA @ 12 VDC	12mA @ 24 VDC
Min. Turn-On Voltage	4.5 VDC	9.5 VDC	9.5 VDC
Min. Turn-Off Voltage	1 VDC	2 VDC	2 VDC

### GENERAL SPECIFICATIONS

Description	Parameters
Dielectric Strength, Input to Output	4000 Vrms
Dielectric Strength, Input/Output to ground	2500 Vrms
Contacts (2)	Three Normally Open
Ambient Operating Temperature Range (3)	-20 to 75 °C
Ambient Storage Temperature Range	-40 to 100 °C
Max. Turn-On Time 50/60 Hz	20 ms / 16.6 ms
Max. Turn-Off Time 50/60Hz	40 ms / 32 ms
Maximum Number of Operations	30 per Minute
Lifetime Number of Operations @ Rated Current (4)	> 2 Million
Weight (typical)	1.19 lbs (540 g)
Screw Torque (input/output) 40A	4.4-5 in lb (0.5-0.6 Nm) / 15-18 in lb (1.7-2.1 Nm)
Screw Torque (input/output) 50A	4.4-5 in lb (0.5-0.6 Nm) / 20-25 in lb (2.2-2.9 Nm)

**GENERAL NOTES**

- (1) See Derating curves for additional operating conditions.
- (2) The RHP includes a Solid State Relay, therefore electrical isolation is not provided.
- (3) The RHP includes over temperature protection for the solid state relay.
- (4) 40°C ambient temperature, 30 operations/min, maximum voltage control.

**MECHANICAL SPECIFICATIONS**

(Tolerances: ± 0.02 in / 0.5 mm)

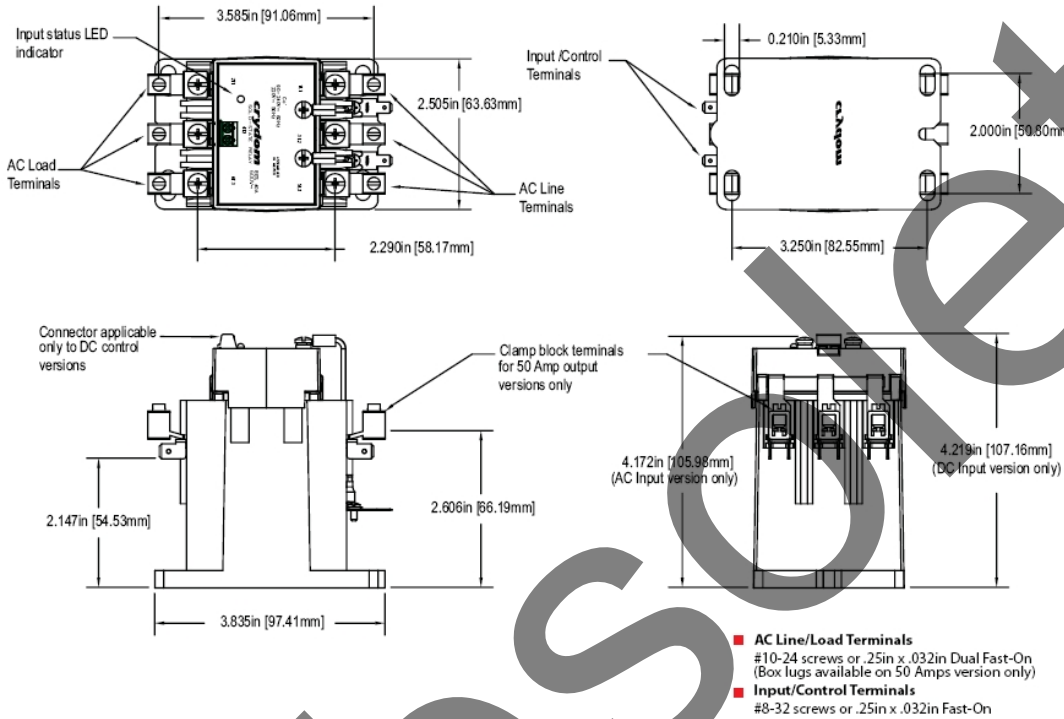

**THERMAL DERATE INFORMATION**

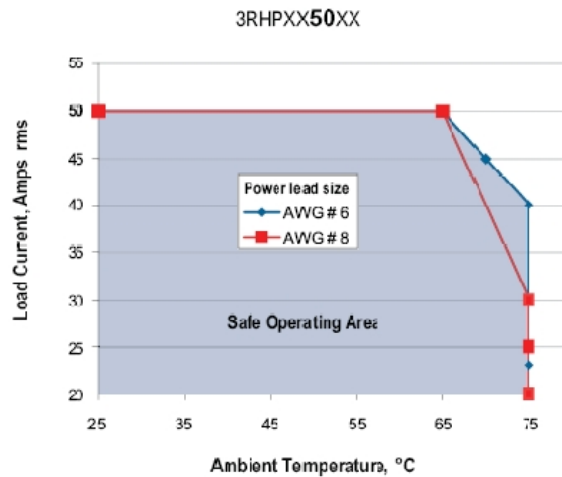
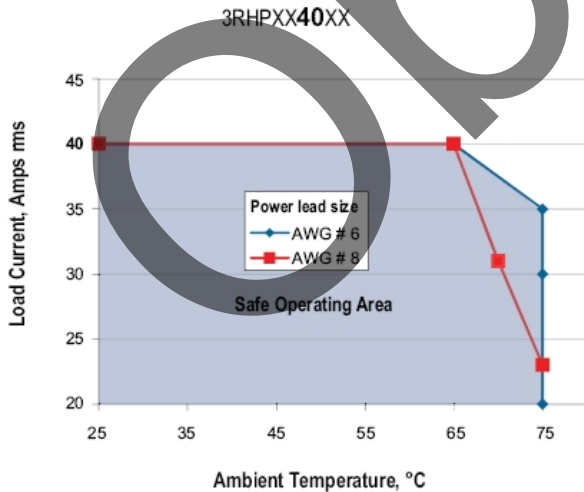

## TYPICAL ELECTRICAL CONNECTIONS

### Typical Electrical Connection for 3 Phase Applications<sup>Ⓞ</sup>

(For output voltage options 24, 28, 60)

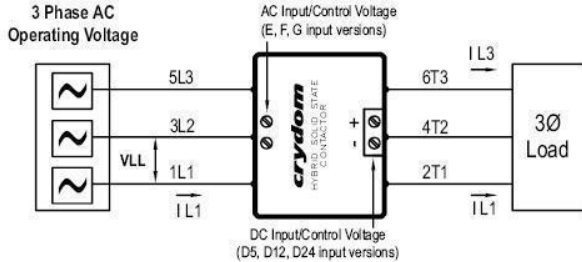

DO NOT apply any AC voltage to DC contactor coil connections

### Optional Electrical Connections for Single Phase Applications<sup>Ⓞ</sup>

(For output voltage options 12, 24, 28, 60)

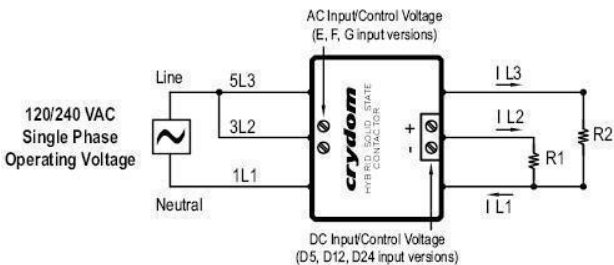

DO NOT apply any AC voltage to DC contactor coil connections

$$IL1 = (IL2 + IL3) \leq \text{Rated current}$$

- Ⓞ Match VLL to voltage suffixes 28 & 60 for options E, F & G and 12 & 24 for options DX.
- Ⓞ The single phase supply voltage must be wired to terminal 1L1 and 3L2 for proper single phase operation.
- Ⓞ In applications switching two single phase loads (R1 and R2) where the combined load current exceeds the contactor's rating (40 or 50 Amps) the return/neutral lead must not be wired through the contactor (see above drawing).

Caution: Risk of overheating. Do not allow any single phase connection to exceed the current rating of the relay. Failure to follow these instructions may result in equipment damage.

### Optional Electrical Connections for Single Phase Applications<sup>Ⓞ</sup>

(For output voltage options 12, 24, 28, 60)

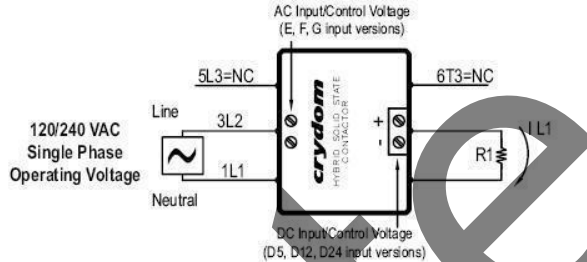

DO NOT apply any AC voltage to DC contactor coil connections

$$IL1 \leq \text{Rated current}$$

### Optional Electrical Connections for Single Phase Applications<sup>Ⓞ</sup>

(For output voltage options 12, 24, 28, 60)

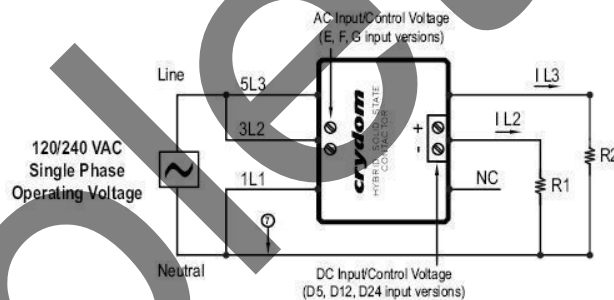

DO NOT apply any AC voltage to DC contactor coil connections

$$IL2 \leq \text{Rated current}$$

$$IL3 \leq \text{Rated current}$$

$$IL2 + IL3 > \text{Rated current}$$

## AGENCY APPROVALS

UL/cUL UL508, E116950

CE EN60950-1-2006

Rev.073011

**ACCESSORIES**

**Accessories**



**DIN rail bracket**

Part Number DMB3

Description DIN Rail mounting adaptor kit



**Auxiliary contact**

HAC1

Includes one normally open & one normally closed contact, each rated @ 5 Amps rms, 600 VAC, 50/60 Hz 2.5 in Quick Connect



**Mounted auxiliary contact**

Note: 3RHP accommodates one or two HAC1 auxiliary contacts



**Mounted DIN rail bracket**

Obsole



 <b>DANGER / PELIGRO / DANGER /GEFAHR / PERICOLO / PERIGO</b>					
<p><b>HAZARD OF ELECTRIC SHOCK, EXPLOSION, OR ARC FLASH.</b></p> <ul style="list-style-type: none"> <li>• Disconnect all power before installing or working with this equipment.</li> <li>• Verify all connections and replace all covers before turning on power.</li> </ul> <p><b>Failure to follow these instructions will result in death or serious injury.</b></p>	<p><b>RIESGO DE DESCARGA ELECTRICA O EXPLOSION.</b></p> <ul style="list-style-type: none"> <li>• Desconectar todos los suministros de energia a este equipo antes de trabajar con este equipo.</li> <li>• Verificar todas las conexiones y colocar todas las tapas antes de energizar el equipo.</li> </ul> <p><b>El incumplimiento de estas instrucciones puede provocar la muerte o lesiones serias.</b></p>	<p><b>RISQUE DE DESCARGE ELECTRIQUE OU EXPLOSION</b></p> <ul style="list-style-type: none"> <li>• Eteindre toutes les sources d'énergie de cet appareil avant de travailler dessus de cet appareil</li> <li>• Vérifier tous connections, et remettre tous couverts en place avant de mettre sous</li> </ul> <p><b>De non-suivi de ces instructions provoquera la mort ou des lésions sérieuses sérieuses.</b></p>	<p><b>GEFAHR EINES ELEKTRISCHE N SCHLAGES ODER EINER EXPLOSION.</b></p> <ul style="list-style-type: none"> <li>• Stellen Sie jeglichen Strom ab, der dieses Gerät versorgt, bevor Sie an dem Gerät Arbeiten durchführen</li> <li>• Vor der Inbetriebnahme alle Anschlüsse überprüfen und alle Gehäuseteile montieren.</li> </ul> <p><b>Unterlassung dieser Anweisungen können zum Tode oder zu schweren Verletzungen führen.</b></p>	<p><b>RISCHIO DI SCOSSA ELETTRICA O DELL'ESPLOSIONE.</b></p> <ul style="list-style-type: none"> <li>• Spenga tutta l'alimentazione e che fornisce questa apparecchiatura prima del lavorare a questa apparecchiatura</li> <li>• Verificare tutti i collegamenti e sostituire tutte le coperture prima della rotazione sull'alimentazione</li> </ul> <p><b>L'omissione di seguire queste istruzioni provocherà la morte o di lesioni serie</b></p>	<p><b>RISCO DE DESCARGA ELÉTRICA OU EXPLOÇÃO</b></p> <ul style="list-style-type: none"> <li>• Desconectar o equipamento de toda a energia antes de instalar ou trabalhar com este equipamento</li> <li>• Verificar todas as conexões e recolocar todas as tampas antes de religar o equipamento</li> </ul> <p><b>O não cumprimento destas instruções pode levar à morte ou lesões sérias.</b></p>

 <b>WARNING / AVERTISSEMENT / WARNUNG /ADVERTENCIA / AVVERTENZA / AVISO</b>		
<p><b>RISK OF MATERIAL DAMAGE AND HOT ENCLOSURE</b></p> <ul style="list-style-type: none"> <li>• The product's side panels may be hot, allow the product to cool before touching.</li> <li>• Follow proper mounting instructions including torque values.</li> <li>• Do not allow liquids or foreign objects to enter this product.</li> </ul> <p><b>Failure to follow these instructions can result in serious injury, or equipment damage.</b></p>	<p><b>RISQUE DE DOMMAGE MATERIEL ET DE SURCHAUFFE DU BOITIER</b></p> <ul style="list-style-type: none"> <li>• Les panneaux latéraux du produit peuvent être chauds. Laissez le produit refroidir avant de le toucher.</li> <li>• Respecter les consignes de montage, et notamment les couples de serrage.</li> <li>• Ne pas laisser pénétrer de liquide ni de corps étrangers à l'intérieur du produit.</li> </ul> <p><b>Le non-respect de cette directive peut entraîner, des lésions corporelles graves ou des dommages matériels.</b></p>	<p><b>GEFAHR VON MATERIALSCHÄDEN UND GEHÄUSEERHITZUNG</b></p> <ul style="list-style-type: none"> <li>• Die Seitenwände können heiß sein. Lassen Sie das Produkt abkühlen, bevor Sie es berühren.</li> <li>• Beachten Sie die Montageanweisungen,</li> <li>• Führen Sie keine Flüssigkeiten oder Fremdkörper in das Produkt ein.</li> </ul> <p><b>Die Nichtbeachtung dieser Anweisung kann Körperverletzung oder Materialschäden zur Folge haben.</b></p>
<p><b>RIESGO DE DAÑOS MATERIALES Y DE SOBRECIENTAMIENTO DE LA UNIDAD</b></p> <ul style="list-style-type: none"> <li>• Los paneles laterales del producto pueden estar calientes. Esperar que el producto se enfríe antes de tocarlo.</li> <li>• Respetar las instrucciones de montaje, y en particular los pares de apretado.</li> <li>• No dejar que penetren líquidos o cuerpos extraños en el producto.</li> </ul> <p><b>Si no se respetan estas precauciones pueden producirse graves lesiones, daños materiales.</b></p>	<p><b>RISCHIO DI DANNI MATERIALI E D'INVOLUCRO CALDO</b></p> <ul style="list-style-type: none"> <li>• I pannelli laterali dell'apparecchio possono scottare; lasciar quindi raffreddare il prodotto prima di toccarlo.</li> <li>• Seguire le istruzioni di montaggio corrette.</li> <li>• Non far entrare liquidi o oggetti estranei in questo apparecchio.</li> </ul> <p><b>La mancata osservanza di questa precauzione può causare gravi rischi per l'incolumità personale o danni alle apparecchiature.</b></p>	<p><b>RISCO DE DANO MATERIAL E DE AQUECIMENTO</b></p> <ul style="list-style-type: none"> <li>• Os painéis laterais do produto podem estar quentes; dê tempo ao produto para arrefecer antes de lhe tocar.</li> <li>• Siga devidamente as instruções de montagem.</li> <li>• Não permita a entrada de líquidos e de objectos estranhos no produto.</li> </ul> <p><b>A não observância destas precauções pode provocar a morte, ferimentos graves ou danos materiais.</b></p>

**ANNEX - ENVIROMENTAL INFORMATION**

The environmental information disclosed in this annex including the EIP Pollution logo are in compliance with People's Republic of China Electronic Industry Standard SJ/T11364 – 2006, Marking for Control of Pollution Caused by Electronic Information Products.

Part Name	Toxic or hazardous Substance and Elements					
	Lead (Pb)	Mercury (Hg)	Cadmium (Cd)	Hexavalent Chromium (Cr (VI))	Polybrominated biphenyls (PBB)	Polybrominated diphenyl ethers (PBDE)
Semiconductor die	X	0	0	0	0	0
Solder	X	0	0	0	0	0

此附件所标示的包括电子信息产品污染图标的环保信息符合中华人民共和国电子行业标准 **SJ/T11364 - 2006**, 电子信息产品污染控制标识要求

部件名称	有毒有害物质或元素					
	铅 (Pb)	汞 (Hg)	镉 (Cd)	六价铬 (Cr (VI))	多溴联苯 (PBB)	多溴二苯醚 (PBDE)
半导体芯片	X	0	0	0	0	0
焊接点	X	0	0	0	0	0



Obsole