

4-Mbit (256 K × 16) Static RAM

Features

- Temperature ranges
 - Industrial: -40 °C to 85 °C
- Pin and function compatible with CY7C1041CV33
- High speed
 - $t_{AA} = 10 \text{ ns}$
- Low active power
 - $I_{CC} = 90 \text{ mA}$
- Low CMOS standby power
 - $I_{SB2} = 10 \text{ mA}$
- 2.0 V data retention
- Automatic power-down when deselected
- TTL compatible inputs and outputs
- Easy memory expansion with \overline{CE} and \overline{OE} features
- Available in Pb-free 48-ball VFBGA, 44-pin (400-mil) molded SOJ, and 44-pin TSOP II Packages

Functional Description

The CY7C1041DV33 is a high performance CMOS Static RAM organized as 256 K words by 16-bits. To write to the device, take chip enable (\overline{CE}) and write enable (\overline{WE}) inputs LOW. If byte low enable (BLE) is LOW, then data from I/O pins (I/O₀ to I/O₇) is written into the location specified on the address pins (A₀ to A₁₇). If byte high enable (BHE) is LOW, then data from I/O pins (I/O₈ to I/O₁₅) is written into the location specified on the address pins (A₀ to A₁₇).

To read from the device, take chip enable (\overline{CE}) and output enable (\overline{OE}) LOW while forcing the write enable (\overline{WE}) HIGH. If BLE is LOW, then data from the memory location specified by the address pins appears on I/O₀ to I/O₇. If BHE is LOW, then data from memory appears on I/O₈ to I/O₁₅. See the Truth Table on page 11 for a complete description of read and write modes.

The input and output pins (I/O₀ to I/O₁₅) are placed in a high impedance state when the device is deselected (\overline{CE} HIGH), outputs are disabled (\overline{OE} HIGH), BHE and BLE are disabled (\overline{BHE} , \overline{BLE} HIGH), or during a write operation (\overline{CE} LOW and \overline{WE} LOW).

The CY7C1041DV33 is available in a standard 44-pin 400-mil wide SOJ and 44-pin TSOP II package with center power and ground (revolutionary) pinout and a 48-ball FBGA package.

For a complete list of related documentation, [click here](#).

Logic Block Diagram

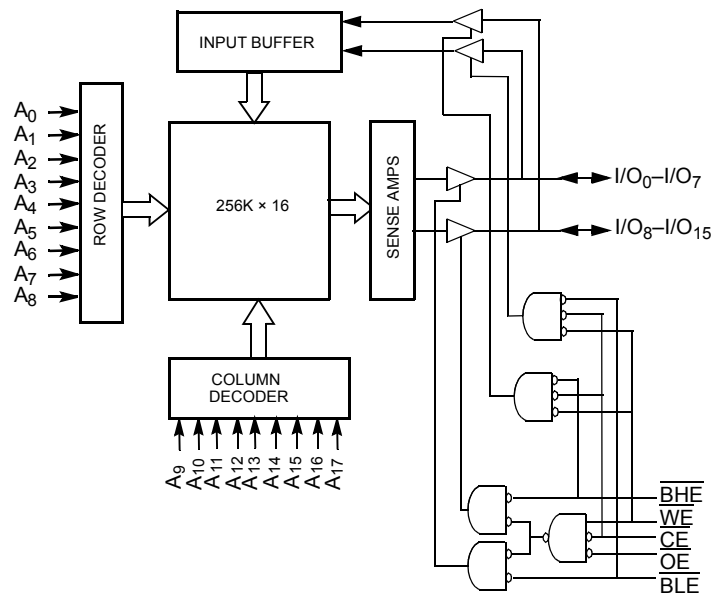

Contents

Selection Guide	3	Ordering Information	12
Pin Configuration	3	Ordering Code Definitions	12
Maximum Ratings	4	Package Diagrams	13
Operating Range	4	Acronyms	15
DC Electrical Characteristics	4	Document Conventions	15
Capacitance	5	Units of Measure	15
Thermal Resistance	5	Document History Page	16
AC Test Loads and Waveforms	5	Sales, Solutions, and Legal Information	18
Data Retention Characteristics	6	Worldwide Sales and Design Support	18
Data Retention Waveform	6	Products	18
AC Switching Characteristics	7	PSoC® Solutions	18
Switching Waveforms	8	Cypress Developer Community	18
Truth Table	11	Technical Support	18

Selection Guide

Description	-10 (Industrial)	Unit
Maximum access time	10	ns
Maximum operating current	90	mA
Maximum CMOS standby current	10	mA

Pin Configuration

Figure 1. 48-ball VFBGA (Pinout 1) [1, 2]

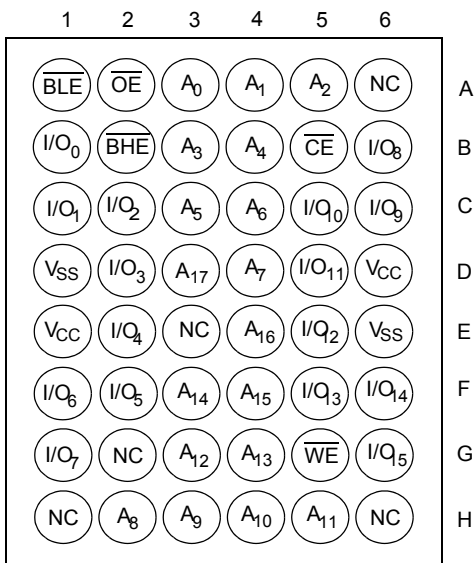

Figure 2. 48-ball VFBGA (Pinout 2) [1, 2]

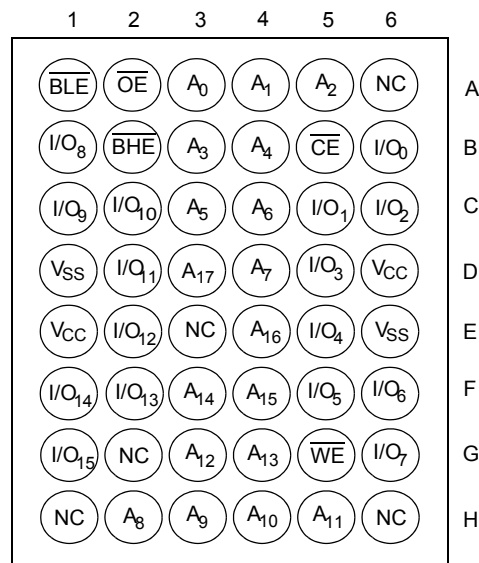
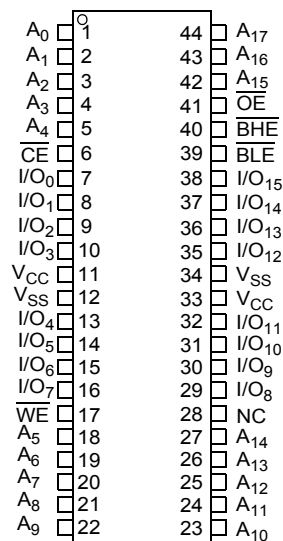

Figure 3. 44-pin SOJ/TSOP II pinout



Notes

1. NC pins are not connected on the die.
2. Pinout 1 is compliant with CY7C1041CV33 and pinout 2 is JEDEC compliant. The difference between the two is that the higher and lower byte I/Os (I/O_[7:0] and I/O_[15:8] balls) are swapped.

Maximum Ratings

Exceeding maximum ratings may impair the useful life of the device. These user guidelines are not tested.

Storage temperature -65 °C to +150 °C
 Ambient temperature with power applied -55 °C to +125 °C
 Supply voltage on V_{CC} relative to GND ^[3] ... -0.3 V to +4.6 V
 DC voltage applied to outputs in high Z State ^[3] -0.3 V to $V_{CC} + 0.3$ V

DC input voltage ^[3] -0.3 V to $V_{CC} + 0.3$ V
 Current into outputs (LOW) 20 mA
 Static discharge voltage (MIL-STD-883, method 3015) > 2001 V
 Latch up current > 200 mA

Operating Range

Range	Ambient Temperature	V_{CC}	Speed
Industrial	-40 °C to +85 °C	3.3 V ± 0.3 V	10 ns

DC Electrical Characteristics

Over the Operating Range

Parameter	Description	Test Conditions	-10 (Industrial)		Unit	
			Min	Max		
V_{OH}	Output HIGH voltage	$V_{CC} = \text{Min}, I_{OH} = -4.0 \text{ mA}$	2.4	-	V	
V_{OL}	Output LOW voltage	$V_{CC} = \text{Min}, I_{OL} = 8.0 \text{ mA}$	-	0.4	V	
$V_{IH}^{[3]}$	Input HIGH voltage		2.0	$V_{CC} + 0.3$	V	
$V_{IL}^{[3]}$	Input LOW voltage		-0.3	0.8	V	
I_{IX}	Input leakage current	$GND \leq V_I \leq V_{CC}$	-1	+1	μA	
I_{OZ}	Output leakage current	$GND \leq V_{OUT} \leq V_{CC}$, output disabled	-1	+1	μA	
I_{CC}	V_{CC} operating supply current	$V_{CC} = \text{Max}, f = f_{MAX} = 1/t_{RC}$	100 MHz	-	90	mA
			83 MHz	-	80	mA
			66 MHz	-	70	mA
			40 MHz	-	60	mA
I_{SB1}	Automatic CE power-down current – TTL inputs	Max V_{CC} , $\overline{CE} \geq V_{IH}$, $V_{IN} \geq V_{IH}$ or $V_{IN} \leq V_{IL}$, $f = f_{MAX}$	-	20	mA	
I_{SB2}	Automatic CE power-down current – CMOS inputs	Max V_{CC} , $\overline{CE} \geq V_{CC} - 0.3 \text{ V}$, $V_{IN} \geq V_{CC} - 0.3 \text{ V}$ or $V_{IN} \leq 0.3 \text{ V}$, $f = 0$	-	10	mA	

Note

3. Minimum voltage is -2.0 V and $V_{IH}(\text{max}) = V_{CC} + 2 \text{ V}$ for pulse durations of less than 20 ns.

Capacitance

Parameter ^[4]	Description	Test Conditions	Max	Unit
C _{IN}	Input capacitance	T _A = 25 °C, f = 1 MHz, V _{CC} = 3.3 V	8	pF
C _{OUT}	I/O capacitance		8	pF

Thermal Resistance

Parameter ^[4]	Description	Test Conditions	48-ball FBGA Package	44-pin SOJ Package	44-pin TSOP II Package	Unit
Θ _{JA}	Thermal resistance (junction to ambient)	Still Air, soldered on a 3 × 4.5 inch, four layer printed circuit board	27.89	57.91	50.66	°C/W
Θ _{JC}	Thermal resistance (junction to case)		14.74	36.73	17.17	°C/W

AC Test Loads and Waveforms

The AC test loads and waveform diagram follows.

Figure 4. AC Test Loads and Waveforms ^[5]

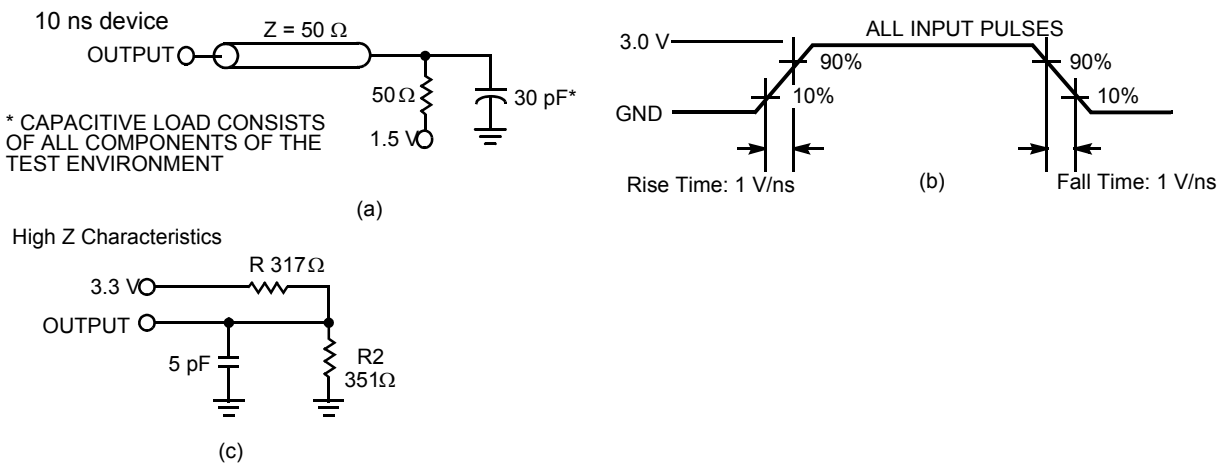

Notes

- 4. Tested initially and after any design or process changes that may affect these parameters.
- 5. AC characteristics (except high Z) are tested using the load conditions shown in Figure 4 (a). High Z characteristics are tested for all speeds using the test load shown in Figure 4 (c).

Data Retention Characteristics

Over the Operating Range

Parameter	Description	Conditions ^[6]	Min	Max	Unit
V_{DR}	V_{CC} for data retention		2.0	–	V
I_{CCDR}	Data retention current	$V_{CC} = V_{DR} = 2.0\text{ V}$, $\overline{CE} \geq V_{CC} - 0.3\text{ V}$, $V_{IN} \geq V_{CC} - 0.3\text{ V}$ or $V_{IN} \leq 0.3\text{ V}$	–	10	mA
t_{CDR} ^[7]	Chip deselect to data retention time		0	–	ns
t_R ^[8]	Operation recovery time		t_{RC}	–	ns

Data Retention Waveform

Figure 5. Data Retention Waveform

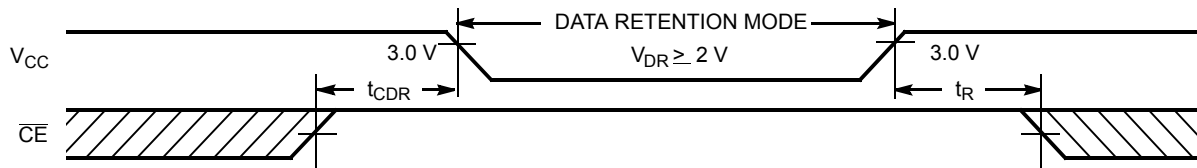

Notes

- No input may exceed $V_{CC} + 0.3\text{ V}$.
- Tested initially and after any design or process changes that may affect these parameters.
- Full device operation requires linear V_{CC} ramp from V_{DR} to $V_{CC(min.)} \geq 50\ \mu\text{s}$ or stable at $V_{CC(min.)} \geq 50\ \mu\text{s}$.

AC Switching Characteristics

Over the Operating Range

Parameter ^[9]	Description	-10 (Industrial)		Unit
		Min	Max	
Read Cycle				
$t_{power}^{[10]}$	V_{CC} (Typical) to the first access	100	–	μ s
t_{RC}	Read cycle time	10	–	ns
t_{AA}	Address to data valid	–	10	ns
t_{OHA}	Data hold from address change	3	–	ns
t_{ACE}	\overline{CE} LOW to data valid	–	10	ns
t_{DOE}	\overline{OE} LOW to data valid	–	5	ns
t_{LZOE}	\overline{OE} LOW to low Z ^[11]	0	–	ns
t_{HZOE}	\overline{OE} HIGH to high Z ^[11, 12]	–	5	ns
t_{LZCE}	\overline{CE} LOW to low Z ^[11]	3	–	ns
t_{HZCE}	\overline{CE} HIGH to high Z ^[11, 12]	–	5	ns
t_{PU}	\overline{CE} LOW to power-up	0	–	ns
t_{PD}	\overline{CE} HIGH to power-down	–	10	ns
t_{DBE}	Byte enable to data valid	–	5	ns
t_{LZBE}	Byte enable to low Z	0	–	ns
t_{HZBE}	Byte disable to high Z	–	6	ns
Write Cycle^[13, 14]				
t_{WC}	Write cycle time	10	–	ns
t_{SCE}	\overline{CE} LOW to write end	7	–	ns
t_{AW}	Address setup to write end	7	–	ns
t_{HA}	Address hold from write end	0	–	ns
t_{SA}	Address setup to write start	0	–	ns
t_{PWE}	\overline{WE} pulse width	7	–	ns
t_{SD}	Data setup to write end	5	–	ns
t_{HD}	Data hold from write end	0	–	ns
t_{LZWE}	\overline{WE} HIGH to low Z ^[11]	3	–	ns
t_{HZWE}	\overline{WE} LOW to high Z ^[11, 12]	–	5	ns
t_{BW}	Byte enable to end of write	7	–	ns

Notes

9. Test conditions assume signal transition time of 3 ns or less, timing reference levels of 1.5 V, input pulse levels of 0 to 3.0 V, and output loading of the specified I_{OL}/I_{OH} and 30-pF load capacitance.
10. t_{POWER} gives the minimum amount of time that the power supply should be at typical V_{CC} values until the first memory access is performed.
11. At any given temperature and voltage condition, t_{HZCE} is less than t_{LZCE} , t_{HZOE} is less than t_{LZOE} , t_{HZBE} is less than t_{LZBE} , and t_{HZWE} is less than t_{LZWE} for any given device.
12. t_{HZOE} , t_{HZCE} , t_{HZBE} , and t_{HZWE} are specified with a load capacitance of 5 pF as in part (c) of Figure 4. Transition is measured when the outputs enter a high impedance state.
13. The internal write time of the memory is defined by the overlap of \overline{CE} LOW and BHE or BLE, and \overline{WE} LOW. All signals must be in valid states to initiate a Write, but any one signal can go inactive to terminate the write.
14. The minimum write cycle time for Write Cycle No. 4 (\overline{WE} controlled, \overline{OE} LOW) is the sum of t_{HZWE} and t_{SD} .

Switching Waveforms

Figure 6. Read Cycle No. 1 [15, 16]

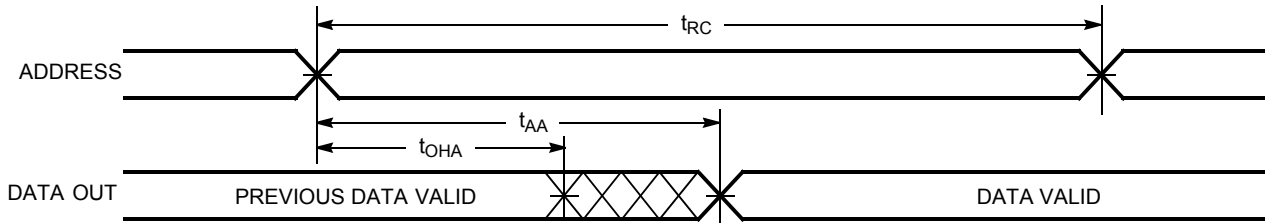
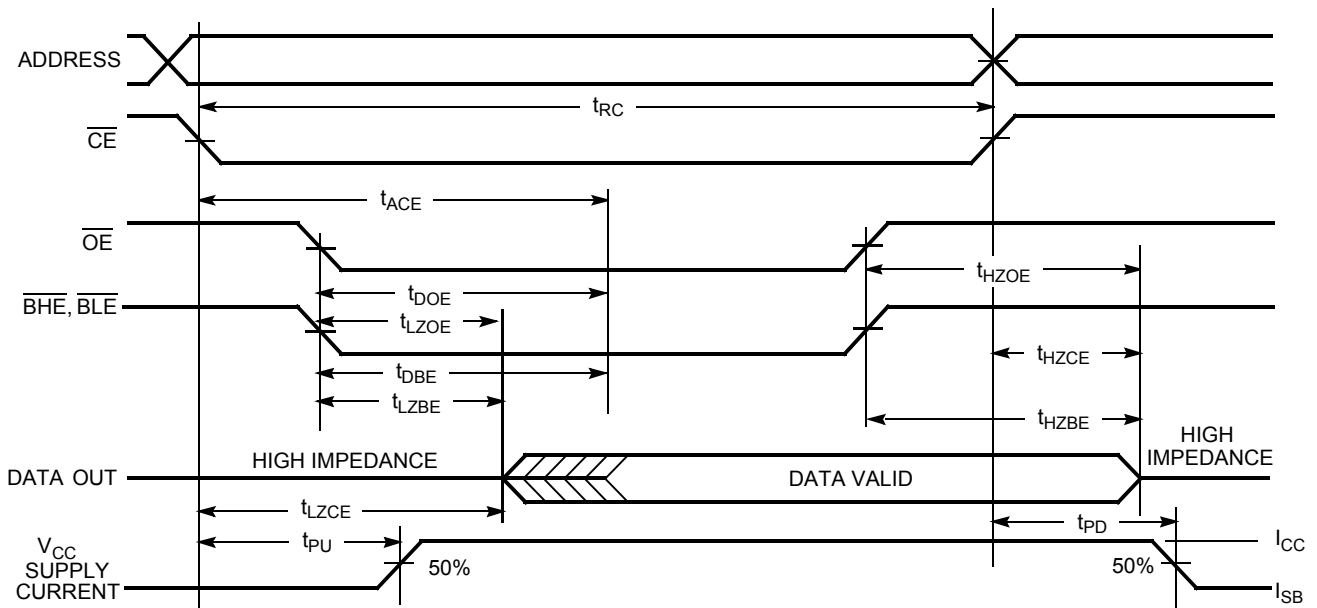

Figure 7. Read Cycle No. 2 (\overline{OE} Controlled) [16, 17]



Notes

- 15. Device is continuously selected. \overline{OE} , \overline{CE} , \overline{BHE} , and \overline{BLE} = V_{IL} .
- 16. \overline{WE} is HIGH for read cycle.
- 17. Address valid prior to or coincident with \overline{CE} transition LOW.

Switching Waveforms (continued)

Figure 8. Write Cycle No. 1 ($\overline{\text{CE}}$ Controlled) [18, 19]

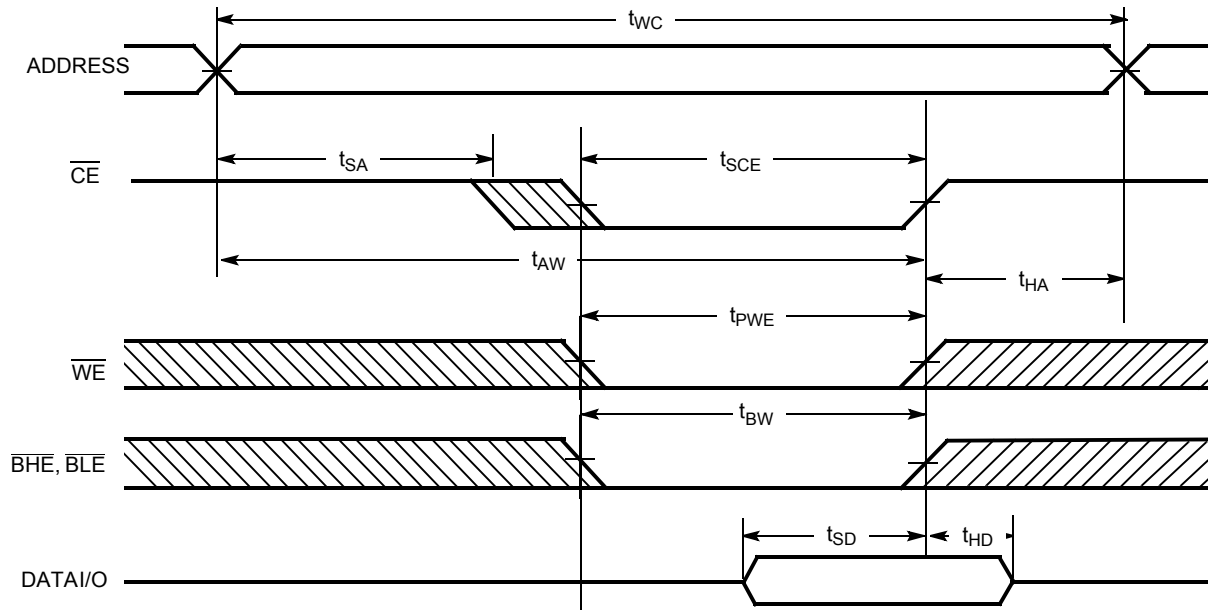
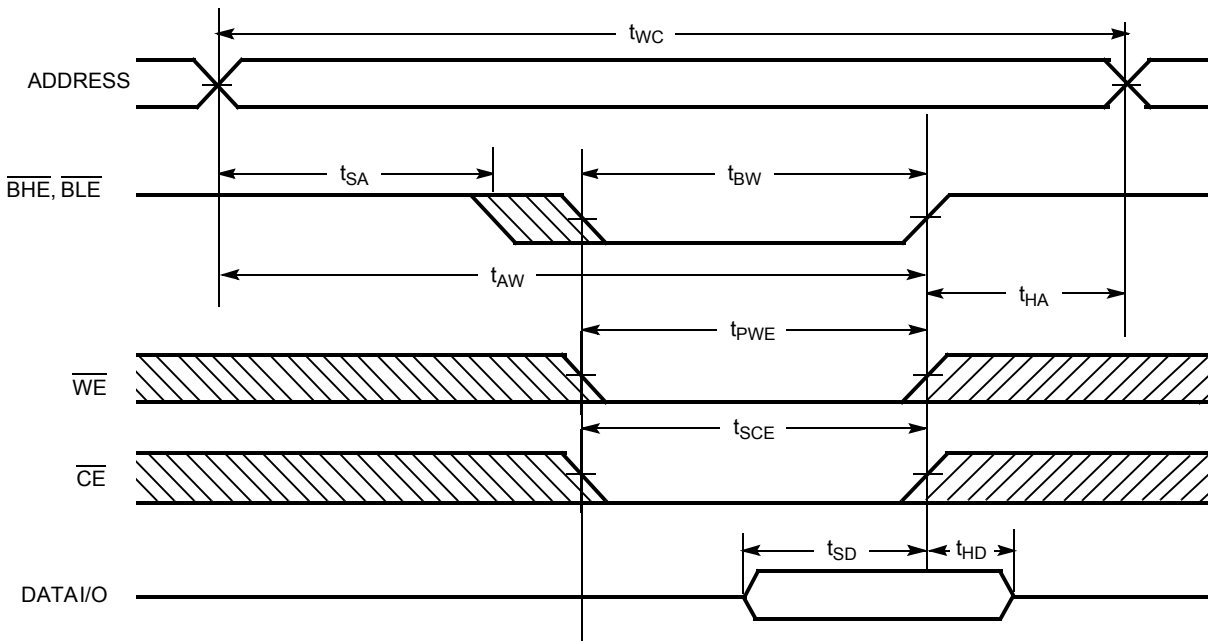

Figure 9. Write Cycle No. 2 ($\overline{\text{BLE}}$ or $\overline{\text{BHE}}$ Controlled)



Notes

- 18. Data I/O is high impedance if $\overline{\text{OE}}$ or $\overline{\text{BHE}}$ and $\overline{\text{BLE}} = V_{IH}$.
- 19. If $\overline{\text{CE}}$ goes HIGH simultaneously with $\overline{\text{WE}}$ going HIGH, the output remains in a high impedance state.

Switching Waveforms (continued)

Figure 10. Write Cycle No. 3 (\overline{WE} Controlled, \overline{OE} HIGH During Write) [20, 21]

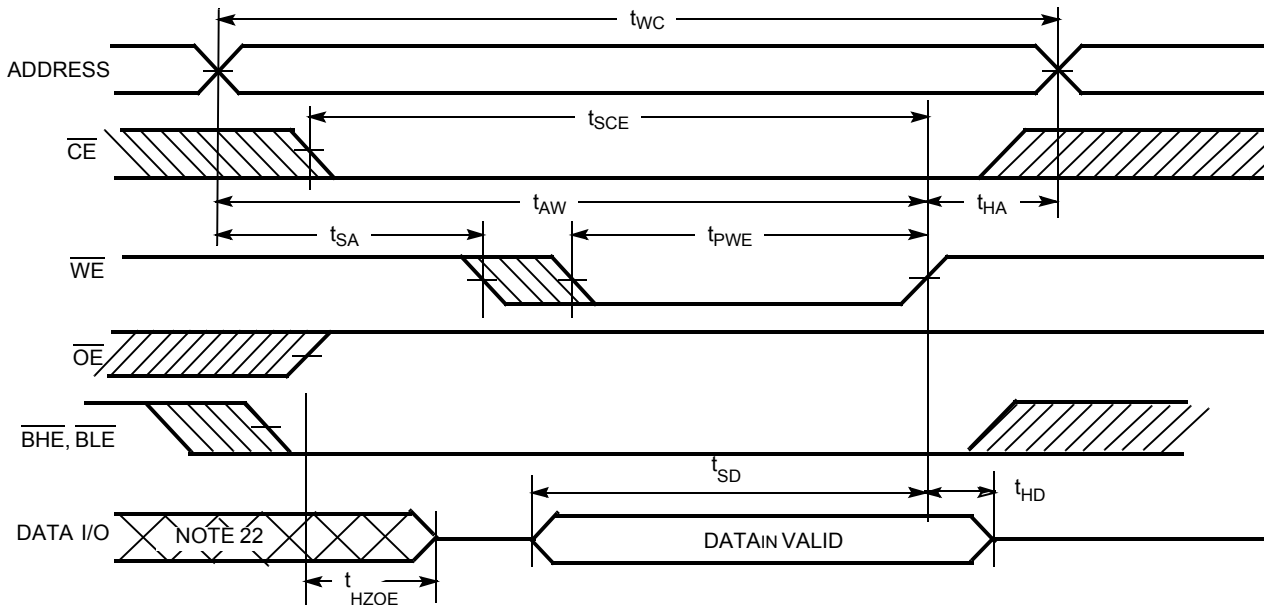
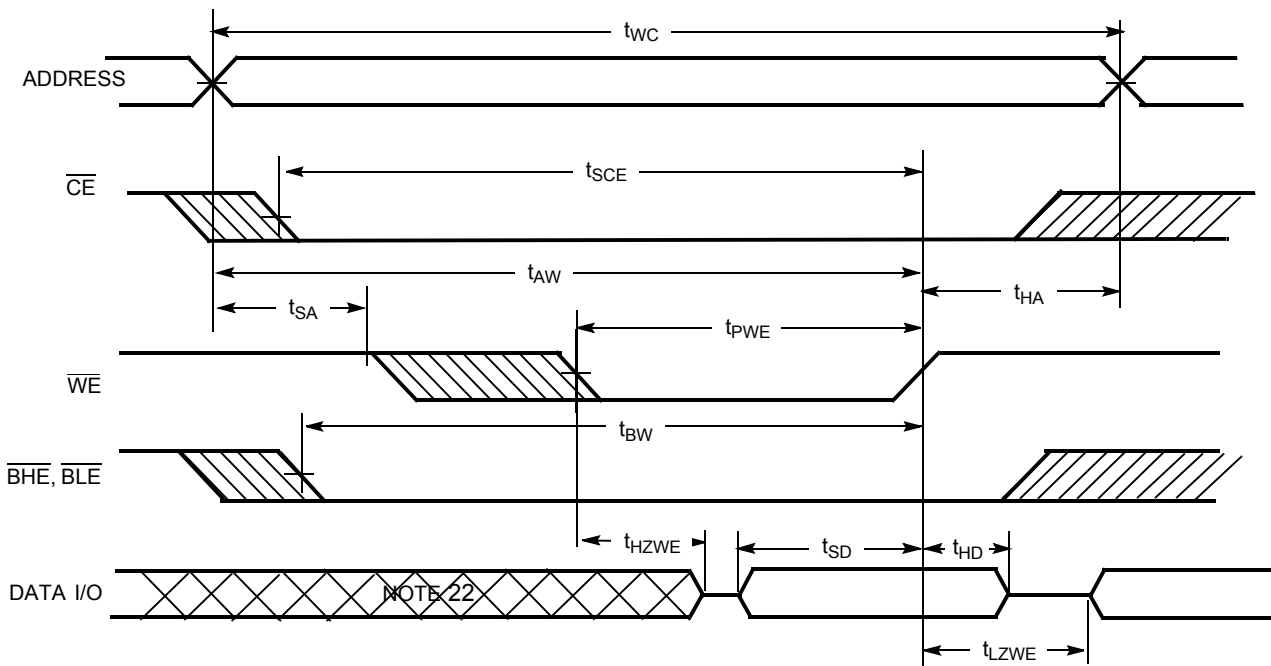

Figure 11. Write Cycle No. 4 (\overline{WE} Controlled, \overline{OE} LOW)



Notes

- 20. Data I/O is high impedance if \overline{OE} or \overline{BHE} and $\overline{BLE} = V_{IH}$.
- 21. If \overline{CE} goes HIGH simultaneously with \overline{WE} going HIGH, the output remains in a high impedance state.
- 22. During this period the I/Os are in the output state and input signals should not be applied.

Truth Table

\overline{CE}	\overline{OE}	\overline{WE}	\overline{BLE}	\overline{BHE}	I/O ₀ –I/O ₇	I/O ₈ –I/O ₁₅	Mode	Power
H	X	X	X	X	High Z	High Z	Power down	Standby (I _{SB})
L	L	H	L	L	Data out	Data out	Read all bits	Active (I _{CC})
L	L	H	L	H	Data out	High Z	Read lower bits only	Active (I _{CC})
L	L	H	H	L	High Z	Data out	Read upper bits only	Active (I _{CC})
L	X	L	L	L	Data in	Data in	Write all bits	Active (I _{CC})
L	X	L	L	H	Data in	High Z	Write lower bits only	Active (I _{CC})
L	X	L	H	L	High Z	Data in	Write upper bits only	Active (I _{CC})
L	H	H	X	X	High Z	High Z	Selected, outputs disabled	Active (I _{CC})
L	X	X	H	H	High Z	High Z	Selected, outputs disabled	Active (I _{CC})

Ordering Information

Speed (ns)	Ordering Code	Package Diagram	Package Type	Operating Range
10	CY7C1041DV33-10BVI	51-85150	48-ball VFBGA Pinout - 1 ^[23]	Industrial
	CY7C1041DV33-10BVXI		48-ball VFBGA (Pb-free) Pinout - 1 ^[23]	
	CY7C1041DV33-10BVJXI		48-ball VFBGA (Pb-free) Pinout - 2 ^[23]	
	CY7C1041DV33-10VXI	51-85082	44-pin (400-mil) Molded SOJ (Pb-free)	
	CY7C1041DV33-10ZSXI	51-85087	44-pin TSOP II (Pb-free)	

Contact your local Cypress sales representative for availability of these parts.

Ordering Code Definitions

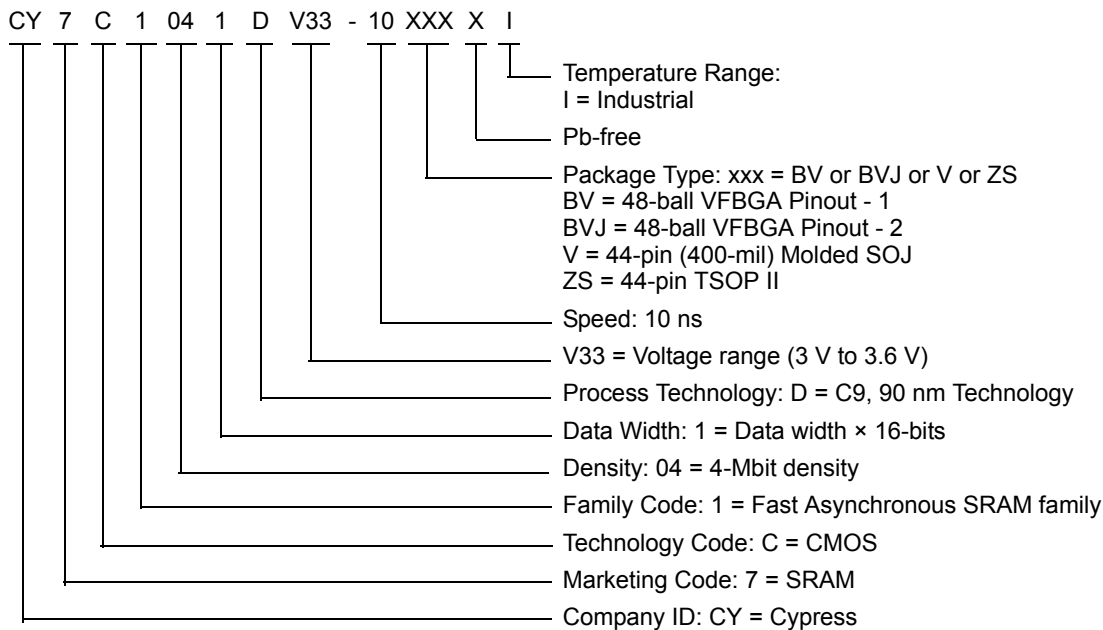

Note

23. Pinout 1 is compliant with CY7C1041CV33 and pinout 2 is JEDEC compliant. The difference between the two is that the higher and lower byte I/Os (I/O_[7:0] and I/O_[15:8] balls) are swapped.

Package Diagrams

Figure 12. 48-ball VFBGA (6 × 8 × 1 mm) BV48/BZ48 Package Outline, 51-85150

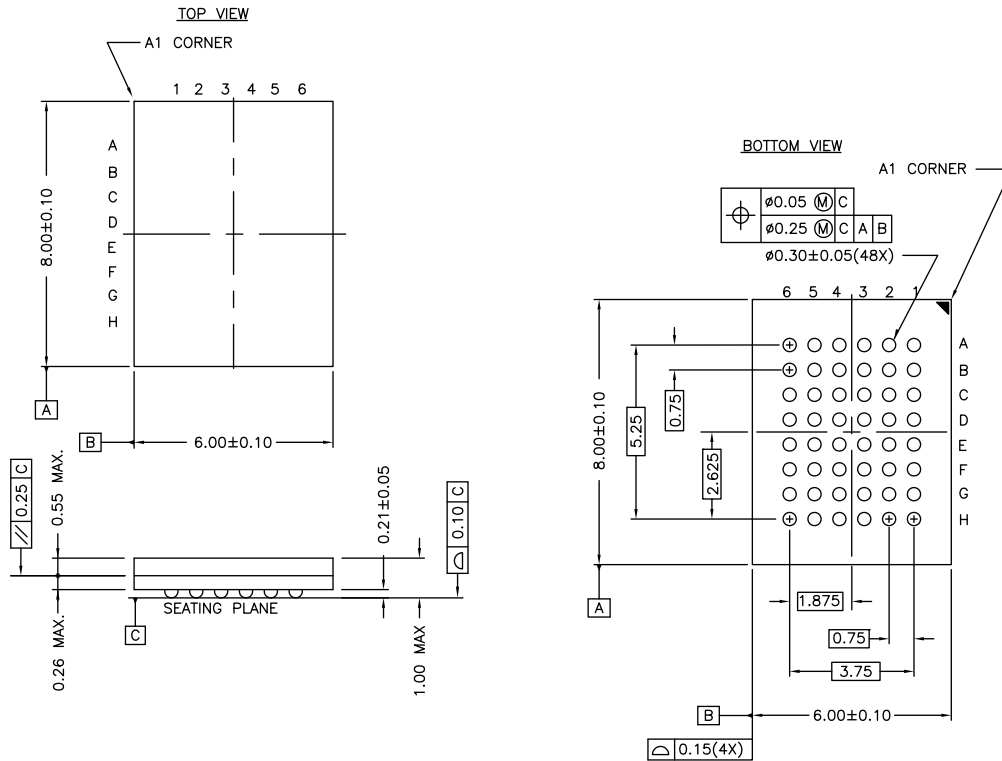

NOTE:
 PACKAGE WEIGHT: See Cypress Package Material Declaration Datasheet (PMDD)
 posted on the Cypress web.

51-85150 *H

Package Diagrams (continued)

Figure 13. 44-pin Molded SOJ (400-mil) V44.4 Package Outline, 51-85082

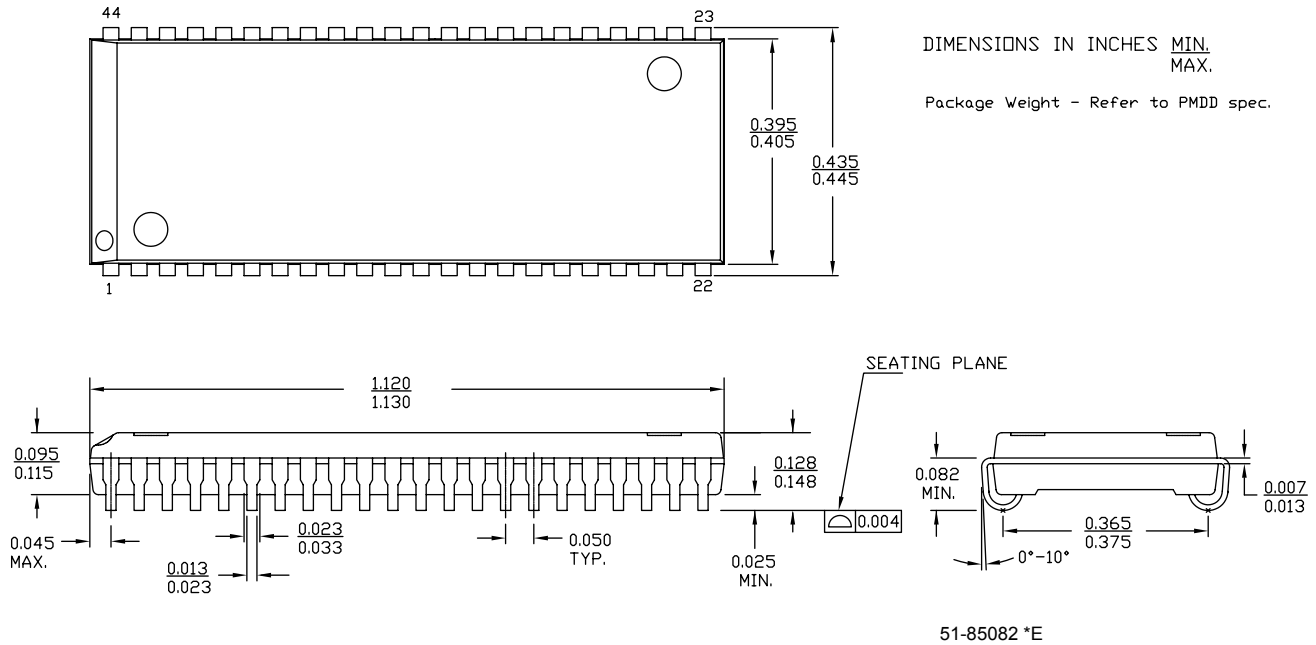
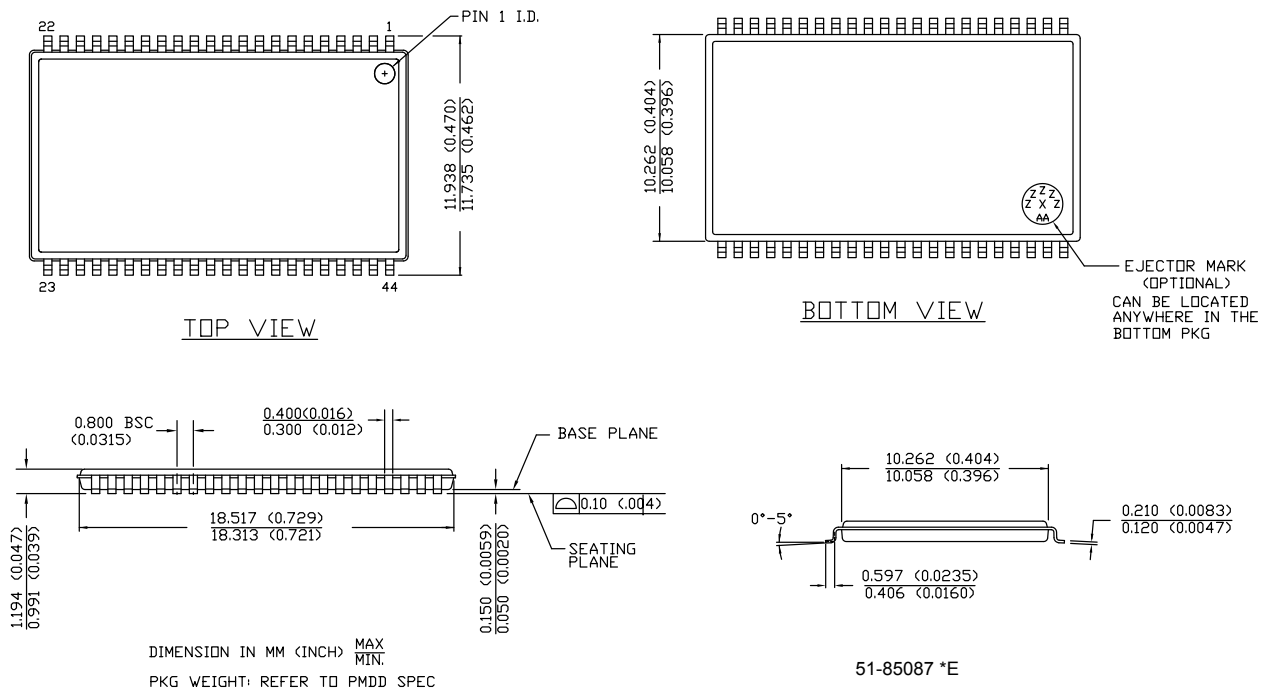

Figure 14. 44-pin TSOP Z44-II Package Outline, 51-85087



Acronyms

Acronym	Description
\overline{CE}	Chip Enable
CMOS	Complementary Metal Oxide Semiconductor
FBGA	Fine-Pitch Ball Grid Array
I/O	Input/Output
\overline{OE}	Output Enable
SOJ	Small Outline J-lead
SRAM	Static Random Access Memory
TSOP	Thin Small Outline Package
TTL	Transistor-Transistor Logic
VFBGA	Very Fine-Pitch Ball Grid Array
\overline{WE}	Write Enable

Document Conventions

Units of Measure

Symbol	Unit of Measure
°C	degree Celsius
MHz	megahertz
μA	microampere
μs	microsecond
mA	milliampere
mm	millimeter
ns	nanosecond
pF	picofarad
V	volt
W	watt

Document History Page

Document Title: CY7C1041DV33, 4-Mbit (256 K × 16) Static RAM Document Number: 38-05473				
Rev.	ECN No.	Orig. of Change	Submission Date	Description of Change
**	201560	SWI	See ECN	Advance Data sheet for C9 IPP
*A	233729	RKF	See ECN	1.AC, DC parameters are modified as per EROS(Spec # 01-2165) 2.Pb-free offering in the 'Ordering information'
*B	351117	PCI	See ECN	Changed from Advance to Preliminary Removed 15 and 20 ns Speed bin Corrected DC voltage (min) value in maximum ratings section from - 0.5 to - 0.3V Redefined I _{CC} values for Com'I and Ind'I temperature ranges I _{CC} (Com'I): Changed from 100, 80 and 67 mA to 90, 80 and 75 mA for 8, 10 and 12ns speed bins respectively I _{CC} (Ind'I): Changed from 80 and 67 mA to 90 and 85 mA for 10 and 12ns speed bins respectively Added Static Discharge Voltage and latch-up current spec Added V _{IH(max)} spec in Note# 2 Changed Note# 4 on AC Test Loads Changed reference voltage level for measurement of Hi-Z parameters from ±500 mV to ±200 mV Added Data Retention Characteristics/Waveform and footnote # 11, 12 Added Write Cycle (WE Controlled, OE HIGH During Write) Timing Diagram Changed Package Diagram name from 44-Pin TSOP II Z44 to 44-Pin TSOP II ZS44 and from 44-Pin (400-mil) Molded SOJ V34 to 44-Pin (400-mil) Molded SOJ V44 Changed part names from Z to ZS in the Ordering Information Table Added 8 ns Product Information Added Pin-Free Ordering Information Shaded Ordering Information Table
*C	446328	NXR	See ECN	Converted from Preliminary to Final Removed -8 speed bin Removed Commercial Operating Range product information Included Automotive Operating Range product information Updated Thermal Resistance table Updated footnote #8 on High-Z parameter measurement Updated the ordering information and replaced Package Name column with Package Diagram in the Ordering Information Table

Document History Page *(continued)*

Document Title: CY7C1041DV33, 4-Mbit (256 K × 16) Static RAM				
Document Number: 38-05473				
Rev.	ECN No.	Orig. of Change	Submission Date	Description of Change
*D	480177	VKN	See ECN	Added -10BVI product ordering code in the Ordering Information table
*E	2541850	VKN / PYRS	07/22/08	Added -10BVJXI part
*F	2752971	VKN	08/18/2009	Added Automotive-A information For 12 ns speed, changed I _{SB1} spec from 25 mA to 15 mA For 12 ns speed, changed t _{DOE} and t _{DBE} specs from 6 ns to 7 ns Updated ordering information table
*G	3034079	PRAS	09/20/2010	Added Ordering Code Definitions . Added Acronyms and Units of Measure . Minor edits
*H	3082285	HRP	11/09/2010	Corrected typo in Note 20.
*I	3149096	AJU	01/24/2011	No technical updates.
*J	3182129	HRP	03/02/2011	No technical updates
*K	3271586	PRAS	06/01/2011	Updated Features (Dislodged automotive part information to 001-69789). Updated Functional Description (Removed "For best practice recommendations, refer to the Cypress application note AN1064, SRAM System Guidelines."). Updated Selection Guide (Dislodged automotive part information to 001-69789). Updated Operating Range (Dislodged automotive part information to 001-69789). Updated DC Electrical Characteristics (Dislodged automotive part information to 001-69789). Updated AC Switching Characteristics (Dislodged automotive part information to 001-69789). Updated Data Retention Characteristics (Dislodged automotive part information to 001-69789). Updated Truth Table . Updated Ordering Information (Dislodged automotive part information to 001-69789). Updated in new template.
*L	3438781	TAVA	11/15/2011	Updated package drawing specs to current revision.
*M	4170254	MEMJ	10/22/2013	Updated Package Diagrams : spec 51-85150 – Changed revision from *G to *H. spec 51-85082 – Changed revision from *D to *E. spec 51-85087 – Changed revision from *D to *E. Updated in new template.
*N	4578500	MEMJ	12/16/2014	Added related documentation hyperlink in page 1. Updated footnote 13.

Sales, Solutions, and Legal Information

Worldwide Sales and Design Support

Cypress maintains a worldwide network of offices, solution centers, manufacturer's representatives, and distributors. To find the office closest to you, visit us at [Cypress Locations](#).

Products

Automotive	cypress.com/go/automotive
Clocks & Buffers	cypress.com/go/clocks
Interface	cypress.com/go/interface
Lighting & Power Control	cypress.com/go/powerpsoc cypress.com/go/plc
Memory	cypress.com/go/memory
PSoC	cypress.com/go/psoc
Touch Sensing	cypress.com/go/touch
USB Controllers	cypress.com/go/USB
Wireless/RF	cypress.com/go/wireless

PSoC[®] Solutions

[psoc.cypress.com/solutions](#)
[PSoC 1](#) | [PSoC 3](#) | [PSoC 4](#) | [PSoC 5LP](#)

Cypress Developer Community

[Community](#) | [Forums](#) | [Blogs](#) | [Video](#) | [Training](#)

Technical Support

[cypress.com/go/support](#)

© Cypress Semiconductor Corporation, 2004-2014. The information contained herein is subject to change without notice. Cypress Semiconductor Corporation assumes no responsibility for the use of any circuitry other than circuitry embodied in a Cypress product. Nor does it convey or imply any license under patent or other rights. Cypress products are not warranted nor intended to be used for medical, life support, life saving, critical control or safety applications, unless pursuant to an express written agreement with Cypress. Furthermore, Cypress does not authorize its products for use as critical components in life-support systems where a malfunction or failure may reasonably be expected to result in significant injury to the user. The inclusion of Cypress products in life-support systems application implies that the manufacturer assumes all risk of such use and in doing so indemnifies Cypress against all charges.

Any Source Code (software and/or firmware) is owned by Cypress Semiconductor Corporation (Cypress) and is protected by and subject to worldwide patent protection (United States and foreign), United States copyright laws and international treaty provisions. Cypress hereby grants to licensee a personal, non-exclusive, non-transferable license to copy, use, modify, create derivative works of, and compile the Cypress Source Code and derivative works for the sole purpose of creating custom software and or firmware in support of licensee product to be used only in conjunction with a Cypress integrated circuit as specified in the applicable agreement. Any reproduction, modification, translation, compilation, or representation of this Source Code except as specified above is prohibited without the express written permission of Cypress.

Disclaimer: CYPRESS MAKES NO WARRANTY OF ANY KIND, EXPRESS OR IMPLIED, WITH REGARD TO THIS MATERIAL, INCLUDING, BUT NOT LIMITED TO, THE IMPLIED WARRANTIES OF MERCHANTABILITY AND FITNESS FOR A PARTICULAR PURPOSE. Cypress reserves the right to make changes without further notice to the materials described herein. Cypress does not assume any liability arising out of the application or use of any product or circuit described herein. Cypress does not authorize its products for use as critical components in life-support systems where a malfunction or failure may reasonably be expected to result in significant injury to the user. The inclusion of Cypress' product in a life-support systems application implies that the manufacturer assumes all risk of such use and in doing so indemnifies Cypress against all charges.

Use may be limited by and subject to the applicable Cypress software license agreement.