



18-Mbit (512 K × 36/1 M × 18) Pipelined SRAM with NoBL™ Architecture

Features

- Pin-compatible and functionally equivalent to ZBT™
- Supports 250-MHz bus operations with zero wait states
 - Available speed grades are 250, 200, and 167 MHz
- Internally self-timed output buffer control to eliminate the need to use asynchronous OE
- Fully registered (inputs and outputs) for pipelined operation
- Byte write capability
- 3.3 V core power supply (V_{DD})
- 3.3 V/2.5 V I/O power supply (V_{DDQ})
- Fast clock-to-output times
 - 2.6 ns (for 250 MHz device)
- Clock enable ($\overline{\text{CEN}}$) pin to suspend operation
- Synchronous self-timed writes
- Available in JEDEC-standard Pb-free 100-pin TQFP, Pb-free and non Pb-free 65-ball FBGA package
- IEEE 1149.1 JTAG-compatible boundary scan
- Burst capability – linear or interleaved burst order
- “ZZ” sleep mode option and stop clock option

Functional Description

The CY7C1370D and CY7C1372D are 3.3 V, 512 K × 36 and 1 M × 18 synchronous pipelined burst SRAMs with No Bus Latency™ (NoBL™) logic, respectively. They are designed to support unlimited true back-to-back read/write operations with no wait states. The CY7C1370D and CY7C1372D are equipped with the advanced (NoBL) logic required to enable consecutive read/write operations with data being transferred on every clock cycle. This feature dramatically improves the throughput of data in systems that require frequent write/read transitions. The CY7C1370D and CY7C1372D are pin compatible and functionally equivalent to ZBT devices.

All synchronous inputs pass through input registers controlled by the rising edge of the clock. All data outputs pass through output registers controlled by the rising edge of the clock. The clock input is qualified by the clock enable (CEN) signal, which when deasserted suspends operation and extends the previous clock cycle.

Write operations are controlled by the byte write selects (BW_a–BW_d for CY7C1370D and BW_a–BW_b for CY7C1372D) and a write enable ($\overline{\text{WE}}$) input. All writes are conducted with on-chip synchronous self-timed write circuitry.

Three synchronous chip enables ($\overline{\text{CE}}_1$, CE₂, $\overline{\text{CE}}_3$) and an asynchronous output enable ($\overline{\text{OE}}$) provide for easy bank selection and output tri-state control. In order to avoid bus contention, the output drivers are synchronously tristated during the data portion of a write sequence.

For a complete list of related documentation, click [here](#).

Selection Guide

Description	250 MHz	200 MHz	167 MHz	Unit
Maximum access time	2.6	3.0	3.4	ns
Maximum operating current	350	300	275	mA
Maximum CMOS standby current	70	70	70	mA

Errata: For information on silicon errata, see “Errata” on page 30. Details include trigger conditions, devices affected, and proposed workaround.

Logic Block Diagram – CY7C1370D

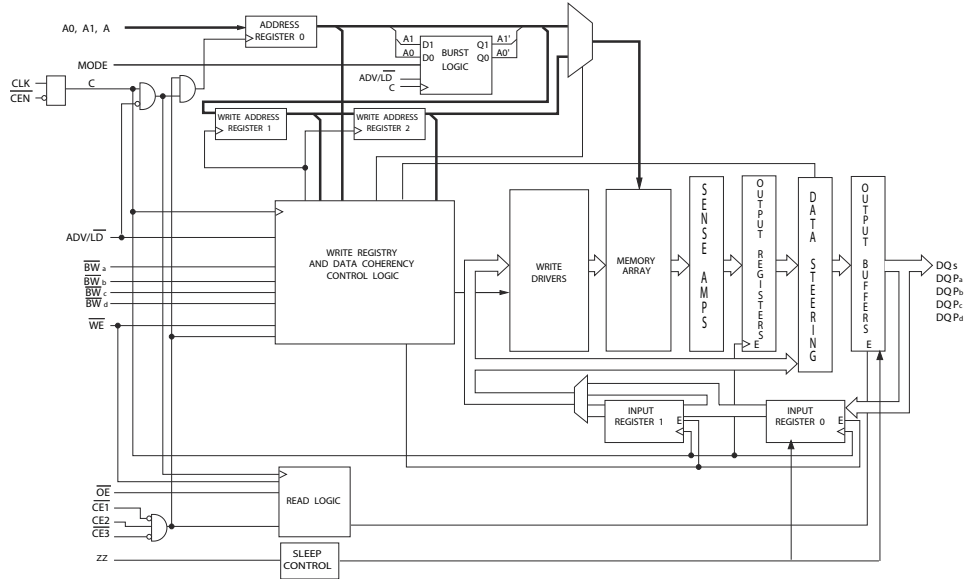

Logic Block Diagram – CY7C1372D

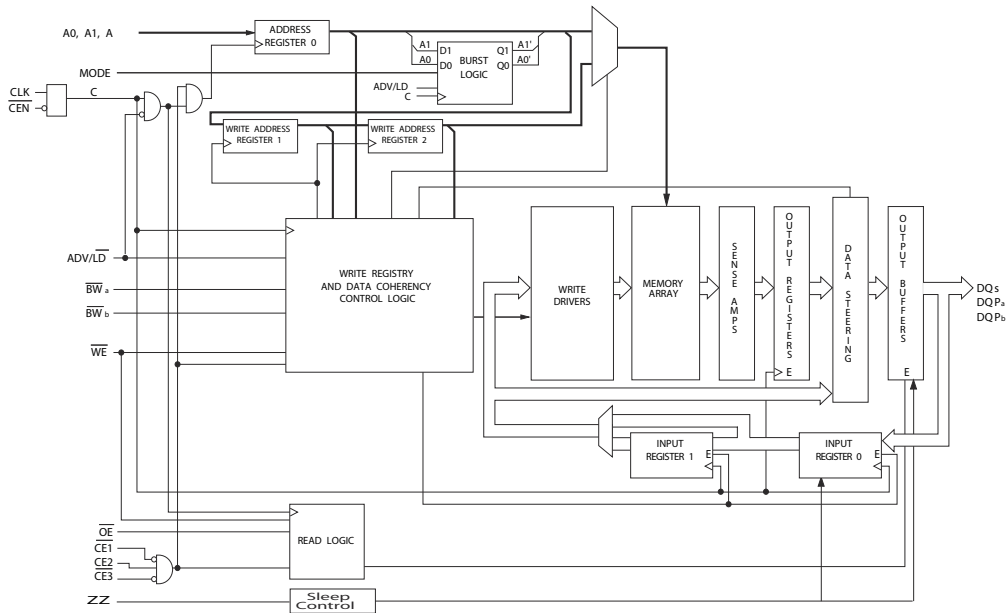

Contents

Pin Configurations	4	Identification Codes	18
Pin Definitions	6	Boundary Scan Order	19
Functional Overview	8	Maximum Ratings	20
Single Read Accesses	8	Operating Range	20
Burst Read Accesses	8	Neutron Soft Error Immunity	20
Single Write Accesses	8	Electrical Characteristics	20
Burst Write Accesses	8	Capacitance	21
Sleep Mode	9	Thermal Resistance	21
Interleaved Burst Address Table	9	AC Test Loads and Waveforms	22
Linear Burst Address Table	9	Switching Characteristics	23
ZZ Mode Electrical Characteristics	9	Switching Waveforms	24
Truth Table	10	Ordering Information	26
Partial Write Cycle Description	11	Ordering Code Definitions	26
IEEE 1149.1 Serial Boundary Scan (JTAG [17])	12	Package Diagrams	27
Disabling the JTAG Feature	12	Acronyms	29
Test Access Port (TAP)	12	Document Conventions	29
PERFORMING A TAP RESET	12	Units of Measure	29
TAP REGISTERS	12	Errata	30
TAP Instruction Set	13	Part Numbers Affected	30
TAP Controller State Diagram	14	Product Status	30
TAP Controller Block Diagram	15	Ram9 NoBL ZZ Pin & JTAG Issues	
TAP Timing	15	Errata Summary	30
TAP AC Switching Characteristics	16	Document History Page	32
3.3 V TAP AC Test Conditions	17	Sales, Solutions, and Legal Information	34
3.3 V TAP AC Output Load Equivalent	17	Worldwide Sales and Design Support	34
2.5 V TAP AC Test Conditions	17	Products	34
2.5 V TAP AC Output Load Equivalent	17	PSoC® Solutions	34
TAP DC Electrical Characteristics and		Cypress Developer Community	34
Operating Conditions	17	Technical Support	34
Identification Register Definitions	18		
Scan Register Sizes	18		

Pin Configurations

Figure 1. 100-pin TQFP (14 × 20 × 1.4 mm) pinout ^[1]

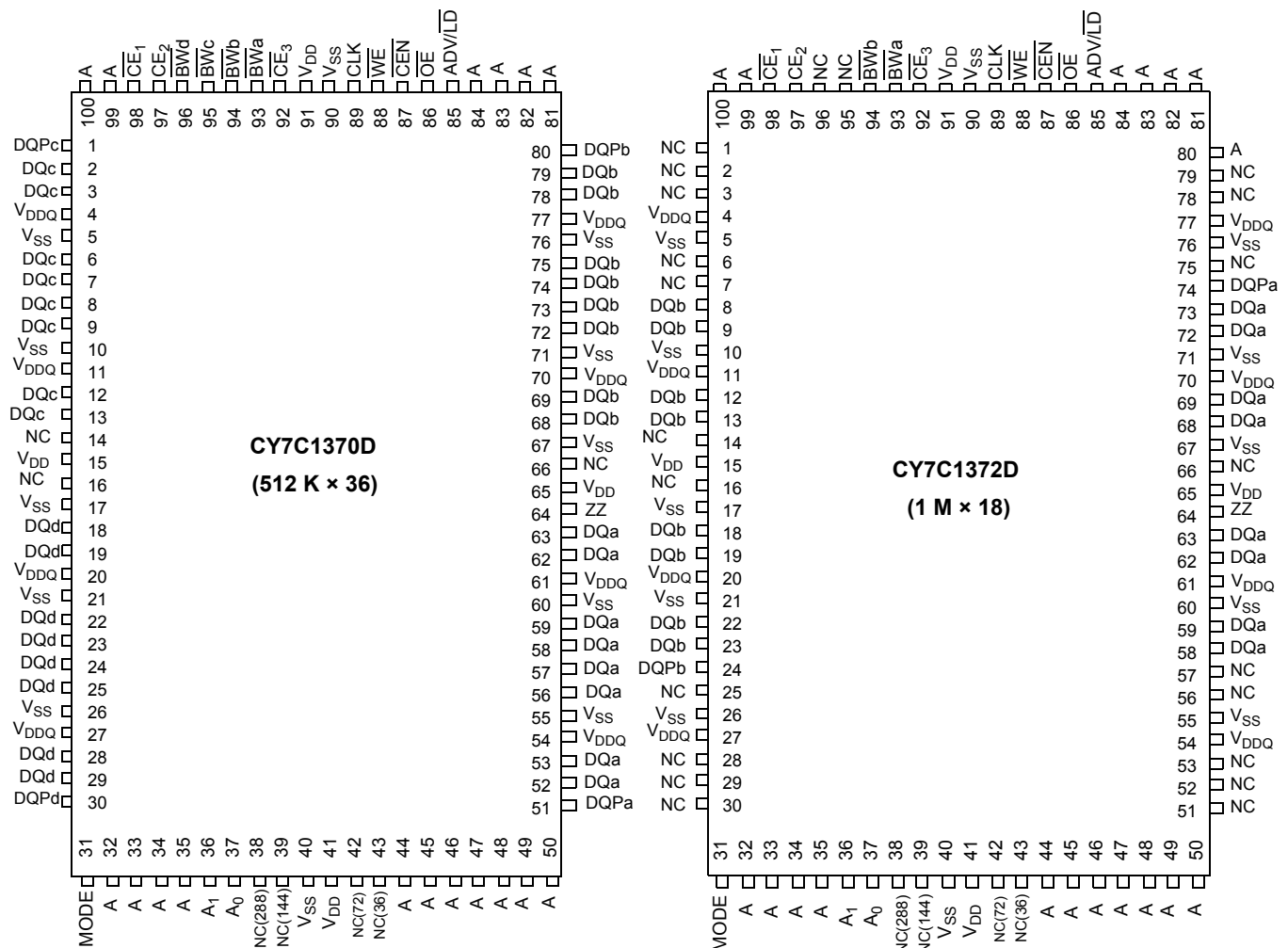

Note

- Errata:** The ZZ pin (Pin 64) needs to be externally connected to ground. For more information, see "Errata" on page 30.

Pin Configurations (continued)

Figure 2. 165-ball FBGA (13 × 15 × 1.4 mm) pinout [2, 3]

CY7C1370D (512 K × 36)

	1	2	3	4	5	6	7	8	9	10	11
A	NC/576M	A	\overline{CE}_1	\overline{BW}_c	\overline{BW}_b	\overline{CE}_3	\overline{CEN}	ADV/LD	A	A	NC
B	NC/1G	A	CE2	\overline{BW}_d	\overline{BW}_a	CLK	\overline{WE}	\overline{OE}	A	A	NC
C	DQP _c	NC	V _{DDQ}	V _{SS}	V _{SS}	V _{SS}	V _{SS}	V _{SS}	V _{DDQ}	NC	DQP _b
D	DQ _c	DQ _c	V _{DDQ}	V _{DD}	V _{SS}	V _{SS}	V _{SS}	V _{DD}	V _{DDQ}	DQ _b	DQ _b
E	DQ _c	DQ _c	V _{DDQ}	V _{DD}	V _{SS}	V _{SS}	V _{SS}	V _{DD}	V _{DDQ}	DQ _b	DQ _b
F	DQ _c	DQ _c	V _{DDQ}	V _{DD}	V _{SS}	V _{SS}	V _{SS}	V _{DD}	V _{DDQ}	DQ _b	DQ _b
G	DQ _c	DQ _c	V _{DDQ}	V _{DD}	V _{SS}	V _{SS}	V _{SS}	V _{DD}	V _{DDQ}	DQ _b	DQ _b
H	NC	NC	NC	V _{DD}	V _{SS}	V _{SS}	V _{SS}	V _{DD}	NC	NC	ZZ
J	DQ _d	DQ _d	V _{DDQ}	V _{DD}	V _{SS}	V _{SS}	V _{SS}	V _{DD}	V _{DDQ}	DQ _a	DQ _a
K	DQ _d	DQ _d	V _{DDQ}	V _{DD}	V _{SS}	V _{SS}	V _{SS}	V _{DD}	V _{DDQ}	DQ _a	DQ _a
L	DQ _d	DQ _d	V _{DDQ}	V _{DD}	V _{SS}	V _{SS}	V _{SS}	V _{DD}	V _{DDQ}	DQ _a	DQ _a
M	DQ _d	DQ _d	V _{DDQ}	V _{DD}	V _{SS}	V _{SS}	V _{SS}	V _{DD}	V _{DDQ}	DQ _a	DQ _a
N	DQP _d	NC	V _{DDQ}	V _{SS}	NC	NC	NC	V _{SS}	V _{DDQ}	NC	DQP _a
P	NC/144M	NC/72M	A	A	TDI	A1	TDO	A	A	A	NC/288M
R	MODE	NC/36M	A	A	TMS	A0	TCK	A	A	A	A

Notes

2. **Errata:** The ZZ ball (H11) needs to be externally connected to ground. For more information, see "Errata" on page 30.
3. **Errata:** The JTAG testing should be performed with these devices in BYPASS mode as the JTAG functionality is not guaranteed. For more information, see "Errata" on page 30.

Pin Definitions

Pin Name	I/O Type	Pin Description
A ₀ , A ₁ , A	Input-synchronous	Address inputs used to select one of the address locations. Sampled at the rising edge of the CLK.
\overline{BW}_a , \overline{BW}_b , \overline{BW}_c , \overline{BW}_d	Input-synchronous	Byte write select inputs, active LOW. Qualified with \overline{WE} to conduct writes to the SRAM. Sampled on the rising edge of CLK. \overline{BW}_a controls DQ _a and DQP _a , \overline{BW}_b controls DQ _b and DQP _b , \overline{BW}_c controls DQ _c and DQP _c , \overline{BW}_d controls DQ _d and DQP _d .
\overline{WE}	Input-synchronous	Write enable input, active LOW. Sampled on the rising edge of CLK if \overline{CEN} is active LOW. This signal must be asserted LOW to initiate a write sequence.
ADV/LD	Input-synchronous	Advance/load input used to advance the on-chip address counter or load a new address. When HIGH (and \overline{CEN} is asserted LOW) the internal burst counter is advanced. When LOW, a new address can be loaded into the device for an access. After being deselected, ADV/LD should be driven LOW in order to load a new address.
CLK	Input-clock	Clock input. Used to capture all synchronous inputs to the device. CLK is qualified with \overline{CEN} . CLK is only recognized if \overline{CEN} is active LOW.
\overline{CE}_1	Input-synchronous	Chip enable 1 input, active LOW. Sampled on the rising edge of CLK. Used in conjunction with \overline{CE}_2 and \overline{CE}_3 to select/deselect the device.
\overline{CE}_2	Input-synchronous	Chip enable 2 input, active HIGH. Sampled on the rising edge of CLK. Used in conjunction with \overline{CE}_1 and \overline{CE}_3 to select/deselect the device.
\overline{CE}_3	Input-synchronous	Chip enable 3 input, active LOW. Sampled on the rising edge of CLK. Used in conjunction with \overline{CE}_1 and \overline{CE}_2 to select/deselect the device.
\overline{OE}	Input-asynchronous	Output enable, active LOW. Combined with the synchronous logic block inside the device to control the direction of the I/O pins. When LOW, the I/O pins are allowed to behave as outputs. When deasserted HIGH, I/O pins are tristated, and act as input data pins. \overline{OE} is masked during the data portion of a write sequence, during the first clock when emerging from a deselected state and when the device has been deselected.
\overline{CEN}	Input-synchronous	Clock enable input, active LOW. When asserted LOW the clock signal is recognized by the SRAM. When deasserted HIGH the clock signal is masked. Since deasserting \overline{CEN} does not deselect the device, \overline{CEN} can be used to extend the previous cycle when required.
DQ _s	I/O-synchronous	Bidirectional data I/O lines. As inputs, they feed into an on-chip data register that is triggered by the rising edge of CLK. As outputs, they deliver the data contained in the memory location specified by A _[17:0] during the previous clock rise of the read cycle. The direction of the pins is controlled by \overline{OE} and the internal control logic. When \overline{OE} is asserted LOW, the pins can behave as outputs. When HIGH, DQ _a –DQ _d are placed in a tristate condition. The outputs are automatically tristated during the data portion of a write sequence, during the first clock when emerging from a deselected state, and when the device is deselected, regardless of the state of \overline{OE} .
DQP _x	I/O-synchronous	Bidirectional data parity I/O lines. Functionally, these signals are identical to DQ _s . During write sequences, DQP _a is controlled by \overline{BW}_a , DQP _b is controlled by \overline{BW}_b , DQP _c is controlled by \overline{BW}_c , and DQP _d is controlled by \overline{BW}_d .
MODE	Input strap pin	Mode input. Selects the burst order of the device. Tied HIGH selects the interleaved burst order. Pulled LOW selects the linear burst order. MODE should not change states during operation. When left floating MODE will default HIGH, to an interleaved burst order.

Pin Definitions (continued)

Pin Name	I/O Type	Pin Description
TDO ^[4]	JTAG serial output synchronous	Serial data-out to the JTAG circuit. Delivers data on the negative edge of TCK.
TDI ^[4]	JTAG serial input synchronous	Serial data-in to the JTAG circuit. Sampled on the rising edge of TCK.
TMS ^[4]	Test mode select synchronous	This pin controls the test access port state machine. Sampled on the rising edge of TCK.
TCK ^[4]	JTAG-clock	Clock input to the JTAG circuitry.
V _{DD}	Power supply	Power supply inputs to the core of the device.
V _{DDQ}	I/O power supply	Power supply for the I/O circuitry.
V _{SS}	Ground	Ground for the device. Should be connected to ground of the system.
NC	–	No connects. This pin is not connected to the die.
NC/(36M, 72M, 144M, 288M, 576M, 1G)	–	These pins are not connected. They will be used for expansion to the 36M, 72M, 144M, 288M, 576M and 1G densities.
ZZ ^[5]	Input-asynchronous	ZZ “sleep” input. This active HIGH input places the device in a non-time critical “sleep” condition with data integrity preserved. During normal operation, this pin can be connected to V _{SS} or left floating. ZZ pin has an internal pull down.

Note

4. **Errata:** The JTAG testing should be performed with these devices in BYPASS mode as the JTAG functionality is not guaranteed. For more information, see “Errata” on page 30.
5. **Errata:** The ZZ pin needs to be externally connected to ground. For more information, see “Errata” on page 30.

Functional Overview

The CY7C1370D and CY7C1372D are synchronous-pipelined burst NoBL SRAMs designed specifically to eliminate wait states during write/read transitions. All synchronous inputs pass through input registers controlled by the rising edge of the clock. The clock signal is qualified with the clock enable input signal (CEN). If CEN is HIGH, the clock signal is not recognized and all internal states are maintained. All synchronous operations are qualified with CEN. All data outputs pass through output registers controlled by the rising edge of the clock. Maximum access delay from the clock rise (t_{CO}) is 2.6 ns (250-MHz device).

Accesses can be initiated by asserting all three chip enables (\overline{CE}_1 , \overline{CE}_2 , \overline{CE}_3) active at the rising edge of the clock. If clock enable (CEN) is active LOW and ADV/LD is asserted LOW, the address presented to the device will be latched. The access can either be a read or write operation, depending on the status of the write enable (WE). BW_X can be used to conduct byte write operations.

Write operations are qualified by the write enable (\overline{WE}). All writes are simplified with on-chip synchronous self-timed write circuitry.

Three synchronous chip enables (\overline{CE}_1 , \overline{CE}_2 , \overline{CE}_3) and an asynchronous output enable (\overline{OE}) simplify depth expansion. All operations (reads, writes, and deselections) are pipelined. ADV/LD should be driven LOW once the device has been deselected in order to load a new address for the next operation.

Single Read Accesses

A read access is initiated when the following conditions are satisfied at clock rise: (1) CEN is asserted LOW, (2) \overline{CE}_1 , \overline{CE}_2 , and \overline{CE}_3 are all asserted active, (3) the write enable input signal WE is deasserted HIGH, and (4) ADV/LD is asserted LOW. The address presented to the address inputs is latched into the address register and presented to the memory core and control logic. The control logic determines that a read access is in progress and allows the requested data to propagate to the input of the output register. At the rising edge of the next clock the requested data is allowed to propagate through the output register and onto the data bus within 2.6 ns (250-MHz device) provided \overline{OE} is active LOW. After the first clock of the read access the output buffers are controlled by \overline{OE} and the internal control logic. \overline{OE} must be driven LOW in order for the device to drive out the requested data. During the second clock, a subsequent operation (read/write/deselect) can be initiated. Deselecting the device is also pipelined. Therefore, when the SRAM is deselected at clock rise by one of the chip enable signals, its output will tristate following the next clock rise.

Burst Read Accesses

The CY7C1370D and CY7C1372D have an on-chip burst counter that allows the user the ability to supply a single address and conduct up to four reads without reasserting the address inputs. ADV/LD must be driven LOW in order to load a new address into the SRAM, as described in the [Single Read Accesses](#) section above. The sequence of the burst counter is determined by the MODE input signal. A LOW input on MODE selects a linear burst mode, a HIGH selects an interleaved burst sequence. Both burst counters use A0 and A1 in the burst sequence, and will wrap-around when incremented sufficiently. A HIGH input on ADV/LD will increment the internal burst counter

regardless of the state of chip enables inputs or \overline{WE} . \overline{WE} is latched at the beginning of a burst cycle. Therefore, the type of access (read or write) is maintained throughout the burst sequence.

Single Write Accesses

Write access are initiated when the following conditions are satisfied at clock rise: (1) CEN is asserted LOW, (2) \overline{CE}_1 , \overline{CE}_2 , and \overline{CE}_3 are all asserted active, and (3) the write signal WE is asserted LOW. The address presented is loaded into the address register. The write signals are latched into the control logic block.

On the subsequent clock rise the data lines are automatically tristated regardless of the state of the \overline{OE} input signal. This allows the external logic to present the data on DQ and DQP ($DQ_{a,b,c,d}/DQP_{a,b,c,d}$ for CY7C1370D and $DQ_{a,b}/DQP_{a,b}$ for CY7C1372D). In addition, the address for the subsequent access (read/write/deselect) is latched into the address register (provided the appropriate control signals are asserted).

On the next clock rise the data presented to DQ and DQP ($DQ_{a,b,c,d}/DQP_{a,b,c,d}$ for CY7C1370D & $DQ_{a,b}/DQP_{a,b}$ for CY7C1372D) (or a subset for byte write operations, see Write Cycle Description table for details) inputs is latched into the device and the write is complete.

The data written during the write operation is controlled by \overline{BW} ($\overline{BW}_{a,b,c,d}$ for CY7C1370D and $\overline{BW}_{a,b}$ for CY7C1372D) signals. The CY7C1370D/CY7C1372D provides byte write capability that is described in the [Write Cycle Description](#) table. Asserting the write enable input (WE) with the selected byte write select (BW) input will selectively write to only the desired bytes. Bytes not selected during a byte write operation will remain unaltered. A synchronous self-timed write mechanism has been provided to simplify the write operations. Byte write capability has been included in order to greatly simplify read/modify/write sequences, which can be reduced to simple byte write operations.

Because the CY7C1370D and CY7C1372D are common I/O devices, data should not be driven into the device while the outputs are active. The output enable (\overline{OE}) can be deasserted HIGH before presenting data to the DQ and DQP ($DQ_{a,b,c,d}/DQP_{a,b,c,d}$ for CY7C1370D and $DQ_{a,b}/DQP_{a,b}$ for CY7C1372D) inputs. Doing so will tri-state the output drivers. As a safety precaution, DQ and DQP ($DQ_{a,b,c,d}/DQP_{a,b,c,d}$ for CY7C1370D and $DQ_{a,b}/DQP_{a,b}$ for CY7C1372D) are automatically tristated during the data portion of a write cycle, regardless of the state of \overline{OE} .

Burst Write Accesses

The CY7C1370D/CY7C1372D has an on-chip burst counter that allows the user the ability to supply a single address and conduct up to four write operations without reasserting the address inputs. ADV/LD must be driven LOW in order to load the initial address, as described in the [Single Write Accesses](#) section above. When ADV/LD is driven HIGH on the subsequent clock rise, the chip enables (\overline{CE}_1 , \overline{CE}_2 , and \overline{CE}_3) and WE inputs are ignored and the burst counter is incremented. The correct BW ($\overline{BW}_{a,b,c,d}$ for CY7C1370D and $\overline{BW}_{a,b}$ for CY7C1372D) inputs must be driven in each cycle of the burst write in order to write the correct bytes of data.

Sleep Mode

The ZZ input pin is an asynchronous input. Asserting ZZ places the SRAM in a power conservation “sleep” mode. Two clock cycles are required to enter into or exit from this “sleep” mode. While in this mode, data integrity is guaranteed. Accesses pending when entering the “sleep” mode are not considered valid nor is the completion of the operation guaranteed. The device must be deselected prior to entering the “sleep” mode. CE_1 , CE_2 , and CE_3 , must remain inactive for the duration of t_{ZZREC} after the ZZ input returns LOW.

Linear Burst Address Table

(MODE = GND)

First Address A1:A0	Second Address A1:A0	Third Address A1:A0	Fourth Address A1:A0
00	01	10	11
01	10	11	00
10	11	00	01
11	00	01	10

Interleaved Burst Address Table

(MODE = Floating or V_{DD})

First Address A1:A0	Second Address A1:A0	Third Address A1:A0	Fourth Address A1:A0
00	01	10	11
01	00	11	10
10	11	00	01
11	10	01	00

ZZ Mode Electrical Characteristics

Parameter	Description	Test Conditions	Min	Max	Unit
I_{DDZZ}	Sleep mode standby current	$ZZ \geq V_{DD} - 0.2 V$	–	80	mA
t_{ZZS}	Device operation to ZZ	$ZZ \geq V_{DD} - 0.2 V$	–	$2t_{CYC}$	ns
t_{ZZREC}	ZZ recovery time	$ZZ \leq 0.2 V$	$2t_{CYC}$	–	ns
t_{ZZI}	ZZ active to sleep current	This parameter is sampled	–	$2t_{CYC}$	ns
t_{RZZI}	ZZ Inactive to exit sleep current	This parameter is sampled	0	–	ns

Truth Table

The Truth Table for CY7C1370D and CY7C1372D follows. [6, 7, 8, 9, 10, 11, 12]

Operation	Address Used	\overline{CE}	\overline{ZZ}	$\overline{ADV/LD}$	\overline{WE}	\overline{BW}_x	\overline{OE}	\overline{CEN}	CLK	DQ
Deselect cycle	None	H	L	L	X	X	X	L	L-H	Tri-state
Continue deselect cycle	None	X	L	H	X	X	X	L	L-H	Tri-state
Read cycle (begin burst)	External	L	L	L	H	X	L	L	L-H	Data out (Q)
Read cycle (continue burst)	Next	X	L	H	X	X	L	L	L-H	Data out (Q)
NOP/dummy read (begin burst)	External	L	L	L	H	X	H	L	L-H	Tri-state
Dummy read (continue burst)	Next	X	L	H	X	X	H	L	L-H	Tri-state
Write cycle (begin burst)	External	L	L	L	L	L	X	L	L-H	Data in (D)
Write cycle (continue burst)	Next	X	L	H	X	L	X	L	L-H	Data in (D)
NOP/write abort (begin burst)	None	L	L	L	L	H	X	L	L-H	Tri-state
Write abort (continue burst)	Next	X	L	H	X	H	X	L	L-H	Tri-state
Ignore clock edge (stall)	Current	X	L	X	X	X	X	H	L-H	-
Sleep mode	None	X	H	X	X	X	X	X	X	Tri-state

Notes

6. X = "Don't Care", H = Logic HIGH, L = Logic LOW, \overline{CE} stands for ALL Chip Enables active. $\overline{BW}_x = L$ signifies at least one Byte Write Select is active, $\overline{BW}_x = \text{Valid}$ signifies that the desired byte write selects are asserted, see Write Cycle Description table for details.
7. Write is defined by \overline{WE} and \overline{BW}_x . See Write Cycle Description table for details.
8. When a write cycle is detected, all I/Os are tristated, even during byte writes.
9. The DQ and DQP pins are controlled by the current cycle and the \overline{OE} signal.
10. $\overline{CEN} = H$ inserts wait states.
11. Device will power-up deselected and the I/Os in a tristate condition, regardless of \overline{OE} .
12. \overline{OE} is asynchronous and is not sampled with the clock rise. It is masked internally during write cycles. During a read cycle DQ_s and $DQP_x = \text{Tri-state}$ when \overline{OE} is inactive or when the device is deselected, and $DQ_s = \text{data}$ when \overline{OE} is active.

Partial Write Cycle Description

The Partial Write Cycle Description for CY7C1370D follows. [13, 14, 15, 16]

Function (CY7C1370D)	\overline{WE}	\overline{BW}_d	\overline{BW}_c	\overline{BW}_b	\overline{BW}_a
Read	H	X	X	X	X
Write – No bytes written	L	H	H	H	H
Write Byte a – (DQ _a and DQP _a)	L	H	H	H	L
Write Byte b – (DQ _b and DQP _b)	L	H	H	L	H
Write Bytes b, a	L	H	H	L	L
Write Byte c – (DQ _c and DQP _c)	L	H	L	H	H
Write Bytes c, a	L	H	L	H	L
Write Bytes c, b	L	H	L	L	H
Write Bytes c, b, a	L	H	L	L	L
Write Byte d – (DQ _d and DQP _d)	L	L	H	H	H
Write Bytes d, a	L	L	H	H	L
Write Bytes d, b	L	L	H	L	H
Write Bytes d, b, a	L	L	H	L	L
Write Bytes d, c	L	L	L	H	H
Write Bytes d, c, a	L	L	L	H	L
Write Bytes d, c, b	L	L	L	L	H
Write All Bytes	L	L	L	L	L

Partial Write Cycle Description

The Partial Write Cycle Description for CY7C1372D follows. [13, 14, 15, 16]

Function (CY7C1372D)	\overline{WE}	\overline{BW}_b	\overline{BW}_a
Read	H	X	X
Write – No Bytes Written	L	H	H
Write Byte a – (DQ _a and DQP _a)	L	H	L
Write Byte b – (DQ _b and DQP _b)	L	L	H
Write Both Bytes	L	L	L

Notes

13. X = "Don't Care", H = Logic HIGH, L = Logic LOW, \overline{CE} stands for ALL Chip Enables active. $\overline{BW}_x = L$ signifies at least one Byte Write Select is active, $\overline{BW}_x = \text{Valid}$ signifies that the desired byte write selects are asserted, see Truth Table on page 10 for details.
14. Write is defined by \overline{WE} and \overline{BW}_x . See Write Cycle Description table for details.
15. When a write cycle is detected, all I/Os are tristated, even during byte writes.
16. Table only lists a partial listing of the byte write combinations. Any Combination of \overline{BW}_x is valid Appropriate write will be done based on which byte write is active.

IEEE 1149.1 Serial Boundary Scan (JTAG ^[17])

The CY7C1370D incorporates a serial boundary scan test access port (TAP). This part is fully compliant with 1149.1. The TAP operates using JEDEC-standard 3.3 V or 2.5 V I/O logic levels.

The CY7C1370D contains a TAP controller, instruction register, boundary scan register, bypass register, and ID register.

Disabling the JTAG Feature

It is possible to operate the SRAM without using the JTAG feature. To disable the TAP controller, TCK must be tied LOW (V_{SS}) to prevent clocking of the device. TDI and TMS are internally pulled up and may be unconnected. They may alternately be connected to V_{DD} through a pull-up resistor. TDO should be left unconnected. Upon power-up, the device will come up in a reset state which will not interfere with the operation of the device.

The 0/1 next to each state represents the value of TMS at the rising edge of TCK.

Test Access Port (TAP)

Test Clock (TCK)

The test clock is used only with the TAP controller. All inputs are captured on the rising edge of TCK. All outputs are driven from the falling edge of TCK.

Test Mode Select (TMS)

The TMS input is used to give commands to the TAP controller and is sampled on the rising edge of TCK. It is allowable to leave this ball unconnected if the TAP is not used. The ball is pulled up internally, resulting in a logic HIGH level.

Test Data-In (TDI)

The TDI ball is used to serially input information into the registers and can be connected to the input of any of the registers. The register between TDI and TDO is chosen by the instruction that is loaded into the TAP instruction register. TDI is internally pulled up and can be unconnected if the TAP is unused in an application. TDI is connected to the most significant bit (MSB) of any register.

Test Data-Out (TDO)

The TDO output ball is used to serially clock data-out from the registers. The output is active depending upon the current state of the TAP state machine. The output changes on the falling edge of TCK. TDO is connected to the least significant bit (LSB) of any register.

Performing a TAP Reset

A Reset is performed by forcing TMS HIGH (V_{DD}) for five rising edges of TCK. This Reset does not affect the operation of the SRAM and may be performed while the SRAM is operating.

At power-up, the TAP is reset internally to ensure that TDO comes up in a High Z state.

TAP Registers

Registers are connected between the TDI and TDO balls and allow data to be scanned into and out of the SRAM test circuitry. Only one register can be selected at a time through the instruction register. Data is serially loaded into the TDI ball on the rising edge of TCK. Data is output on the TDO ball on the falling edge of TCK.

Instruction Register

Three-bit instructions can be serially loaded into the instruction register. This register is loaded when it is placed between the TDI and TDO balls as shown in the [TAP Controller Block Diagram on page 15](#). Upon power-up, the instruction register is loaded with the IDCODE instruction. It is also loaded with the IDCODE instruction if the controller is placed in a reset state as described in the previous section.

When the TAP controller is in the Capture-IR state, the two least significant bits are loaded with a binary "01" pattern to allow for fault isolation of the board-level serial test data path.

Bypass Register

To save time when serially shifting data through registers, it is sometimes advantageous to skip certain chips. The bypass register is a single-bit register that can be placed between the TDI and TDO balls. This allows data to be shifted through the SRAM with minimal delay. The bypass register is set LOW (V_{SS}) when the BYPASS instruction is executed.

Boundary Scan Register

The boundary scan register is connected to all the input and bidirectional balls on the SRAM.

The boundary scan register is loaded with the contents of the RAM I/O ring when the TAP controller is in the Capture-DR state and is then placed between the TDI and TDO balls when the controller is moved to the Shift-DR state. The EXTEST, SAMPLE/PRELOAD and SAMPLE Z instructions can be used to capture the contents of the I/O ring.

The Boundary Scan Order tables show the order in which the bits are connected. Each bit corresponds to one of the bumps on the SRAM package. The MSB of the register is connected to TDI and the LSB is connected to TDO.

Identification (ID) Register

The ID register is loaded with a vendor-specific, 32-bit code during the Capture-DR state when the IDCODE command is loaded in the instruction register. The IDCODE is hardwired into the SRAM and can be shifted out when the TAP controller is in the Shift-DR state. The ID register has a vendor code and other information described in the Identification Register Definitions table.

Note

17. Errata: The JTAG testing should be performed with these devices in BYPASS mode as the JTAG functionality is not guaranteed. For more information, see "Errata" on page 30.

TAP Instruction Set

Overview

Eight different instructions are possible with the three bit instruction register. All combinations are listed in the Instruction Codes table. Three of these instructions are listed as RESERVED and should not be used. The other five instructions are described in detail below.

Instructions are loaded into the TAP controller during the Shift-IR state when the instruction register is placed between TDI and TDO. During this state, instructions are shifted through the instruction register through the TDI and TDO balls. To execute the instruction once it is shifted in, the TAP controller needs to be moved into the Update-IR state.

EXTEST

The EXTEST instruction enables the preloaded data to be driven out through the system output pins. This instruction also selects the boundary scan register to be connected for serial access between the TDI and TDO in the shift-DR controller state.

IDCODE

The IDCODE instruction causes a vendor-specific, 32-bit code to be loaded into the instruction register. It also places the instruction register between the TDI and TDO balls and allows the IDCODE to be shifted out of the device when the TAP controller enters the Shift-DR state.

The IDCODE instruction is loaded into the instruction register upon power-up or whenever the TAP controller is given a test logic reset state.

SAMPLE Z

The SAMPLE Z instruction causes the boundary scan register to be connected between the TDI and TDO balls when the TAP controller is in a Shift-DR state. It also places all SRAM outputs into a High Z state.

SAMPLE/PRELOAD

SAMPLE/PRELOAD is a 1149.1-mandatory instruction. When the SAMPLE/PRELOAD instructions are loaded into the instruction register and the TAP controller is in the Capture-DR state, a snapshot of data on the inputs and output pins is captured in the boundary scan register.

The user must be aware that the TAP controller clock can only operate at a frequency up to 20 MHz, while the SRAM clock operates more than an order of magnitude faster. Because there is a large difference in the clock frequencies, it is possible that during the Capture-DR state, an input or output will undergo a transition. The TAP may then try to capture a signal while in transition (metastable state). This will not harm the device, but

there is no guarantee as to the value that will be captured. Repeatable results may not be possible.

To guarantee that the boundary scan register will capture the correct value of a signal, the SRAM signal must be stabilized long enough to meet the TAP controller's capture setup plus hold times (t_{CS} and t_{CH}). The SRAM clock input might not be captured correctly if there is no way in a design to stop (or slow) the clock during a SAMPLE/PRELOAD instruction. If this is an issue, it is still possible to capture all other signals and simply ignore the value of the CK and \overline{CK} captured in the boundary scan register.

Once the data is captured, it is possible to shift out the data by putting the TAP into the Shift-DR state. This places the boundary scan register between the TDI and TDO pins.

PRELOAD allows an initial data pattern to be placed at the latched parallel outputs of the boundary scan register cells prior to the selection of another boundary scan test operation.

The shifting of data for the SAMPLE and PRELOAD phases can occur concurrently when required – that is, while data captured is shifted out, the preloaded data can be shifted in.

BYPASS

When the BYPASS instruction is loaded in the instruction register and the TAP is placed in a Shift-DR state, the bypass register is placed between the TDI and TDO balls. The advantage of the BYPASS instruction is that it shortens the boundary scan path when multiple devices are connected together on a board.

EXTEST Output Bus Tristate

IEEE Standard 1149.1 mandates that the TAP controller be able to put the output bus into a tristate mode.

The boundary scan register has a special bit located at bit #85 (for 119-ball BGA package) or bit #89 (for 165-ball FBGA package). When this scan cell, called the "extest output bus tristate," is latched into the preload register during the "Update-DR" state in the TAP controller, it will directly control the state of the output (Q-bus) pins, when the EXTEST is entered as the current instruction. When HIGH, it will enable the output buffers to drive the output bus. When LOW, this bit will place the output bus into a High Z condition.

This bit can be set by entering the SAMPLE/PRELOAD or EXTEST command, and then shifting the desired bit into that cell, during the "Shift-DR" state. During "Update-DR," the value loaded into that shift-register cell will latch into the preload register. When the EXTEST instruction is entered, this bit will directly control the output Q-bus pins. Note that this bit is preset HIGH to enable the output when the device is powered-up, and also when the TAP controller is in the "Test-Logic-Reset" state.

Reserved

These instructions are not implemented but are reserved for future use. Do not use these instructions.

TAP Controller State Diagram

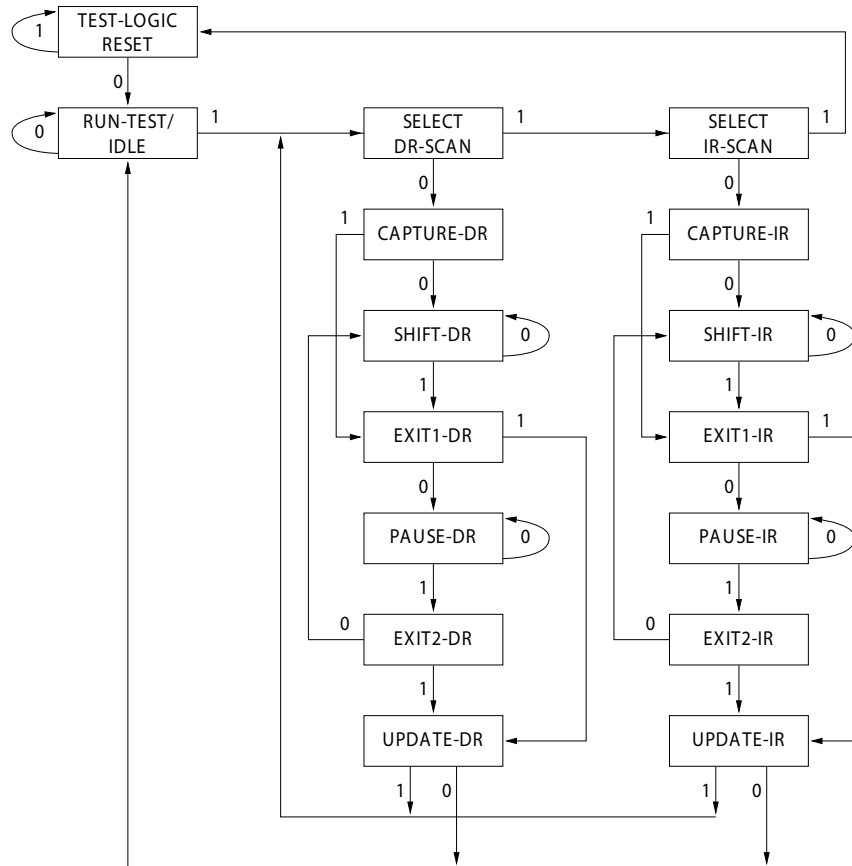

TAP Controller Block Diagram

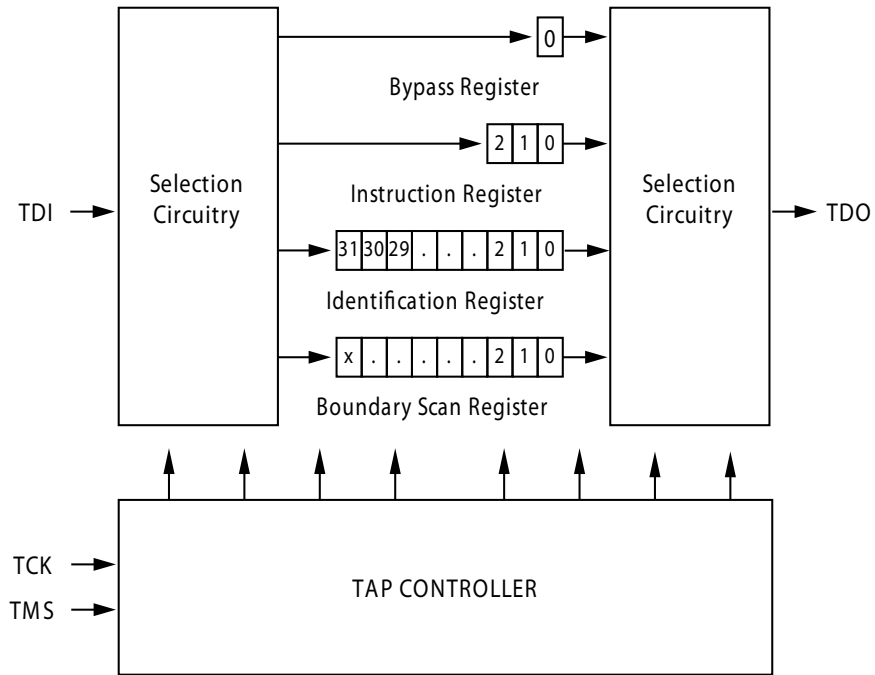

TAP Timing

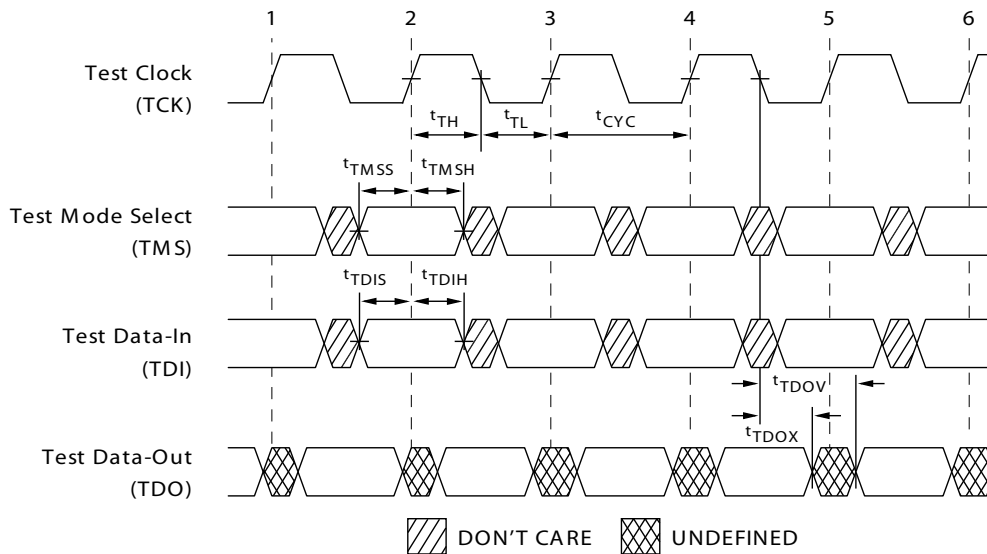

TAP AC Switching Characteristics

Over the Operating Range

Parameter ^[18, 19]	Description	Min	Max	Unit
Clock				
t_{TCYC}	TCK Clock Cycle Time	50	–	ns
t_{TF}	TCK Clock Frequency	–	20	MHz
t_{TH}	TCK Clock HIGH time	20	–	ns
t_{TL}	TCK Clock LOW time	20	–	ns
Output Times				
t_{TDOV}	TCK Clock LOW to TDO Valid	–	10	ns
t_{TDOX}	TCK Clock LOW to TDO Invalid	0	–	ns
Setup Times				
t_{TMSS}	TMS Setup to TCK Clock Rise	5	–	ns
t_{TDIS}	TDI Setup to TCK Clock Rise	5	–	ns
t_{CS}	Capture Setup to TCK Rise	5	–	ns
Hold Times				
t_{TMSH}	TMS Hold after TCK Clock Rise	5	–	ns
t_{TDIH}	TDI Hold after Clock Rise	5	–	ns
t_{CH}	Capture Hold after Clock Rise	5	–	ns

Notes

18. t_{CS} and t_{CH} refer to the setup and hold time requirements of latching data from the boundary scan register.
 19. Test conditions are specified using the load in TAP AC test Conditions. $t_R/t_F = 1$ ns.

3.3 V TAP AC Test Conditions

Input pulse levels V_{SS} to 3.3 V
 Input rise and fall times 1 ns
 Input timing reference levels 1.5 V
 Output reference levels 1.5 V
 Test load termination supply voltage 1.5 V

2.5 V TAP AC Test Conditions

Input pulse levels V_{SS} to 2.5 V
 Input rise and fall time 1 ns
 Input timing reference levels 1.25 V
 Output reference levels 1.25 V
 Test load termination supply voltage 1.25 V

3.3 V TAP AC Output Load Equivalent

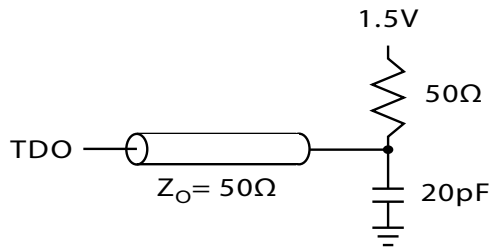

2.5 V TAP AC Output Load Equivalent

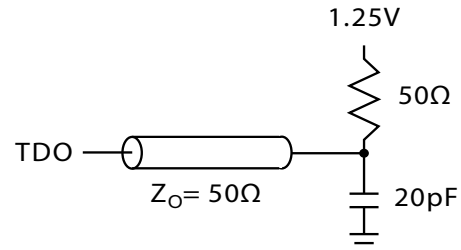

TAP DC Electrical Characteristics and Operating Conditions

(0 °C < T_A < +70 °C; V_{DD} = 3.3 V ± 0.165 V unless otherwise noted)

Parameter ^[20]	Description	Test Conditions	Min	Max	Unit	
V _{OH1}	Output HIGH Voltage	I _{OH} = -4.0 mA, V _{DDQ} = 3.3 V	2.4	-	V	
		I _{OH} = -1.0 mA, V _{DDQ} = 2.5 V	2.0	-	V	
V _{OH2}	Output HIGH Voltage	I _{OH} = -100 μA	V _{DDQ} = 3.3 V	2.9	-	V
			V _{DDQ} = 2.5 V	2.1	-	V
V _{OL1}	Output LOW Voltage	I _{OL} = 8.0 mA, V _{DDQ} = 3.3 V	-	0.4	V	
		I _{OL} = 8.0 mA, V _{DDQ} = 2.5 V	-	0.4	V	
V _{OL2}	Output LOW Voltage	I _{OL} = 100 μA	V _{DDQ} = 3.3 V	-	0.2	V
			V _{DDQ} = 2.5 V	-	0.2	V
V _{IH}	Input HIGH Voltage	V _{DDQ} = 3.3 V	2.0	V _{DD} + 0.3	V	
		V _{DDQ} = 2.5 V	1.7	V _{DD} + 0.3	V	
V _{IL}	Input LOW Voltage	V _{DDQ} = 3.3 V	-0.5	0.7	V	
		V _{DDQ} = 2.5 V	-0.3	0.7	V	
I _X	Input Load Current	GND ≤ V _{IN} ≤ V _{DDQ}	-5	5	μA	

Note

20. All voltages referenced to V_{SS} (GND)

Identification Register Definitions

Instruction Field	CY7C1370D	Description
Revision Number (31:29)	000	Reserved for version number.
Cypress Device ID (28:12) ^[21]	01011001000010101	Reserved for future use.
Cypress JEDEC ID (11:1)	00000110100	Allows unique identification of SRAM vendor.
ID Register Presence (0)	1	Indicate the presence of an ID register.

Scan Register Sizes

Register Name	Bit Size (× 36)
Instruction	3
Bypass	1
ID	32
Boundary Scan Order (165-ball FBGA package)	89

Identification Codes

Instruction	Code	Description
EXTEST	000	Captures I/O ring contents. Places the boundary scan register between TDI and TDO. Forces all SRAM outputs to High Z state.
IDCODE	001	Loads the ID register with the vendor ID code and places the register between TDI and TDO. This operation does not affect SRAM operations.
SAMPLE Z	010	Captures I/O ring contents. Places the boundary scan register between TDI and TDO. Forces all SRAM output drivers to a High Z state.
RESERVED	011	Do Not Use: This instruction is reserved for future use.
SAMPLE/PRELOAD	100	Captures I/O ring contents. Places the boundary scan register between TDI and TDO. Does not affect SRAM operation.
RESERVED	101	Do Not Use: This instruction is reserved for future use.
RESERVED	110	Do Not Use: This instruction is reserved for future use.
BYPASS	111	Places the bypass register between TDI and TDO. This operation does not affect SRAM operations.

Note

21. Bit #24 is "1" in the Register Definitions for both 2.5 V and 3.3 V versions of this device.

Boundary Scan Order

165-ball FBGA [22, 23]

Bit #	Ball ID
1	N6
2	N7
3	N10
4	P11
5	P8
6	R8
7	R9
8	P9
9	P10
10	R10
11	R11
12	H11
13	N11
14	M11
15	L11
16	K11
17	J11
18	M10
19	L10
20	K10
21	J10
22	H9
23	H10
24	G11
25	F11
26	E11
27	D11
28	G10
29	F10
30	E10

Bit #	Ball ID
31	D10
32	C11
33	A11
34	B11
35	A10
36	B10
37	A9
38	B9
39	C10
40	A8
41	B8
42	A7
43	B7
44	B6
45	A6
46	B5
47	A5
48	A4
49	B4
50	B3
51	A3
52	A2
53	B2
54	C2
55	B1
56	A1
57	C1
58	D1
59	E1
60	F1

Bit #	Ball ID
61	G1
62	D2
63	E2
64	F2
65	G2
66	H1
67	H3
68	J1
69	K1
70	L1
71	M1
72	J2
73	K2
74	L2
75	M2
76	N1
77	N2
78	P1
79	R1
80	R2
81	P3
82	R3
83	P2
84	R4
85	P4
86	N5
87	P6
88	R6
89	Internal

Notes

- 22. Balls which are NC (No Connect) are pre-set LOW.
- 23. Bit# 89 is preset HIGH.

Maximum Ratings

Exceeding maximum ratings may impair the useful life of the device. These user guidelines are not tested.

Storage Temperature -65 °C to +150 °C
 Ambient Temperature with
 Power Applied -55 °C to +125 °C
 Supply Voltage on V_{DD} Relative to GND -0.5 V to +4.6 V
 Supply Voltage on V_{DDQ} Relative to GND -0.5 V to +V_{DD}
 DC to Outputs in Tristate -0.5 V to V_{DDQ} + 0.5 V
 DC Input Voltage -0.5 V to V_{DD} + 0.5 V
 Current into Outputs (LOW) 20 mA
 Static Discharge Voltage
 (per MIL-STD-883, Method 3015) > 2001V
 Latch up Current > 200 mA

Operating Range

Range	Ambient Temperature	V _{DD}	V _{DDQ}
Commercial	0 °C to +70 °C	3.3 V – 5% / +10%	2.5 V – 5% to V _{DD}
Industrial	-40 °C to +85 °C		

Neutron Soft Error Immunity

Parameter	Description	Test Conditions	Typ	Max*	Unit
LSBU	Logical Single-Bit Upsets	25 °C	361	394	FIT/Mb
LMBU	Logical Multi-Bit Upsets	25 °C	0	0.01	FIT/Mb
SEL	Single Event Latch up	85 °C	0	0.1	FIT/Dev

* No LMBU or SEL events occurred during testing; this column represents a statistical χ^2 , 95% confidence limit calculation. For more details refer to Application Note AN54908 "Accelerated Neutron SER Testing and Calculation of Terrestrial Failure Rates".

Electrical Characteristics

Over the Operating Range

Parameter ^[24, 25]	Description	Test Conditions	Min	Max	Unit
V _{DD}	Power Supply Voltage		3.135	3.6	V
V _{DDQ}	I/O Supply Voltage	for 3.3 V I/O	3.135	V _{DD}	V
		for 2.5 V I/O	2.375	2.625	V
V _{OH}	Output HIGH Voltage	for 3.3 V I/O, I _{OH} = -4.0 mA	2.4	-	V
		for 2.5 V I/O, I _{OH} = -1.0 mA	2.0	-	V
V _{OL}	Output LOW Voltage	for 3.3 V I/O, I _{OL} = 8.0 mA	-	0.4	V
		for 2.5 V I/O, I _{OL} = 1.0 mA	-	0.4	V
V _{IH}	Input HIGH Voltage ^[24]	for 3.3 V I/O	2.0	V _{DD} + 0.3 V	V
		for 2.5 V I/O	1.7	V _{DD} + 0.3 V	V
V _{IL}	Input LOW Voltage ^[24]	for 3.3 V I/O	-0.3	0.8	V
		for 2.5 V I/O	-0.3	0.7	V
I _X	Input Leakage Current except ZZ and MODE	GND ≤ V _I ≤ V _{DDQ}	-5	5	μA
		Input = V _{SS}	-30	-	μA
	Input Current of MODE	Input = V _{DD}	-	5	μA
		Input = V _{SS}	-5	-	μA
Input Current of ZZ	Input = V _{DD}	-	30	μA	
	Input = V _{SS}	-5	-	μA	
I _{OZ}	Output Leakage Current	GND ≤ V _I ≤ V _{DDQ} , Output Disabled	-5	5	μA

Notes

24. Overshoot: V_{IH(AC)} < V_{DD} + 1.5 V (Pulse width less than t_{CYC/2}), undershoot: V_{IL(AC)} > -2 V (Pulse width less than t_{CYC/2}).
 25. T_{Power-up}: Assumes a linear ramp from 0 V to V_{DD(min.)} within 200 ms. During this time V_{IH} < V_{DD} and V_{DDQ} ≤ V_{DD}.

Electrical Characteristics (continued)

Over the Operating Range

Parameter ^[24, 25]	Description	Test Conditions	Min	Max	Unit	
I _{DD}	V _{DD} Operating Supply	V _{DD} = Max., I _{OUT} = 0 mA, f = f _{MAX} = 1/t _{CYC}	4-ns cycle, 250 MHz	–	350	mA
			5-ns cycle, 200 MHz	–	300	mA
			6-ns cycle, 167 MHz	–	275	mA
I _{SB1}	Automatic CE Power-down Current – TTL Inputs	Max. V _{DD} , Device Deselected, V _{IN} ≥ V _{IH} or V _{IN} ≤ V _{IL} , f = f _{MAX} = 1/t _{CYC}	4-ns cycle, 250 MHz	–	160	mA
			5-ns cycle, 200 MHz	–	150	mA
			6-ns cycle, 167 MHz	–	140	mA
I _{SB2}	Automatic CE Power-down Current – CMOS Inputs	Max. V _{DD} , Device Deselected, V _{IN} ≤ 0.3 V or V _{IN} ≥ V _{DDQ} – 0.3 V, f = 0	All speed grades	–	70	mA
I _{SB3}	Automatic CE Power-down Current – CMOS Inputs	Max. V _{DD} , Device Deselected, V _{IN} ≤ 0.3 V or V _{IN} ≥ V _{DDQ} – 0.3 V, f = f _{MAX} = 1/t _{CYC}	4-ns cycle, 250 MHz	–	135	mA
			5-ns cycle, 200 MHz	–	130	mA
			6-ns cycle, 167 MHz	–	125	mA
I _{SB4}	Automatic CE Power-down Current – TTL Inputs	Max. V _{DD} , Device Deselected, V _{IN} ≥ V _{IH} or V _{IN} ≤ V _{IL} , f = 0	All speed grades	–	80	mA

Capacitance

Parameter ^[26]	Description	Test Conditions	100-pin TQFP Max	165-ball FBGA Max	Unit
C _{IN}	Input capacitance	T _A = 25 °C, f = 1 MHz, V _{DD} = 3.3 V, V _{DDQ} = 2.5 V	5	9	pF
C _{CLK}	Clock input capacitance		5	9	pF
C _{I/O}	Input/Output capacitance		5	9	pF

Thermal Resistance

Parameter ^[26]	Description	Test Conditions	100-pin TQFP Package	165-ball FBGA Package	Unit
θ _{JA}	Thermal resistance (junction to ambient)	Test conditions follow standard test methods and procedures for measuring thermal impedance, per EIA/JESD51.	28.66	20.7	°C/W
θ _{JC}	Thermal resistance (junction to case)		4.08	4.0	°C/W

Note

26. Tested initially and after any design or process change that may affect these parameters.

AC Test Loads and Waveforms

Figure 3. AC Test Loads and Waveforms

3.3V I/O Test Load

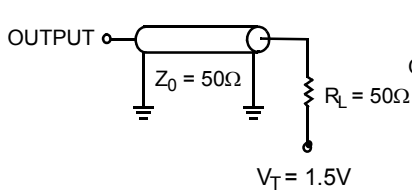

(a)

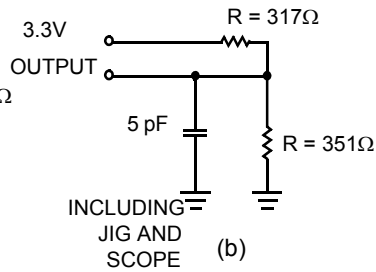

(b)

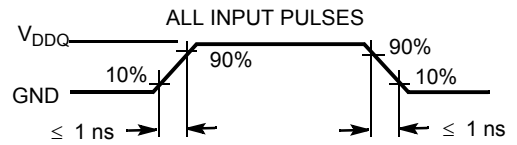

(c)

2.5V I/O Test Load

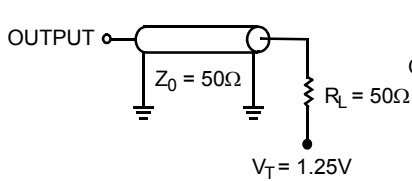

(a)

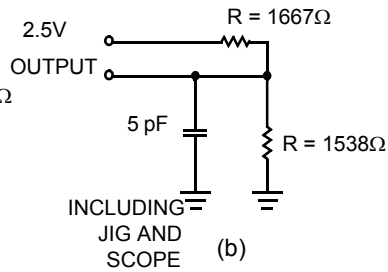

(b)

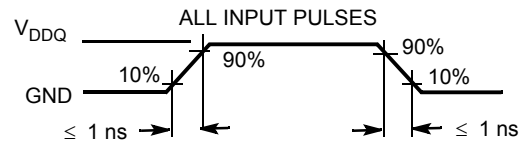

(c)

Switching Characteristics

Over the Operating Range

Parameter [27, 28]	Description	-250		-200		-167		Unit
		Min	Max	Min	Max	Min	Max	
$t_{Power}^{[29]}$	V_{CC} (typical) to the first access read or write	1	–	1	–	1	–	ms
Clock								
t_{CYC}	Clock cycle time	4.0	–	5	–	6	–	ns
F_{MAX}	Maximum operating frequency	–	250	–	200	–	167	MHz
t_{CH}	Clock HIGH	1.7	–	2.0	–	2.2	–	ns
t_{CL}	Clock LOW	1.7	–	2.0	–	2.2	–	ns
Output Times								
t_{CO}	Data output valid after CLK rise	–	2.6	–	3.0	–	3.4	ns
t_{EOV}	\overline{OE} LOW to output valid	–	2.6	–	3.0	–	3.4	ns
t_{DOH}	Data output hold after CLK rise	1.0	–	1.3	–	1.3	–	ns
t_{CHZ}	Clock to high Z [30, 31, 32]	–	2.6	–	3.0	–	3.4	ns
t_{CLZ}	Clock to low Z [30, 31, 32]	1.0	–	1.3	–	1.3	–	ns
t_{EOHZ}	\overline{OE} HIGH to output high Z [30, 31, 32]	–	2.6	–	3.0	–	3.4	ns
t_{EOLZ}	\overline{OE} LOW to output low Z [30, 31, 32]	0	–	0	–	0	–	ns
Setup Times								
t_{AS}	Address setup before CLK rise	1.2	–	1.4	–	1.5	–	ns
t_{DS}	Data input setup before CLK rise	1.2	–	1.4	–	1.5	–	ns
t_{CENS}	\overline{CEN} setup before CLK rise	1.2	–	1.4	–	1.5	–	ns
t_{WES}	\overline{WE} , \overline{BW}_x setup before CLK rise	1.2	–	1.4	–	1.5	–	ns
t_{ALS}	ADV/LD setup before CLK rise	1.2	–	1.4	–	1.5	–	ns
t_{CES}	Chip select setup	1.2	–	1.4	–	1.5	–	ns
Hold Times								
t_{AH}	Address hold after CLK rise	0.3	–	0.4	–	0.5	–	ns
t_{DH}	Data input hold after CLK rise	0.3	–	0.4	–	0.5	–	ns
t_{CENH}	\overline{CEN} hold after CLK rise	0.3	–	0.4	–	0.5	–	ns
t_{WEH}	\overline{WE} , \overline{BW}_x hold after CLK rise	0.3	–	0.4	–	0.5	–	ns
t_{ALH}	ADV/LD hold after CLK rise	0.3	–	0.4	–	0.5	–	ns
t_{CEH}	Chip select hold after CLK rise	0.3	–	0.4	–	0.5	–	ns

Notes

27. Timing reference is 1.5 V when $V_{DDQ} = 3.3$ V and is 1.25 V when $V_{DDQ} = 2.5$ V.

28. Test conditions shown in (a) of Figure 3 on page 22 unless otherwise noted.

29. This part has a voltage regulator internally; t_{Power} is the time power needs to be supplied above V_{DD} minimum initially, before a Read or Write operation can be initiated.

30. t_{CHZ} , t_{CLZ} , t_{EOLZ} , and t_{EOHZ} are specified with AC test conditions shown in (b) of Figure 3 on page 22. Transition is measured ± 200 mV from steady-state voltage.

31. At any given voltage and temperature, t_{EOHZ} is less than t_{EOLZ} and t_{CHZ} is less than t_{CLZ} to eliminate bus contention between SRAMs when sharing the same data bus. These specifications do not imply a bus contention condition, but reflect parameters guaranteed over worst case user conditions. Device is designed to achieve High Z prior to Low Z under the same system conditions.

32. This parameter is sampled and not 100% tested.

Switching Waveforms

Figure 4. Read/Write/Timing [33, 34, 35]

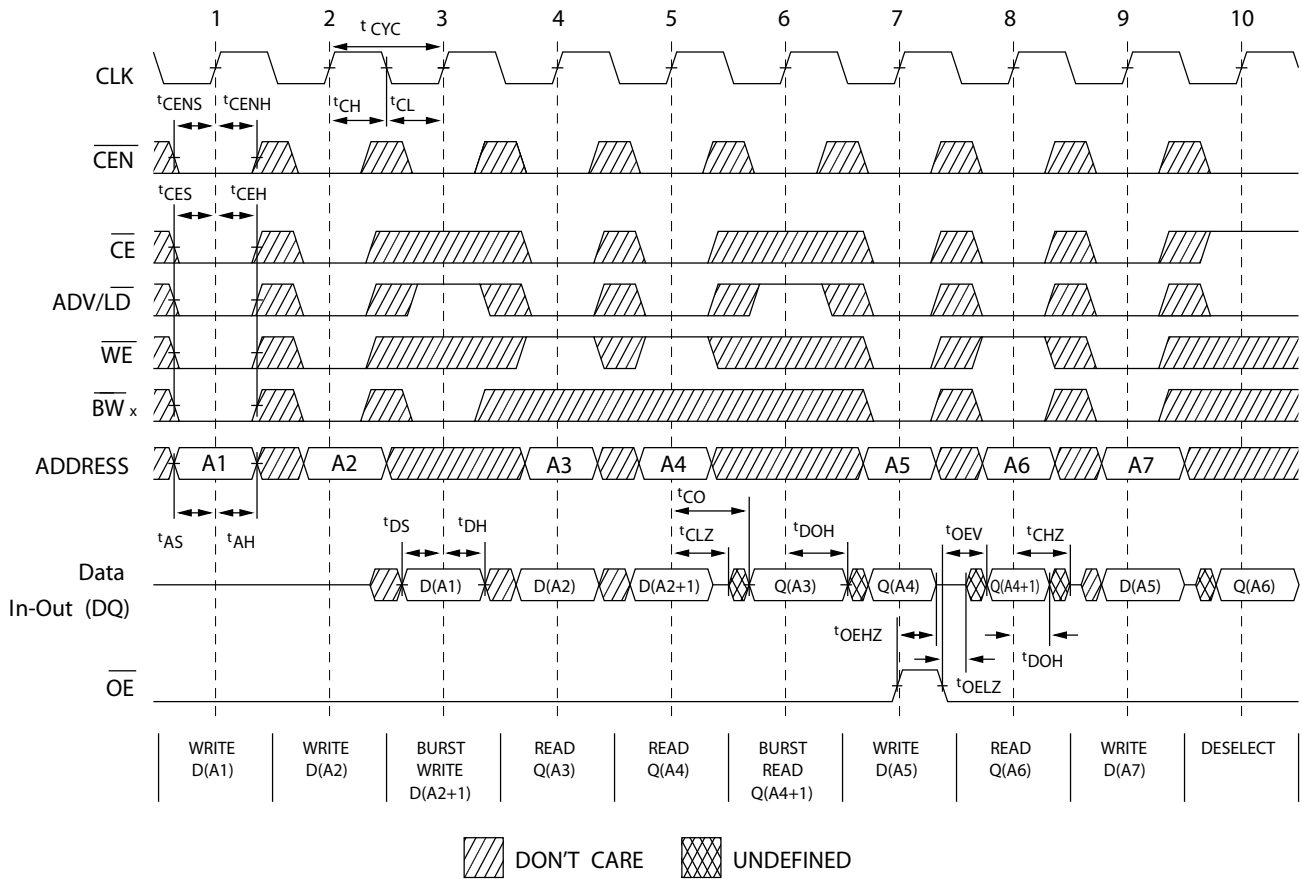

Notes

33. For this waveform ZZ is tied LOW.

34. When \overline{CE} is LOW, \overline{CE}_1 is LOW, \overline{CE}_2 is HIGH and \overline{CE}_3 is LOW. When \overline{CE} is HIGH, \overline{CE}_1 is HIGH or \overline{CE}_2 is LOW or \overline{CE}_3 is HIGH.

35. Order of the Burst sequence is determined by the status of the MODE (0 = Linear, 1 = Interleaved). Burst operations are optional.

Switching Waveforms (continued)

Figure 5. NOP, STALL, and DESELECT Cycles [36, 37, 38]

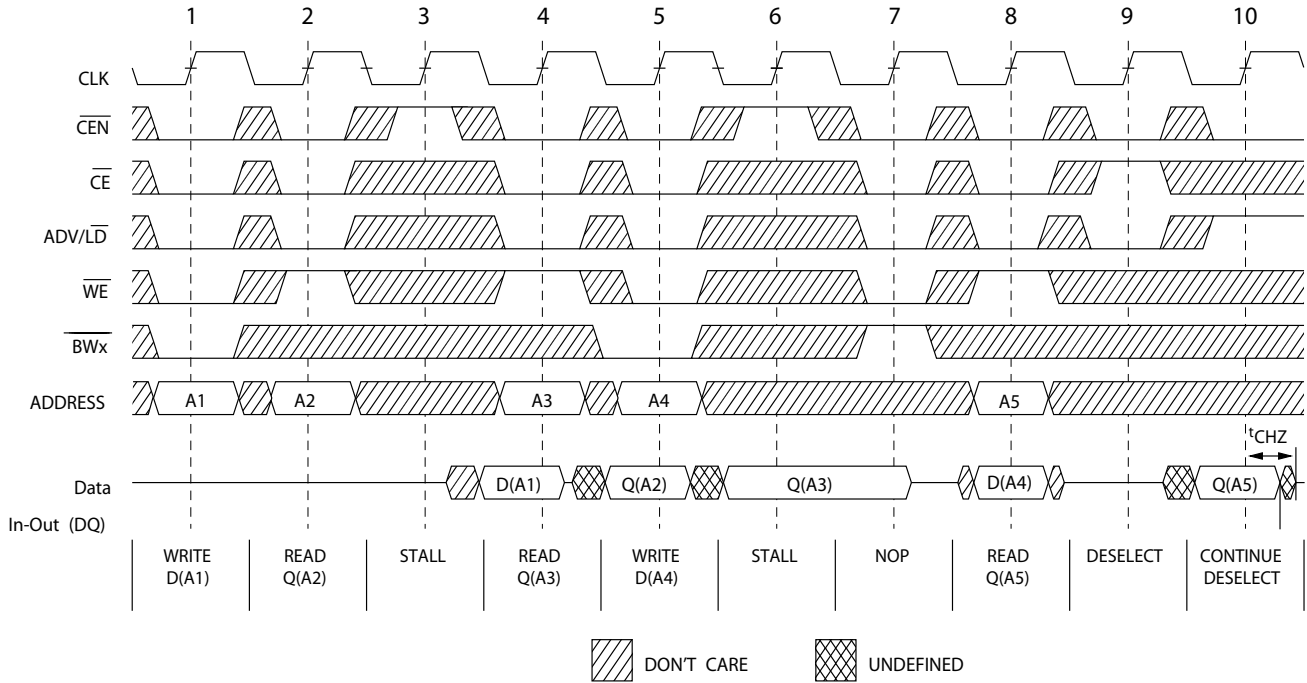
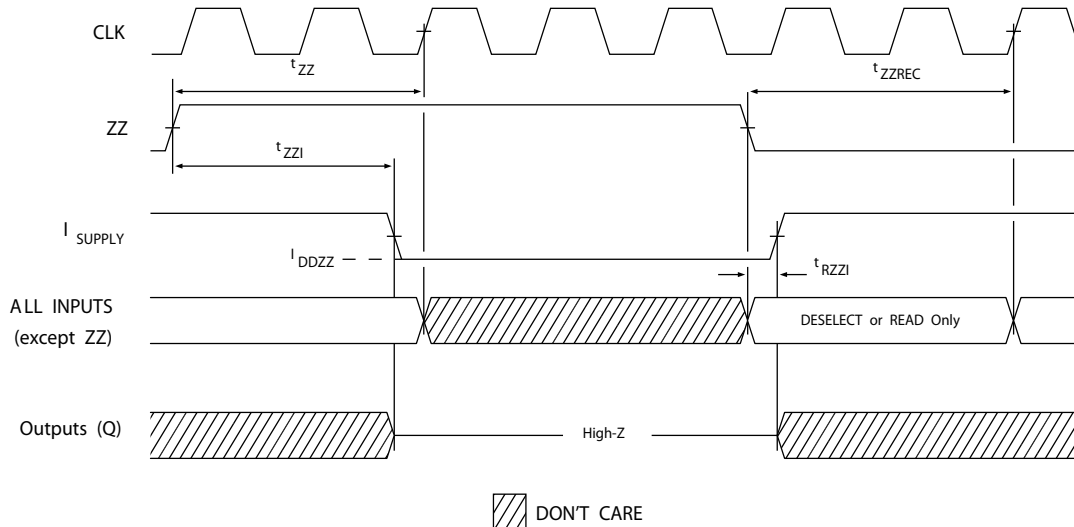

Figure 6. ZZ Mode Timing [39, 40]



Notes

- 36. For this waveform ZZ is tied LOW.
- 37. When \overline{CE} is LOW, \overline{CE}_1 is LOW, CE_2 is HIGH and \overline{CE}_3 is LOW. When \overline{CE} is HIGH, \overline{CE}_1 is HIGH or CE_2 is LOW or \overline{CE}_3 is HIGH.
- 38. The Ignore Clock Edge or Stall cycle (Clock 3) illustrated CEN being used to create a pause. A write is not performed during this cycle.
- 39. Device must be deselected when entering ZZ mode. See cycle description table for all possible signal conditions to deselect the device.
- 40. I/Os are in High Z when exiting ZZ sleep mode.

Ordering Information

Cypress offers other versions of this type of product in many different configurations and features. The following table contains only the list of parts that are currently available.

For a complete listing of all options, visit the Cypress website at www.cypress.com and refer to the product summary page at <http://www.cypress.com/products> or contact your local sales representative.

Cypress maintains a worldwide network of offices, solution centers, manufacturer's representatives and distributors. To find the office closest to you, visit us at <http://www.cypress.com/go/datasheet/offices>.

Speed (MHz)	Ordering Code	Package Diagram	Part and Package Type	Operating Range
167	CY7C1370D-167AXC	51-85050	100-pin TQFP (14 × 20 × 1.4 mm) Pb-free	Commercial
	CY7C1372D-167AXC			
	CY7C1370D-167BZXC	51-85180	165-ball FBGA (13 × 15 × 1.4 mm) Pb-free	Industrial
	CY7C1370D-167AXI	51-85050	100-pin TQFP (14 × 20 × 1.4 mm) Pb-free	
	CY7C1372D-167AXI			
200	CY7C1370D-200AXC	51-85050	100-pin TQFP (14 × 20 × 1.4 mm) Pb-free	Commercial
	CY7C1372D-200AXC			
	CY7C1370D-200BZI	51-85180	165-ball FBGA (13 × 15 × 1.4 mm)	Industrial
	CY7C1370D-200AXI	51-85050	100-pin TQFP (14 × 20 × 1.4 mm) Pb-free	
250	CY7C1370D-250AXC	51-85050	100-pin TQFP (14 × 20 × 1.4 mm) Pb-free	Commercial
	CY7C1370D-250AXI			Industrial

Ordering Code Definitions

CY 7 C 13XX D - XXX XX X X

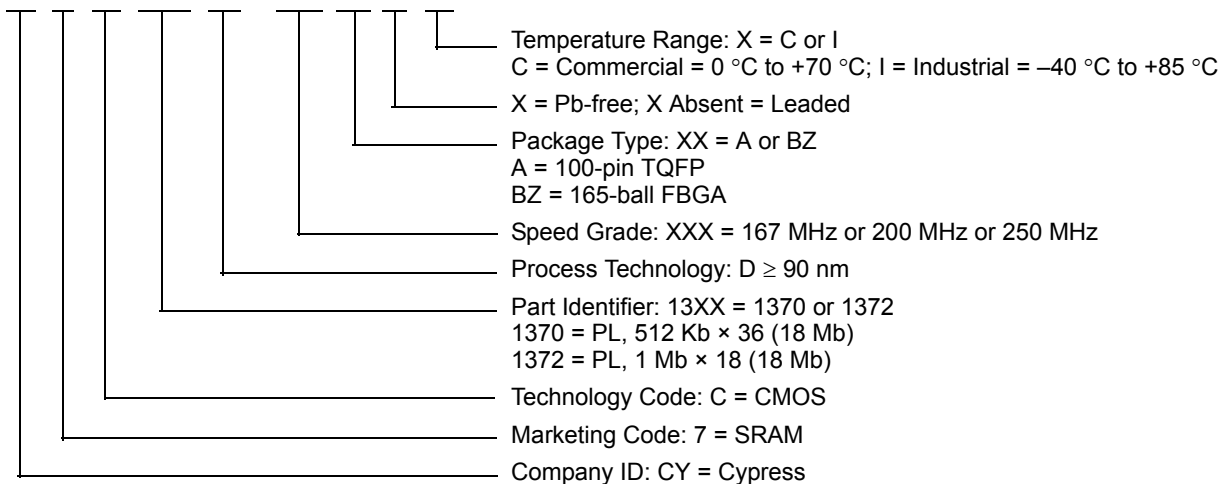

Package Diagrams

Figure 7. 100-pin TQFP (14 × 20 × 1.4 mm) A100RA Package Outline, 51-85050

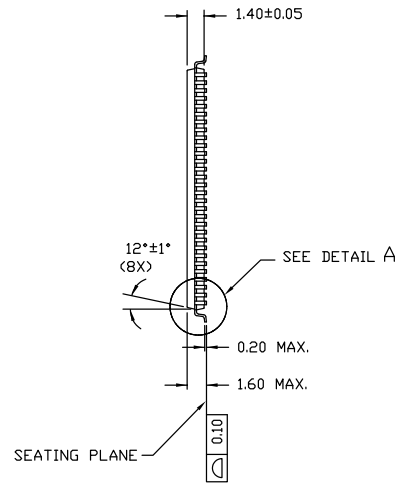
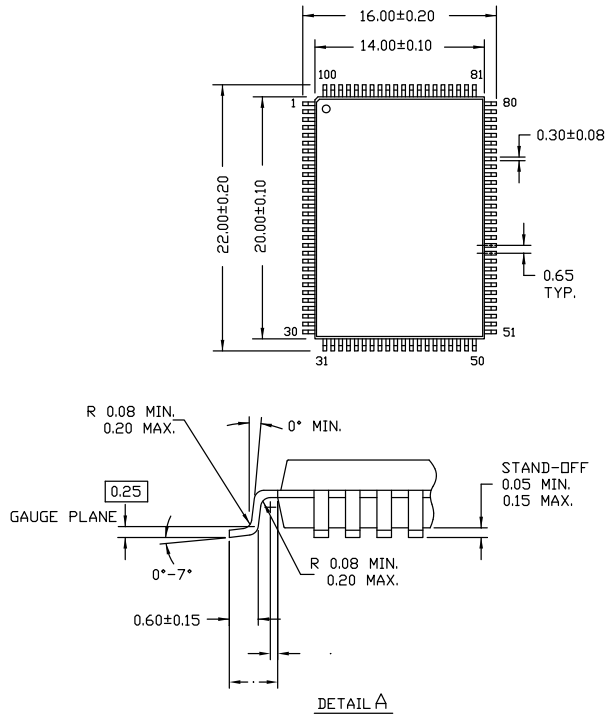

NOTE:

1. JEDEC STD REF MS-026
2. BODY LENGTH DIMENSION DOES NOT INCLUDE MOLD PROTRUSION/END FLASH
MOLD PROTRUSION/END FLASH SHALL NOT EXCEED 0.0098 in (0.25 mm) PER SIDE
BODY LENGTH DIMENSIONS ARE MAX PLASTIC BODY SIZE INCLUDING MOLD MISMATCH
3. DIMENSIONS IN MILLIMETERS

51-85050 *E

Package Diagrams (continued)

Figure 8. 165-ball FBGA (13 × 15 × 1.4 mm) BB165D/BW165D (0.5 Ball Diameter) Package Outline, 51-85180

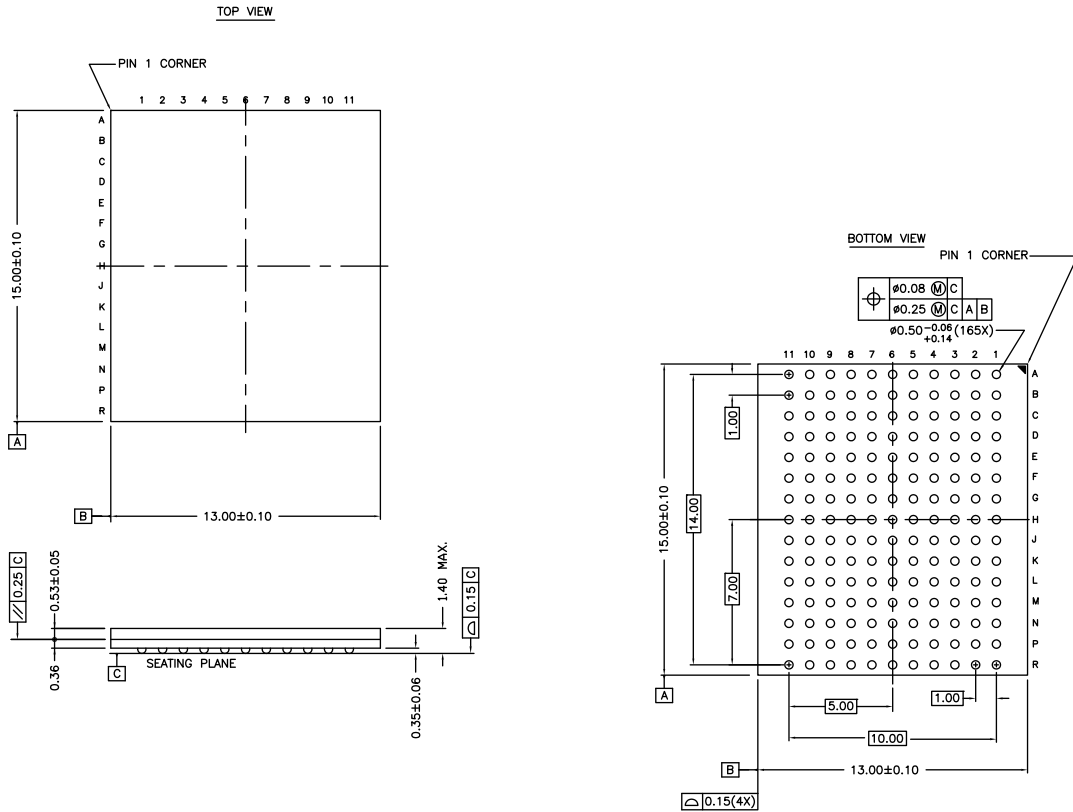

NOTES :
 SOLDER PAD TYPE : NON-SOLDER MASK DEFINED (NSMD)
 JEDEC REFERENCE : MO-216 / ISSUE E
 PACKAGE CODE : BB0AC/BW0AC
 PACKAGE WEIGHT : SEE CYPRESS PACKAGE MATERIAL DECLARATION
 DATASHEET (PMDD) POSTED ON THE CYPRESS WEB.

51-85180 *F

Acronyms

Acronym	Description
CE	Chip Enable
$\overline{\text{CEN}}$	Clock Enable
CMOS	Complementary Metal Oxide Semiconductor
FBGA	Fine-Pitch Ball Grid Array
I/O	Input/Output
JTAG	Joint Test Action Group
LMBU	Logical Multi-Bit Upsets
LSB	Least Significant Bit
LSBU	Logical Single-Bit Upsets
MSB	Most Significant Bit
NoBL	No Bus Latency
$\overline{\text{OE}}$	Output Enable
SEL	Single Event Latch-up
SRAM	Static Random Access Memory
TAP	Test Access Port
TCK	Test Clock
TMS	Test Mode Select
TDI	Test Data-In
TDO	Test Data-Out
TQFP	Thin Quad Flat Pack
TTL	Transistor-Transistor Logic
$\overline{\text{WE}}$	Write Enable

Document Conventions

Units of Measure

Symbol	Unit of Measure
°C	degree Celsius
k Ω	kilohm
MHz	megahertz
μA	microampere
μs	microsecond
mA	milliampere
mV	millivolt
mm	millimeter
ms	millisecond
ns	nanosecond
Ω	ohm
%	percent
pF	picofarad
ps	picosecond
V	volt
W	watt

Errata

This section describes the Ram9 NoBL ZZ pin and JTAG issues. Details include trigger conditions, the devices affected, proposed workaround and silicon revision applicability. Please contact your local Cypress sales representative if you have further questions.

Part Numbers Affected

Density & Revision	Package Type	Operating Range
18Mb-Ram9 NoBL SRAMs: CY7C137*D	100-pin TQFP	Commercial/ Industrial
	165-ball FBGA	

Product Status

All of the devices in the Ram9 18Mb NoBL family are qualified and available in production quantities.

Ram9 NoBL ZZ Pin & JTAG Issues Errata Summary

The following table defines the errata applicable to available Ram9 18Mb NoBL family devices.

Item	Issues	Description	Device	Fix Status
1.	ZZ Pin	When asserted HIGH, the ZZ pin places device in a "sleep" condition with data integrity preserved. The ZZ pin currently does not have an internal pull-down resistor and hence cannot be left floating externally by the user during normal mode of operation.	18M-Ram9 (90nm)	For the 18M Ram9 (90 nm) devices, there is no plan to fix this issue.
2.	JTAG Functionality	During JTAG test mode, the Boundary scan circuitry does not perform as described in the datasheet. However, it is possible to perform the JTAG test with these devices in "BYPASS mode".	18M-Ram9 (90nm)	This issue will be fixed in the new revision, which use the 65 nm technology. Please contact your local sales rep for availability.

1. ZZ Pin Issue

■ PROBLEM DEFINITION

The problem occurs only when the device is operated in the normal mode with ZZ pin left floating. The ZZ pin on the SRAM device does not have an internal pull-down resistor. Switching noise in the system may cause the SRAM to recognize a HIGH on the ZZ input, which may cause the SRAM to enter sleep mode. This could result in incorrect or undesirable operation of the SRAM.

■ TRIGGER CONDITIONS

Device operated with ZZ pin left floating.

■ SCOPE OF IMPACT

When the ZZ pin is left floating, the device delivers incorrect data.

■ WORKAROUND

Tie the ZZ pin externally to ground.

■ FIX STATUS

For the 18M Ram9 (90 nm) devices, there is no plan to fix this issue.

2. JTAG Functionality

■ PROBLEM DEFINITION

The problem occurs only when the device is operated in the JTAG test mode. During this mode, the JTAG circuitry can perform incorrectly by delivering the incorrect data or the incorrect scan chain length.

■ TRIGGER CONDITIONS

Several conditions can trigger this failure mode.

1. The device can deliver an incorrect length scan chain when operating in JTAG mode.
2. Some Byte Write inputs only recognize a logic HIGH level when in JTAG mode.
3. Incorrect JTAG data can be read from the device when the ZZ input is tied HIGH during JTAG operation.

■ SCOPE OF IMPACT

The device fails for JTAG test. This does not impact the normal functionality of the device.

■ WORKAROUND

1. Perform JTAG testing with these devices in "BYPASS mode".
2. Do not use JTAG test.

■ FIX STATUS

This issue will be fixed in the new revision, which use the 65 nm technology. Please contact your local sales rep for availability

Document History Page

Document Title: CY7C1370D/CY7C1372D, 18-Mbit (512 K × 36/1 M × 18) Pipelined SRAM with NoBL™ Architecture Document Number: 38-05555				
Rev.	ECN No.	Orig. of Change	Submission Date	Description of Change
**	254509	RKF	See ECN	New data sheet.
*A	276690	VBL	See ECN	Updated Ordering Information (Changed TQFP package to Lead-free TQFP package in Ordering Information section, added comment of Lead-free BG and BZ packages availability).
*B	288531	SYT	See ECN	Updated IEEE 1149.1 Serial Boundary Scan (JTAG [17]) (Edited description for non-compliance with 1149.1). Updated Ordering Information (Added lead-free information for 100-pin TQFP, 119-ball BGA and 165-ball FBGA Packages).
*C	326078	PCI	See ECN	Changed status from Preliminary to Final. Updated Selection Guide (Removed shading). Updated Pin Configurations (Address expansion pins/balls in the pinouts for all packages are modified as per JEDEC standard). Updated IEEE 1149.1 Serial Boundary Scan (JTAG [17]) (Updated TAP Instruction Set (Updated OVERVIEW (Updated description), updated EXTEST (Updated description), added EXTEST Output Bus Tristate)). Updated Electrical Characteristics (Removed shading, updated Test Conditions of V_{OL} , V_{OH} parameters). Updated Thermal Resistance (Changed values of θ_{JA} and θ_{JC} parameters for 100-pin TQFP Package from 31 °C/W and 6 °C/W to 28.66 °C/W and 4.08 °C/W respectively, changed values of θ_{JA} and θ_{JC} parameters for 119-ball BGA Package from 45 °C/W and 7 °C/W to 23.8 °C/W and 6.2 °C/W respectively, changed values of θ_{JA} and θ_{JC} parameters for 165-ball FBGA Package from 46 °C/W and 3 °C/W to 20.7 °C/W and 4.0 °C/W respectively). Updated Switching Characteristics (Removed shading). Updated Ordering Information (Updated part numbers, removed comment of "Lead-free BG packages availability" below the Ordering Information).
*D	370734	PCI	See ECN	Updated Electrical Characteristics (Updated Note 25 (Modified test condition from $V_{DDQ} < V_{DD}$ to $V_{DDQ} \leq V_{DD}$)).
*E	416321	NXR	See ECN	Changed address of Cypress Semiconductor Corporation from "3901 North First Street" to "198 Champion Court" Updated Electrical Characteristics (Updated Note 25 (Modified test condition from $V_{IH} \leq V_{DD}$ to $V_{IH} < V_{DD}$, changed "Input Load Current except ZZ and MODE" to "Input Leakage Current except ZZ and MODE", changed maximum value of I_X parameter corresponding to Input Current of MODE (Input = V_{SS}) from -5 µA to -30 µA, changed minimum value of I_X parameter corresponding to Input Current of MODE (Input = V_{DD}) from 30 µA to 5 µA, changed maximum value of I_X parameter corresponding to Input Current of ZZ (Input = V_{SS}) from -30 µA to -5 µA, changed minimum value of I_X parameter corresponding to Input Current of ZZ (Input = V_{DD}) from 5 µA to 30 µA). Updated Ordering Information (Updated part numbers, replaced Package Name column with Package Diagram in the Ordering Information table). Replaced three-state with tri-state in all instances across the document.
*F	475677	VKN	See ECN	Updated TAP AC Switching Characteristics Changed minimum value of t_{TH} , t_{TL} parameters from 25 ns to 20 ns, changed maximum value of t_{DOV} parameter from 5 ns to 10 ns). Updated Maximum Ratings (Added the Maximum Rating for Supply Voltage on V_{DDQ} Relative to GND). Updated Ordering Information (Updated part numbers).
*G	2756940	VKN	08/27/2009	Added Neutron Soft Error Immunity . Updated Ordering Information (By including parts that are available, and modified the disclaimer for the Ordering information).

Document History Page (continued)

Document Title: CY7C1370D/CY7C1372D, 18-Mbit (512 K × 36/1 M × 18) Pipelined SRAM with NoBL™ Architecture Document Number: 38-05555				
Rev.	ECN No.	Orig. of Change	Submission Date	Description of Change
*H	2896585	NJY	03/21/2010	Updated Ordering Information (Removed obsolete parts from Ordering Information table). Updated Package Diagrams . Updated Sales, Solutions, and Legal Information section. Updated in new template.
*I	2906603	NJY	04/07/2010	Updated Ordering Information (Removed inactive part from Ordering Information table).
*J	3055192	NJY	10/11/2010	Updated Ordering Information (Updated part numbers) and added Ordering Code Definitions .
*K	3067198	NJY	10/20/2010	Updated Ordering Information (Updated part numbers).
*L	3306791	OSN	07/08/2011	Updated Package Diagrams . Added Acronyms and Units of Measure . Updated in new template.
*M	3618004	PRIT	05/15/2012	Updated Features (Removed 119-ball BGA package related information). Updated Pin Configurations (Removed 119-ball BGA package related information, updated Figure 2 (Removed CY7C1372D related information)). Updated IEEE 1149.1 Serial Boundary Scan (JTAG [17]) (Removed CY7C1372D related information). Updated Identification Register Definitions (Removed CY7C1372D related information). Updated Scan Register Sizes (Removed “Bit Size (× 18)” column, removed 119-ball BGA package related information). Removed Boundary Scan Order (Corresponding to 119-ball BGA package). Updated Capacitance (Removed 119-ball BGA package related information). Updated Thermal Resistance (Removed 119-ball BGA package related information). Updated Ordering Information (Updated part numbers). Updated Package Diagrams (Removed 119-ball BGA package related information (spec 51-85115), spec 51-85180 (changed revision from *C to *E)).
*N	3666992	PRIT	07/05/2012	No technical updates. Completing Sunset review.
*O	3981545	PRIT	05/02/2013	Updated Package Diagrams : spec 51-85180 – Changed revision from *E to *F. Added Errata .
*P	4070421	PRIT	07/20/2013	Added Errata footnotes (Note 1, 2, 3, 4, 5, 17). Updated Pin Configurations : Added Note 1 and referred the same note in Figure 1 . Added Note 2, 3 and referred the same note in Figure 2 . Updated Pin Definitions : Added Note 4 and referred the same note in ZZ pin. Added Note 5 and referred the same note in TDO, TDI, TMS, TCK pins. Updated IEEE 1149.1 Serial Boundary Scan (JTAG [17]) : Added Note 17 and referred the same note in JTAG in the heading. Updated in new template. Completing Sunset Review.
*Q	4151890	PRIT	10/09/2013	Updated Errata .

Document History Page (continued)

Document Title: CY7C1370D/CY7C1372D, 18-Mbit (512 K × 36/1 M × 18) Pipelined SRAM with NoBL™ Architecture Document Number: 38-05555				
Rev.	ECN No.	Orig. of Change	Submission Date	Description of Change
*R	4491666	DEVM	09/03/2014	Updated Package Diagrams : spec 51-85050 – Changed revision from *D to *E. Completing Sunset Review.
*S	4571917	DEVM	11/18/2014	Added related documentation hyperlink in page 1. Removed pruned part CY7C1370D-200BZC.

Sales, Solutions, and Legal Information

Worldwide Sales and Design Support

Cypress maintains a worldwide network of offices, solution centers, manufacturer's representatives, and distributors. To find the office closest to you, visit us at [Cypress Locations](#).

Products

Automotive	cypress.com/go/automotive
Clocks & Buffers	cypress.com/go/clocks
Interface	cypress.com/go/interface
Lighting & Power Control	cypress.com/go/powerpsoc cypress.com/go/plc
Memory	cypress.com/go/memory
PSoC	cypress.com/go/psoc
Touch Sensing	cypress.com/go/touch
USB Controllers	cypress.com/go/USB
Wireless/RF	cypress.com/go/wireless

PSoC[®] Solutions

[psoc.cypress.com/solutions](#)
[PSoC 1](#) | [PSoC 3](#) | [PSoC 4](#) | [PSoC 5LP](#)

Cypress Developer Community

[Community](#) | [Forums](#) | [Blogs](#) | [Video](#) | [Training](#)

Technical Support

[cypress.com/go/support](#)

© Cypress Semiconductor Corporation, 2004-2014. The information contained herein is subject to change without notice. Cypress Semiconductor Corporation assumes no responsibility for the use of any circuitry other than circuitry embodied in a Cypress product. Nor does it convey or imply any license under patent or other rights. Cypress products are not warranted nor intended to be used for medical, life support, life saving, critical control or safety applications, unless pursuant to an express written agreement with Cypress. Furthermore, Cypress does not authorize its products for use as critical components in life-support systems where a malfunction or failure may reasonably be expected to result in significant injury to the user. The inclusion of Cypress products in life-support systems application implies that the manufacturer assumes all risk of such use and in doing so indemnifies Cypress against all charges.

Any Source Code (software and/or firmware) is owned by Cypress Semiconductor Corporation (Cypress) and is protected by and subject to worldwide patent protection (United States and foreign), United States copyright laws and international treaty provisions. Cypress hereby grants to licensee a personal, non-exclusive, non-transferable license to copy, use, modify, create derivative works of, and compile the Cypress Source Code and derivative works for the sole purpose of creating custom software and or firmware in support of licensee product to be used only in conjunction with a Cypress integrated circuit as specified in the applicable agreement. Any reproduction, modification, translation, compilation, or representation of this Source Code except as specified above is prohibited without the express written permission of Cypress.

Disclaimer: CYPRESS MAKES NO WARRANTY OF ANY KIND, EXPRESS OR IMPLIED, WITH REGARD TO THIS MATERIAL, INCLUDING, BUT NOT LIMITED TO, THE IMPLIED WARRANTIES OF MERCHANTABILITY AND FITNESS FOR A PARTICULAR PURPOSE. Cypress reserves the right to make changes without further notice to the materials described herein. Cypress does not assume any liability arising out of the application or use of any product or circuit described herein. Cypress does not authorize its products for use as critical components in life-support systems where a malfunction or failure may reasonably be expected to result in significant injury to the user. The inclusion of Cypress' product in a life-support systems application implies that the manufacturer assumes all risk of such use and in doing so indemnifies Cypress against all charges.

Use may be limited by and subject to the applicable Cypress software license agreement.