

SYMBOL DEFINITION	
A DIMENSION WITHOUT AN INSPECTION REPORT SYMBOL  DOES NOT REQUIRE INSPECTION. IT MAY BE CONTROLLED ON THE INDIVIDUAL COMPONENT DRAWING.	TOTAL NO OF INSPECTIONS REQUIRED
	7
	LAST NO. USED
	6

MISSING SYMBOLS	DWG STATUS					ZONE	REVISION HISTORY	AUTH	DR	APVD1	APVD2
	DATE	STG	REV	N/P	CHG						
NO MISSING SYMBOL NUMBER	04JN03	R	C1	-	-		CLEARED REV COL, MAT'L SPEC WAS R0071790 & ADDED NOTES (2 PLCS)	241267	RVP	RVP	RC

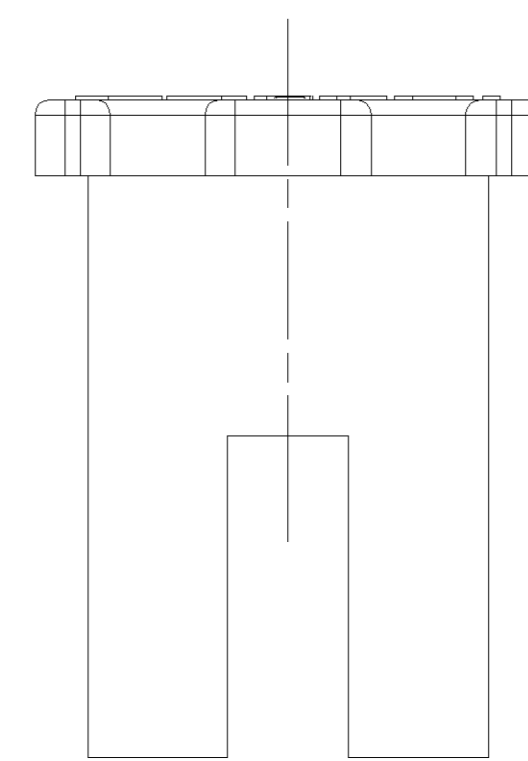
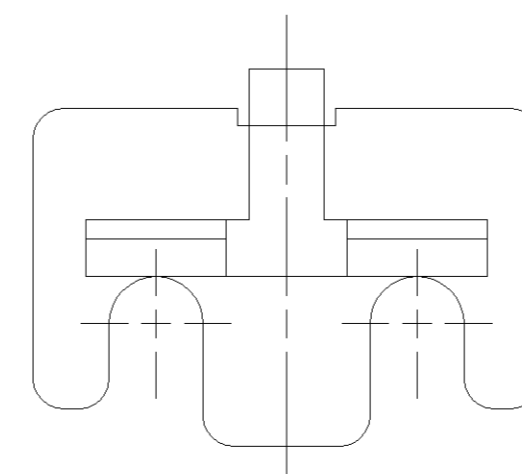
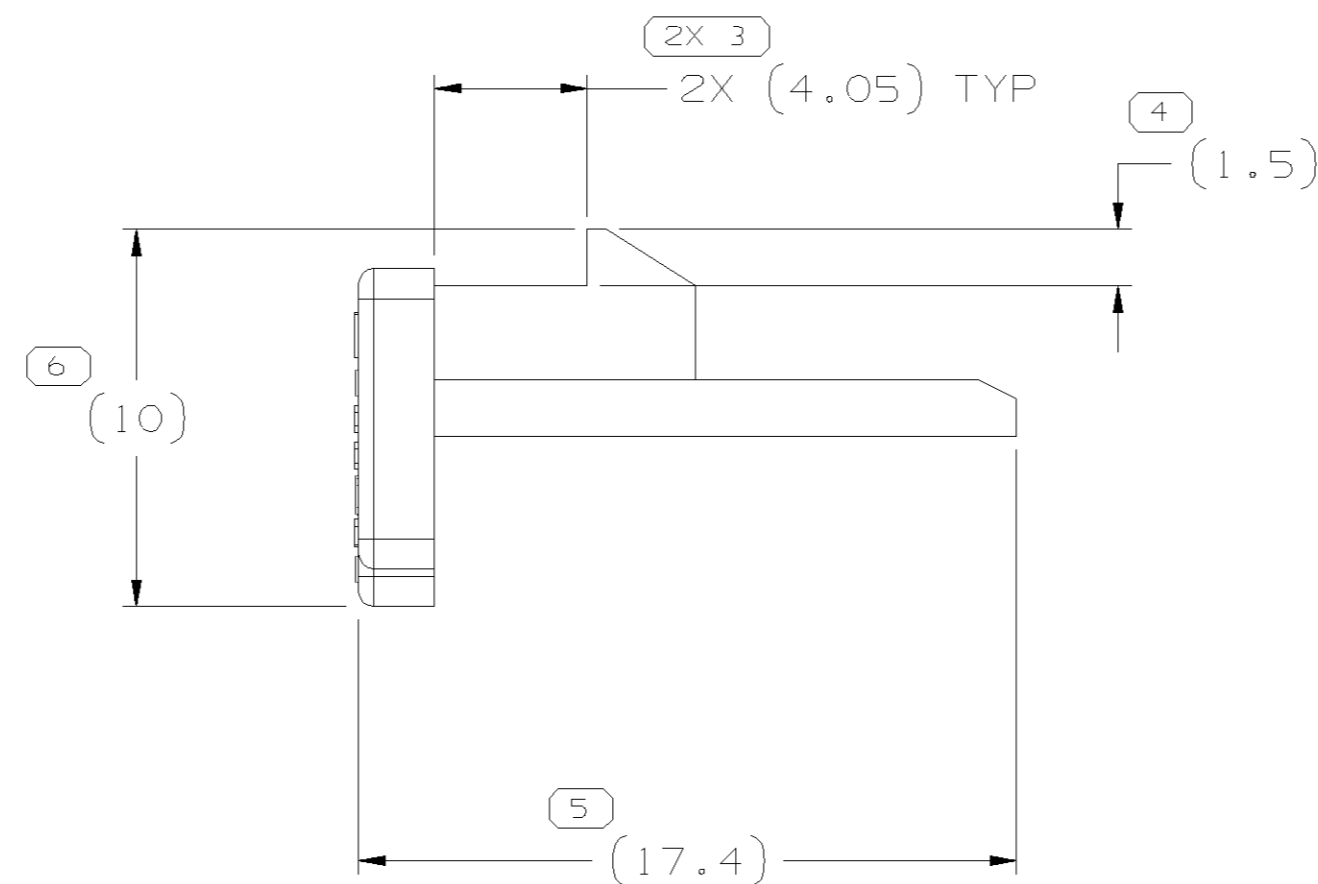
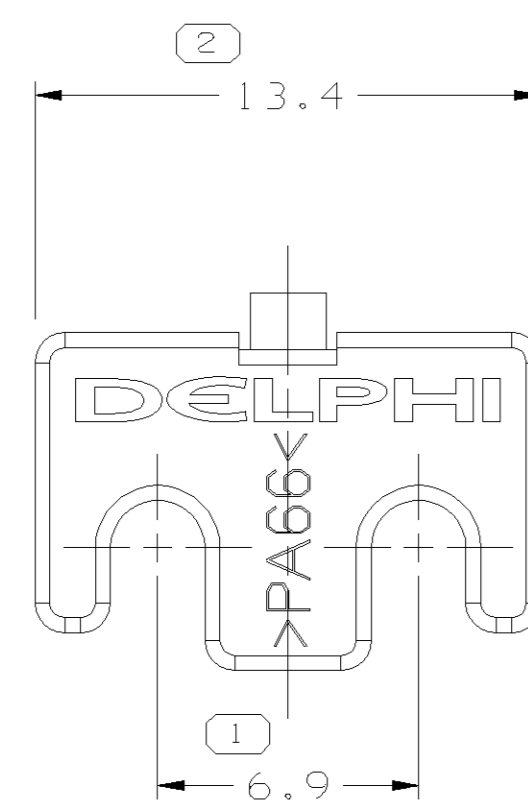
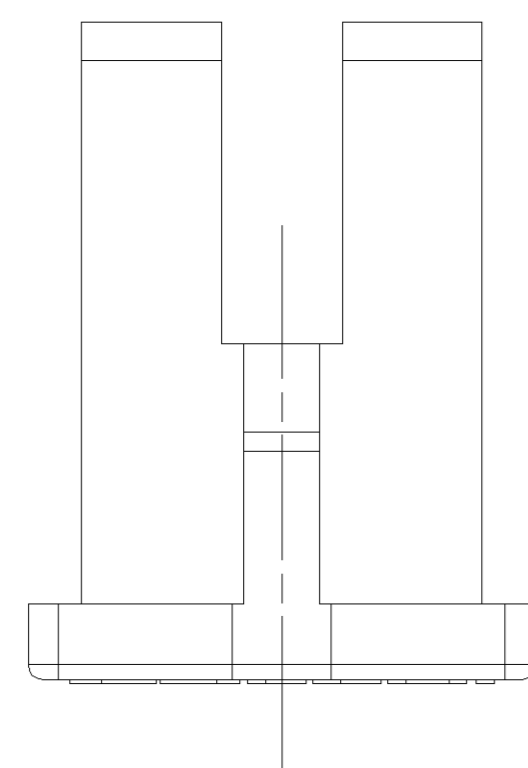

NOTES

- UNLESS OTHERWISE SPECIFIED AND/OR INDICATED: DIMENSIONS ARE TO FACE OF VIEW SHOWN AND AUTOMATICALLY ROUNDED BY COMPUTER FOR INSPECTION (SEE MATH MODEL FOR PRECISE DIMENSIONS). FOR ALL OTHER DIMENSIONS NOT SHOWN BUT REQUIRED FOR TOOL BUILD, SEE MATH MODEL FOR PRECISE TOOL PATH DATA.
- MATERIAL RECYCLING CODE >PA66< PER SAE J1344. (2.3)X(0.1) RAISED CHARACTERS AS SHOWN TO BE LOCATED ON ANY EXTERIOR SURFACE. OPTIONAL CONSTRUCTION TO BE NO MATERIAL RECYCLING CODE.
- MATING COMPONENTS OR EQUIVALENT: CONNECTOR 15304812
- (2.3)X(0.1) RAISED DELPHI CORPORATE BRAND TO BE LOCATED ON ANY EXTERIOR SURFACE, PREFERABLY VISIBLE AT FINAL ASSEMBLY. OPTIONAL CONSTRUCTION TO BE "PED" OR NO LOGO.
- THIS PART IS NOT CONTROLLED FOR AUTOMATIC FEEDING.

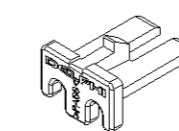

DWG TYPE		PART DRAWING	
STYLE			
VOLUME (CM ³)	DISTR CODE		
0.425	D		
ROUTING			
6900			
UNLESS OTHERWISE SPECIFIED			
THIS DOCUMENT IS IN ACCORDANCE WITH ASME Y14.5M-1994 AS AMENDED BY THE GM GLOBAL DIMENSIONING AND TOLERANCING ADDENDUM - 1997. ALL GEOMETRIC TOLERANCES AND RELATED DATUMS APPLY RFS. RULE #1 PERFECT FORM AT MMC DOES NOT APPLY WHEN RELATIONSHIP BETWEEN FEATURES IS ESTABLISHED BY ORIENTATION OR LOCATION TOLERANCES. SEPARATE POSITION CALLOUTS MAY BE GAGED SEPARATELY, REGARDLESS OF DATUM REFERENCE.			
ALL DIMENSIONS ARE IN MILLIMETERS			
REFERENCE			

DELPHI
 DELPHI PACKARD ELECTRIC SYSTEMS
 WARREN, OH

DR	DATE
APVD1 E. LOQUENO	04JN96
APVD2 M. VEGA	04JN96
APVD3 C. SCHAEFER	20JN96
APVD4	
APVD5	

SUBSTANCES OF CONCERN AND RECYCLED CONTENT PER DELPHI 10949001

MATERIAL
 M3592008 PA66 HS 1M BLU

DRAWING NAME
 TPA M/P 280

DRAWING NUMBER
 15304813

SIZE	SCALE	FRAME NO	SHEET NO	STG	REV	N/P
A1	5:1	1 OF 1	1 OF 1	R	C1	-

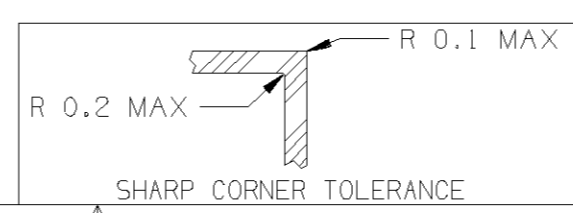

DIMENSIONAL RANGE (MM)		TOLERANCE UNLESS OTHERWISE SPECIFIED		ANGULAR TOLERANCE ±2°	
FROM	TO				
>0	>20	±0.15	±0.2	±0.3	±0.4
>20	>30			±0.5	±0.6
>30	>70			±0.6	±0.8
>70	>100			±1	±1.2
>100	>150				
>150	>200				
>200	>250				
>250	>300				
>300	>400				

THIRD ANGLE PROJECTION

DO NOT SCALE

USE MATH DATA