

SYMBOL	DEFINITION	TOTAL NO.	MISSING NUMBERS	REVISION HISTORY	DATE BY APPROVED
A	DIMENSION WITH OUT SYMBOLS DOES NOT HAVE TO BE REPEATED ON AN INDIVIDUAL COMPONENT DRAWING.	15	25-28.		
B					
C					
D					
E					
F					
G					
H					
I					
J					
K					
L					
M					
N					
O					
P					
Q					
R					
S					
T					
U					
V					
W					
X					
Y					
Z					

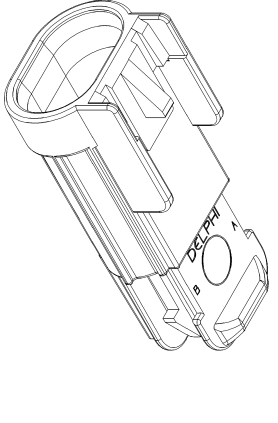
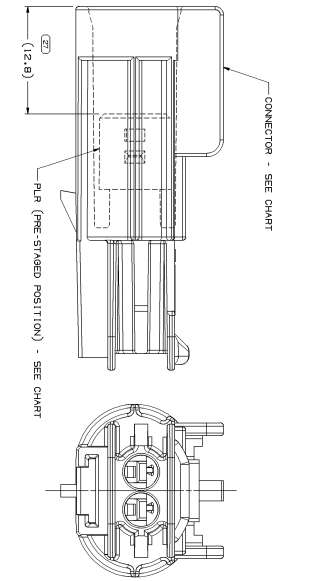
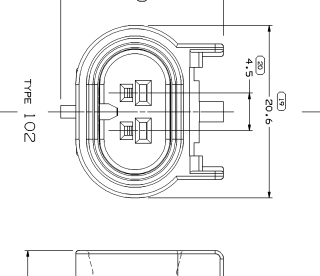
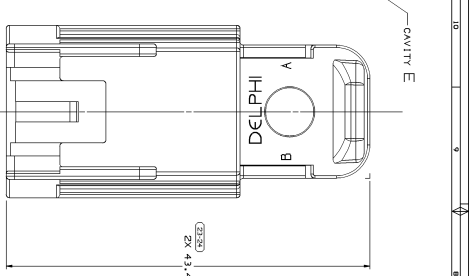
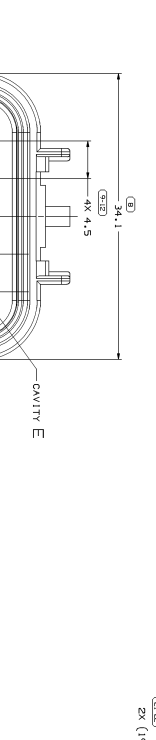
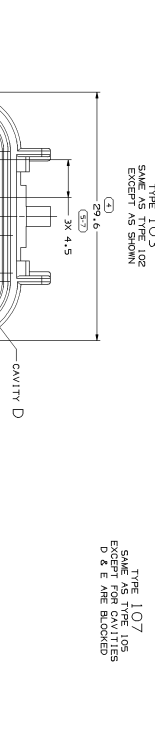
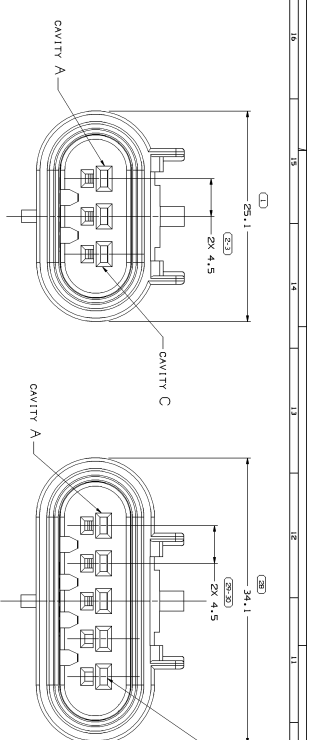

- NOTES
- UNLESS OTHERWISE SPECIFIED AND/OR INDICATED: DIMENSIONS ARE TO FACE OF VIEW SHOWN AND DIMENSIONS IN PARENT PARENTHESIS ARE FOR ALL BUILT UP MODELS FOR PRECISION DIMENSIONS - FOR ALL SEE MATH MODEL FROM PRECISE TOOL PATH DATA.
 - FOR APPLICATION DATA SEE THE INDIVIDUAL APPLICATION DRAWINGS.
 - THIS PRODUCT IS NOT CATEGORIZED AS AN APPEARANCE ITEM, MINOR DEFECTS ON E VESTIGES AND SCRATCHES THAT DO NOT AFFECT THE FIT, FORM, OR FUNCTION OF THE PART ARE PERMISSIBLE PER DRAW-4, -CS-01.

PART NO	REV/IMP	STATUS	TYPE	CONNECTOR	CONN COLOR	REPLACED BY	RESTRICTED USAGE
1306449	01		102	1306449	BLK		
1306450	01		104	1306449	BLK		
1306451	01		102	1306449	BLK		
1306452	01		102	1306449	BLK		
1306453	01		102	1306449	BLK		
1306454	01		102	1306449	BLK		
1306455	01		102	1306449	BLK		
1306456	01		102	1306449	BLK		
1306457	01		102	1306449	BLK		
1306458	01		102	1306449	BLK		
1306459	01		102	1306449	BLK		
1306460	01		102	1306449	BLK		
1306461	01		102	1306449	BLK		
1306462	01		102	1306449	BLK		
1306463	01		102	1306449	BLK		
1306464	01		102	1306449	BLK		
1306465	01		102	1306449	BLK		
1306466	01		102	1306449	BLK		
1306467	01		102	1306449	BLK		
1306468	01		102	1306449	BLK		
1306469	01		102	1306449	BLK		
1306470	01		102	1306449	BLK		
1306471	01		102	1306449	BLK		
1306472	01		102	1306449	BLK		
1306473	01		102	1306449	BLK		
1306474	01		102	1306449	BLK		
1306475	01		102	1306449	BLK		
1306476	01		102	1306449	BLK		
1306477	01		102	1306449	BLK		
1306478	01		102	1306449	BLK		
1306479	01		102	1306449	BLK		
1306480	01		102	1306449	BLK		
1306481	01		102	1306449	BLK		
1306482	01		102	1306449	BLK		
1306483	01		102	1306449	BLK		
1306484	01		102	1306449	BLK		
1306485	01		102	1306449	BLK		
1306486	01		102	1306449	BLK		
1306487	01		102	1306449	BLK		
1306488	01		102	1306449	BLK		
1306489	01		102	1306449	BLK		
1306490	01		102	1306449	BLK		
1306491	01		102	1306449	BLK		
1306492	01		102	1306449	BLK		
1306493	01		102	1306449	BLK		
1306494	01		102	1306449	BLK		
1306495	01		102	1306449	BLK		
1306496	01		102	1306449	BLK		
1306497	01		102	1306449	BLK		
1306498	01		102	1306449	BLK		
1306499	01		102	1306449	BLK		
1306500	01		102	1306449	BLK		

DELPHI
DELPHI POWER ELECTRONICS/ALTERNATOR DIVISION

DATE: 08/26/01
DRAWING NO: 15326962
REV: 1

TAXI ASM CONN M 87 150 SLD

SCALE: 1:1

UNIT: INCHES

THIRD ANGLE PROJECTION

DATE: 08/26/01
BY: J. L. MOORE
CHECKED: J. L. MOORE
DESIGNED: J. L. MOORE

DELPHI