

SYMBOL DEFINITION		TOTAL NO OF INSPECTIONS REQUIRED	MISSING SYMBOLS
A DIMENSION WITHOUT AN INSPECTION REPORT SYMBOL DOES NOT REQUIRE INSPECTION. IT MAY BE CONTROLLED ON THE INDIVIDUAL COMPONENT DRAWING.		23	NO MISSING SYMBOL NUMBER
	LAST NO. USED	8	

DWG STATUS					REVISION HISTORY		AUTH	DR	APVD/APVD	
DATE	STG	REV	IN/P	CHG	ZONE			1	2	
17AU01	R	01	-	-		WAS PE082095 & RELEASED	212995	EES	JMR	MJC
22AU01	R	02	-	-		6.04 WAS 5.95, 30 09 WAS 29.97, 11.4 WAS 10.94	213573	CJP	CJP	MJC
11SE01	R	03	-	-		ADDED APPROCH ANGLE TO LOCK ARMS	214289	BRB	BRB	MJC
11DE01	R	03	AA	-		ADDED 5X 5.6, PSD WAS 6	218604	CJP	CJP	MC
09DE03	R	03	AB	-		2X 6.04 +0.15/-0.3 WAS 2X 6.04; 30.09 +0.2/-0.5 WAS 30.09	249833	ADK	ADK	MC
12MR12	R	03	AC	-		UPDATE GRAPHICS	417318	JRV	FRE	JRV
21MY12	R	03	AD	-		REV 03AC WAS 04 PER AUTH NUMBER 417318 AND REVISED GRAPHICS	418211	AHG	JVM	JRV

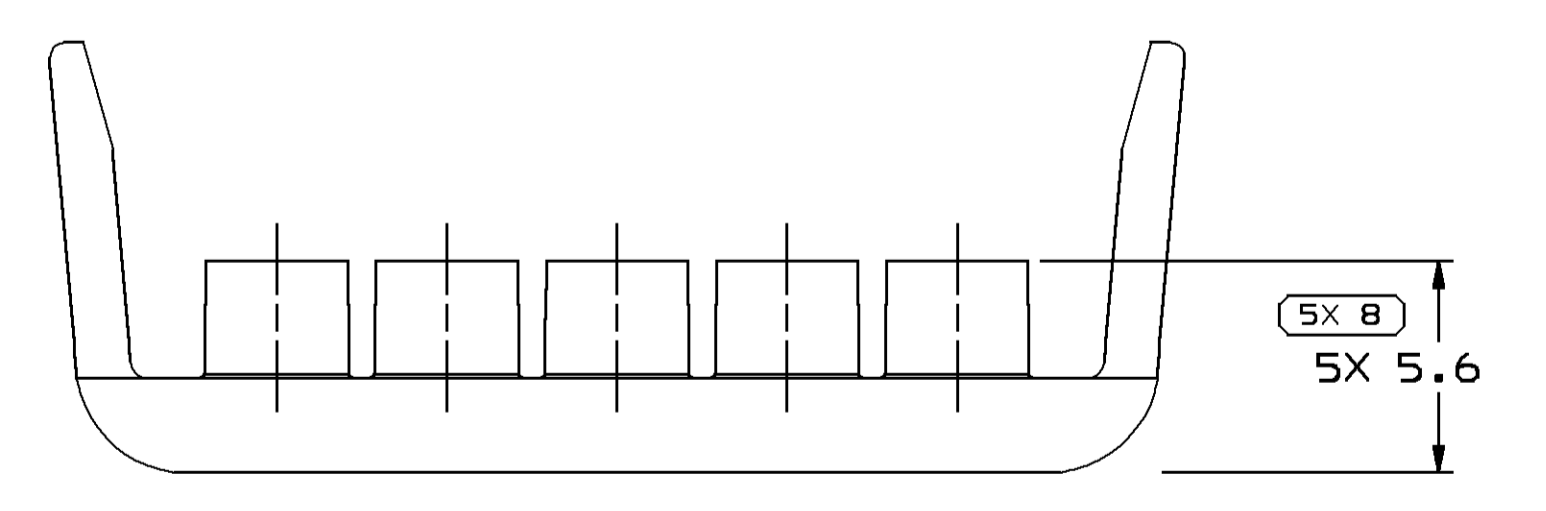
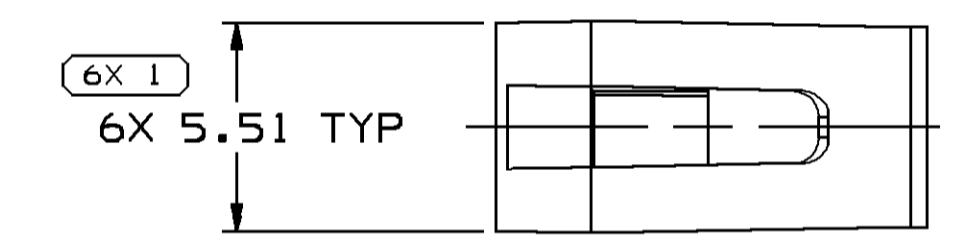
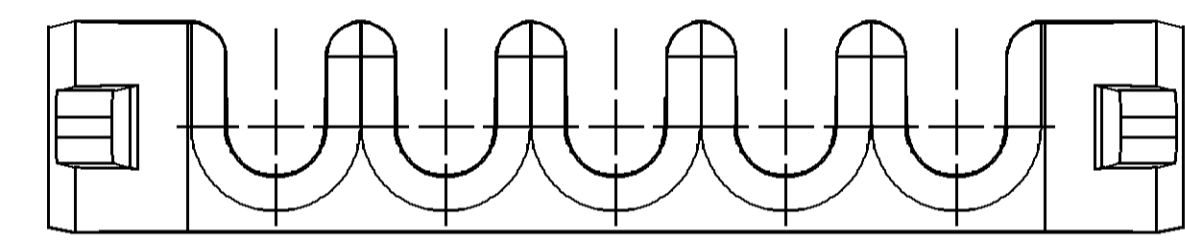
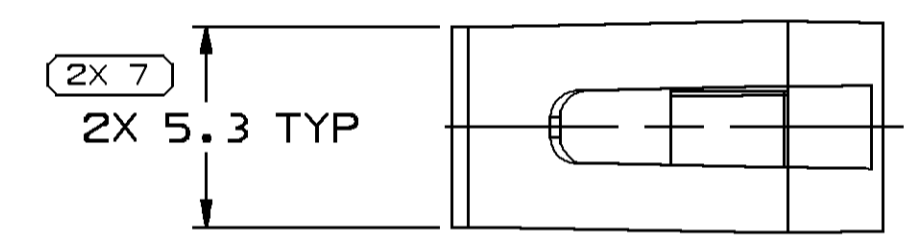
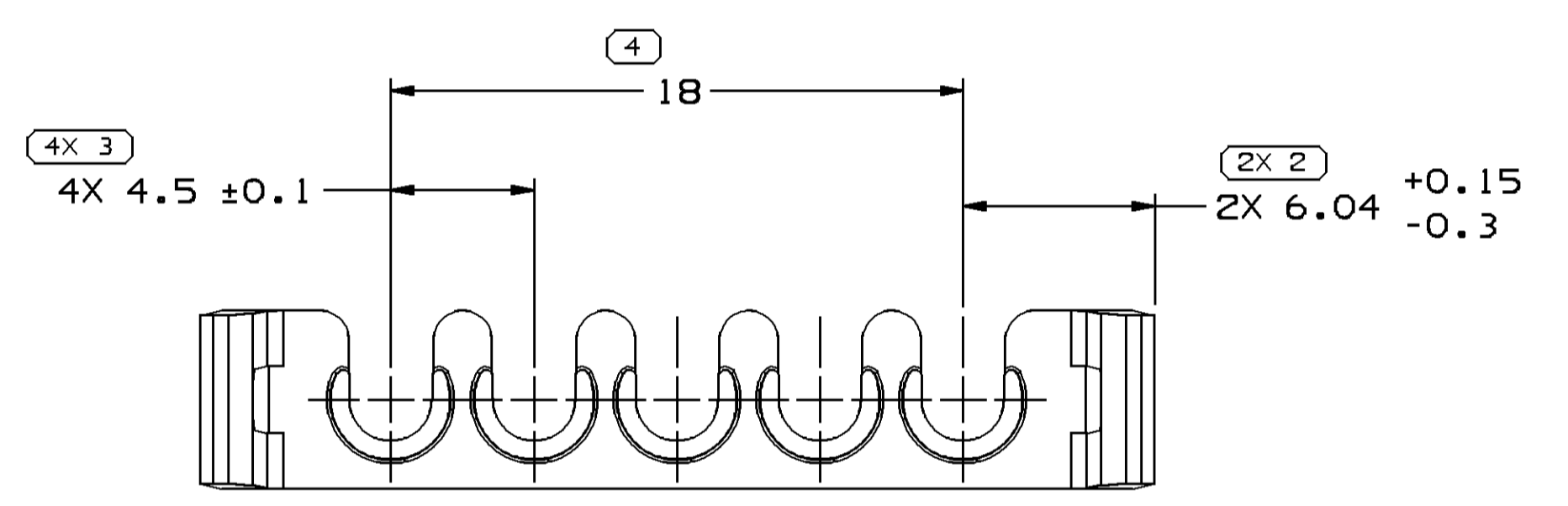
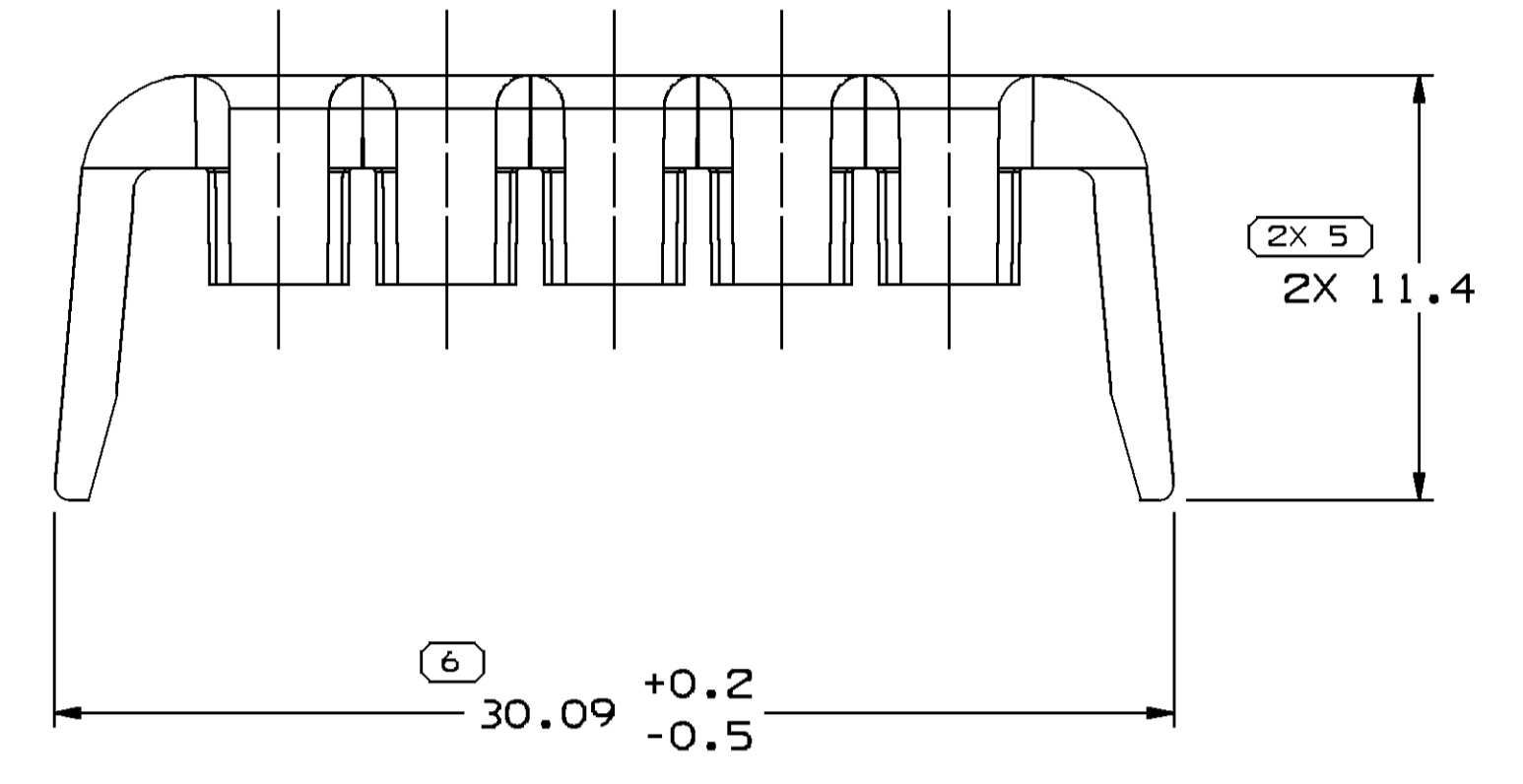
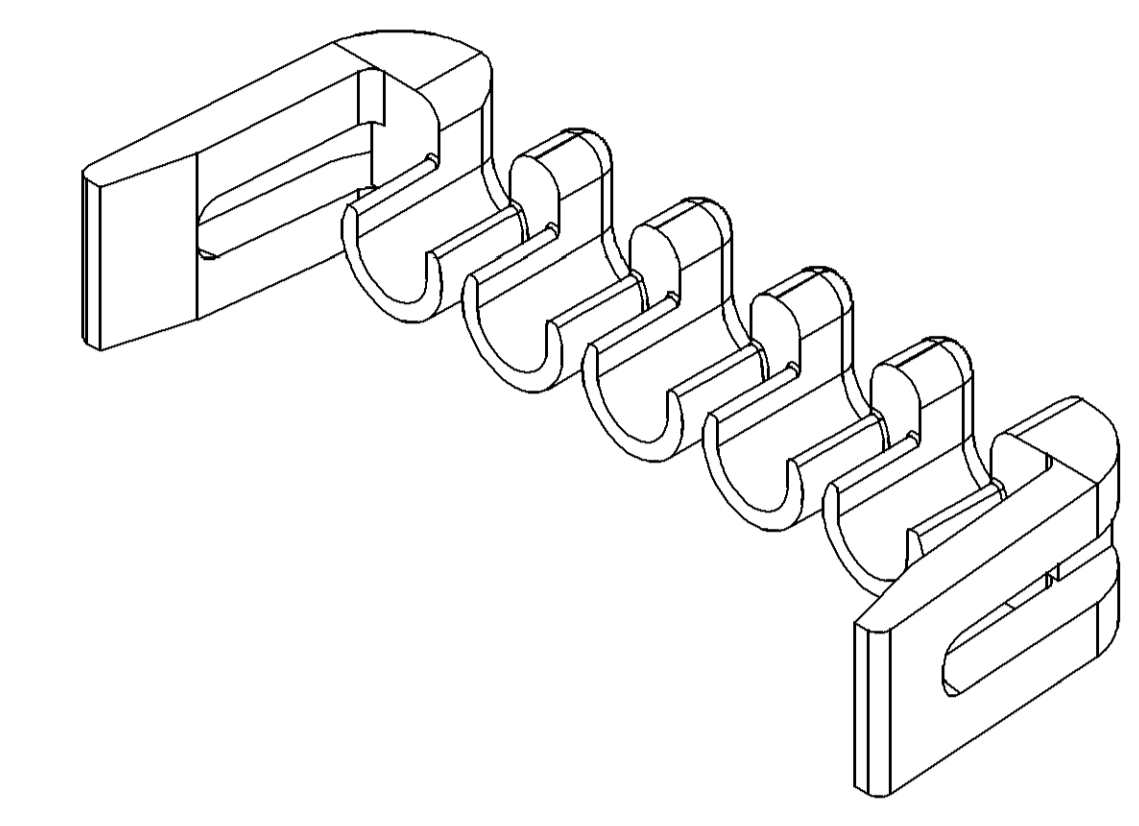

NOTES

- UNLESS OTHERWISE SPECIFIED AND/OR INDICATED: DIMENSIONS ARE TO FACE OF VIEW SHOWN AND AUTOMATICALLY ROUNDED BY COMPUTER FOR INSPECTION (SEE MATH MODEL FOR PRECISE DIMENSIONS). FOR ALL OTHER DIMENSIONS NOT SHOWN BUT REQUIRED FOR TOOL BUILD, SEE MATH MODEL FOR PRECISE TOOL PATH DATA. ALL RADII 0.4 DRAFT IS 1° ON ALL OUTSIDE SURFACES LIKE CAVITIES ARE IDENTICAL LOCKING FEATURES ARE IDENTICAL
- TOOL CAVITY IDENTIFICATION SHOULD BE LOCATED AS CLOSE TO THE GATE AS POSSIBLE.
- MATING COMPONENTS OR EQUIVALENT: CONNECTOR 1535203 & 1535204
- THIS PRODUCT IS NOT CATEGORIZED AS AN APPEARANCE ITEM, MINOR IMPERFECTIONS INCLUDING, BUT NOT LIMITED TO, FLOW MARKS, COLOR BLEMISHES, GATE VESTIGE, AND SOFT FLASH THAT DO NOT AFFECT THE FIT, FORM, OR FUNCTION OF THE PART ARE PERMISSIBLE PER DPNP-4.7-CS-01.

DIMENSIONAL RANGE (MM)		CHART E1	
FROM	TO	>	>
0	20	0.10	0.15
20	30	0.12	0.18
30	40	0.15	0.20
40	50	0.18	0.25
50	60	0.20	0.30
60	70	0.25	0.35
70	80	0.30	0.40
80	100	0.40	0.50
100	150	0.50	0.63
150	200	0.63	0.80
200	250	0.80	1.00
250	300	1.00	1.25
300	400	1.25	1.60
400		1.60	2.00

DELPHI
DELPHI PACKARD ELECTRICAL/ELECTRONIC ARCHITECTURE
WARREN, OH
COPYRIGHT 2001 DELPHI CORPORATION AND/OR ITS AFFILIATES. ALL RIGHTS RESERVED.
THIS DRAWING IS THE PROPERTY OF DELPHI CORPORATION. THE REPRODUCTION, DISTRIBUTION AND UTILIZATION OF THIS DOCUMENT OR ITS RELATED CAD WITH DATA AS WELL AS COMMUNICATION OF ANY CONTENT TO OTHERS, WITHOUT EXPRESS AUTHORIZATION IS PROHIBITED.

OR DATE

APV01 E. SEIDEL 17AU01
APV02 J. RICHARDSON 17AU01
APV03 M. CULP 20AU01
APV04

SUBSTANCE OF CONCERN AND RECYCLED CONTENT PER DELPHI 10949901

MATERIAL: POLYAMIDE COMPOUND PURPLE

DRAWING NAME: LOCK SECONDARY TPA 0T

DRAWING NUMBER: 15418547

SIZE: A0 SCALE: 5:1 FRAME NO: 1 OF 1 SHEET NO: 1 OF 1 STG: R IN/P: 03 AD

Date: 23-Nov-12 Time: 08:34