

Chargebuster Jr. H/O with Emitter Cassette Installation, Operation and Maintenance



Made in the United States of America



Figure 1. Desco Chargebuster Jr. H/O (High Output) Ionizer

Description

The Desco Chargebuster Jr. H/O ionizer is a compact and lightweight auto-balancing bench top ionizer with our patented* emitter cassette that slides out for easy cleaning and replacement. The Chargebuster Jr.'s unique active feedback balancing circuit automatically ensures and maintains the unit's ion balance despite variations in line voltage, air speed, or emitter electrode condition. The unit's compact, efficient design minimizes bench top space requirements and need for maintenance, while maximizing neutralization efficiency and overall performance.

Ionizers are useful in preventing electrostatic charge generation, ElectroStatic Discharge, ElectroStatic Attraction, as well as preventing equipment latch-up and safety related shock. ANSI/ESD S20.20 Paragraph 6.2.3.1 Protected Areas Requirement states: "Ionization or other charge mitigating techniques shall be used at the workstation to neutralize electrostatic fields on all process essential insulators if the electrostatic field is considered a threat." Ionization is used to neutralize charges on process necessary insulators and isolated semiconductors. Some examples of process necessary insulators are: the PC board itself, plastic test stands, plastic housing where a PCB may be mounted, as well as computer monitor screens and regular cleaning wipes. Examples of floating or isolated conductors are: loaded PCB mounted in a stand where the pins are not contacting the dissipative workstation. Ionization is not effective on items

that have large capacitance, like people and carts; however, ionizers should be considered as a method for charge neutralization in cases where grounding cannot be achieved.

Air ionization can neutralize the static charge on insulated and isolated objects by producing separate charges in the molecules of the gases of the surrounding air. When an electrostatic charge is present on objects in the work environment, it will be neutralized by attracting opposite polarity charges from the ionized air. Note that ionization systems should not be used as a primary means of charge control on conductors or people. (Reference: IEC 61340-5-2:1 paragraph 5.2.9).

The Chargebuster Jr. H/O is available in 2 models:

Item #	Voltage	Heater	NIST
60500	120 Volt	No	Yes
60501	120 Volt	Yes	Yes

All models come equipped with a universal IEC cord connector and a removable emitter cassette. Models [60500](#) and [60501](#) include a standard IEC cord set. All models are calibrated and traceable to NIST.

IONIZER SELECTION

ANSI/ESD S20.20 paragraph 6.1.1.2. ESD Control Program Plan Guidance states: "The Plan should include a listing of the specific type of ESD protective materials and equipment used in the Program." When selecting an ionizer life cycle costs should be considered including: equipment cost; installation cost; and operation and maintenance cost.

The unit is normally placed at one end of a workbench or area to be neutralized. It may also be wall mounted or mounted on a shelf. The ionizer's decay time (neutralization efficiency) will be best from approximately 6" to 42" in front of the unit, and will drop off as the distance from the unit increases.

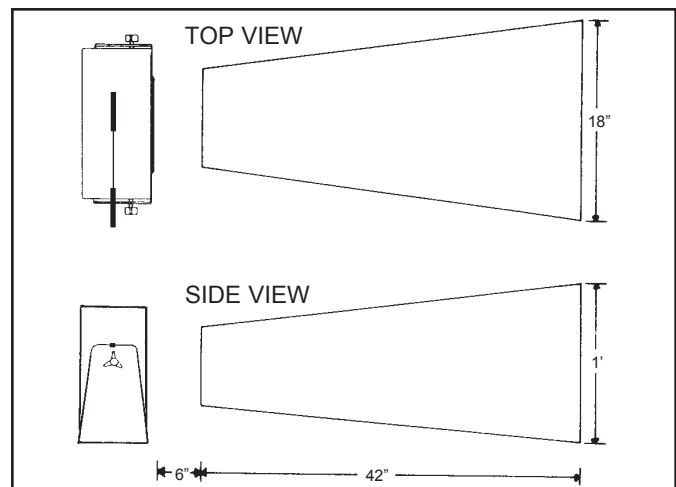

Figure 2. Area of optimum charge neutralization

* US Patent #6,137,670

Installation

Remove the ionizer from the carton and inspect for damage. Included with the unit should be:

- 1 Air Filter
- 1 Stand Assembly with Hardware
- 1 Power Cord

Mount the unit in the desired position. Set the front panel rocker switch to the "off" or mid position.

Install the power cord into an appropriate power source. Chargebuster Jr. models [60500](#) and [60501](#) operate on 120 VAC 50/60 Hz. The ionizer must be connected to a properly grounded receptacle for operation.

NOTE: We recommend not using on the same circuit as motors or equipment drawing heavy current as false alarms may occur.

Installing Stand Assembly

To install the stand assembly follow the instructions shown in Figure 3. You can mount the unit on a bench top or remove the rubber feet and bolt the stand to a wall or under a shelf as desired. Be sure to use appropriate fasteners. For best results, mount the unit so that no obstructions exist either on the intake or the outlet side.

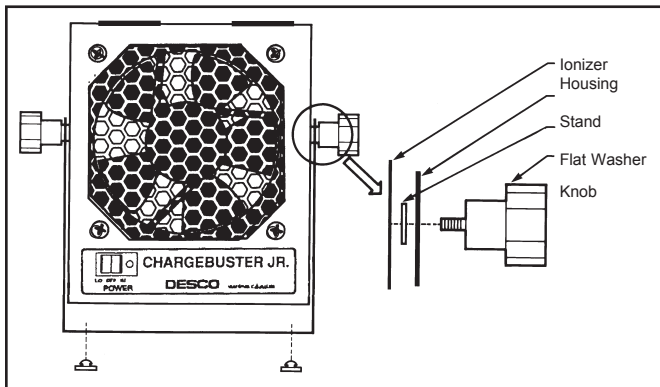

Figure 3. Installing stand assembly

Alternative Mounting

Use the [60466](#) Ionizer Mounting Arm as a mounting alternative for the Chargebuster Jr. Ionizer. The Ionizer Mounting Arm allows the Chargebuster Jr. Ionizer to be mounted off the bench top, saving valuable work bench space. The articulated movement of the arm assembly allows the user to precisely focus the ionizer's output directly onto the desired areas or across the entire work area.

The Ionizer Mounting Arm includes a C-clamp style mounting system for ease of installation. Figure 4 shows proper mounting of the arm on a workbench. The arm also includes an installed three prong power cord with an IEC termination.

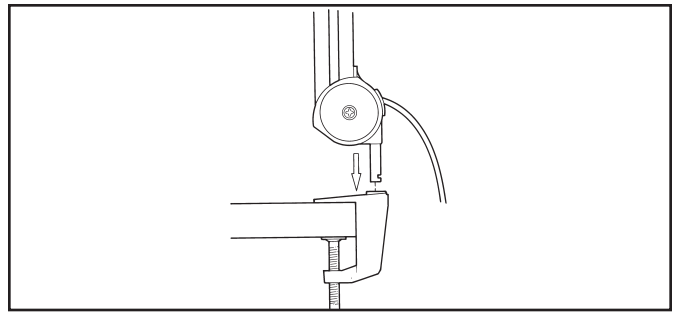

Figure 4. Installing mounting arm on workbench.

The arm's custom neck piece allows for easy mounting of a standard Jr. Ionizer via the stand assembly. The ionizer should be mounted to the arm by tightening the bolt onto the neck piece as shown in Figure 5.

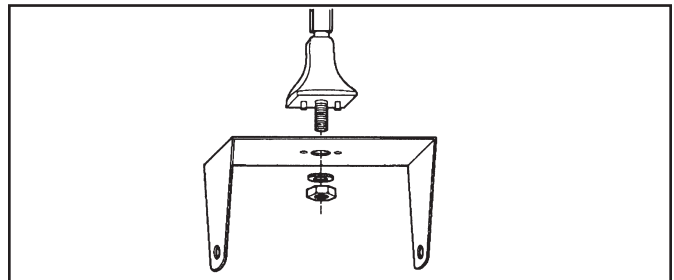

Figure 5. Installing Chargebuster Jr. to Ionizer Mounting Arm

The [60460](#) is sold separately. For detailed information on the installation and operation of the 60460 Ionizer Mounting Arm, ask for Technical Bulletin [TB-2056](#).

Operation

For item [60500](#) set the front panel rocker fan switch to either "HIGH" or "LOW" fan speed. Higher air flow will result in a faster neutralization rate. Safety interlock switches are provided internally on the emitter cassette. This insures that power is cut off in the event that the cassette is removed or not fully installed.

Aim the unit so that the maximum airflow is directed at the items or area to be neutralized.

The bottom rocker switch on the [60501](#) turns on a heater which will raise the temperature of the output air to about 10°F above ambient. The heater is only to offset the chill factor of the moving air. It is not intended to warm the workstation.

If the ionizer is used in a manner not specified by the manufacturer, the protection provided by the ionizer may be impaired.

Maintenance

“As with all ionizers, periodic maintenance will be needed to provide optimum performance.” (Reference: IEC 61340-5-2:1paragraph 5.2.9).

The frequency of monitoring ionizers really depends on how and where they are used. Since the majority of them use a fan to transport the ions to the working area, the cleanliness of the air directly affects their performance over time and how often the emitters should be cleaned.

EIA-625 recommends checking ionizers every 6 months, but this may not be suitable for many programs particularly since an out-of-balance may exist for months before it is checked again. ANSI/ESD S20.20 paragraph 6.1.3.1 Compliance Verification Plan Requirement states: “Test equipment shall be selected to make measurements of appropriate properties of the technical requirements that are incorporated into the ESD program plan.” And paragraph 6.1.3.2. Compliance Verification Plan Guidance states: “In addition to internal audits, external audits (Organization and supplier of ESDS items) should be performed to ensure compliance with planned requirements. Verifications should include routine checks of the Technical Requirements in the Plan. The frequency of verification checks should be based on the control item usage, its durability and associated risk of failure.”

Under normal conditions, the ionizer will attract dirt and dust (especially on the emitter electrodes). To maintain optimum performance, cleaning must be performed on a regular basis. The electrodes should be cleaned at least every six months. However, more frequent cleaning may be required if used in environments with more contaminants.

By their nature, all electric ionizers attract contaminants to the high voltage emitter pins. For best performance, this contamination must be kept to a minimum. This was a major factor in the design process of the Jr. ionizer with cassette. Although we could not eliminate the maintenance, we have made it far easier and much cleaner than ever before.

- Switch to the OFF position.
- Grasp the cassette ejector levers at the center and pivot outward about 90 degrees.
- Grasping the right and left corners, pull the cassette straight out of the ionizer.
- The cassette can then be replaced with a spare (item #60480, sold in pairs) or removed to another area for cleaning.
- Emitter pins are readily accessible and the cleaning of the cassette can be accomplished with a stiff brush or lint-free swab and isopropyl alcohol or other residue-free cleaning solvent.

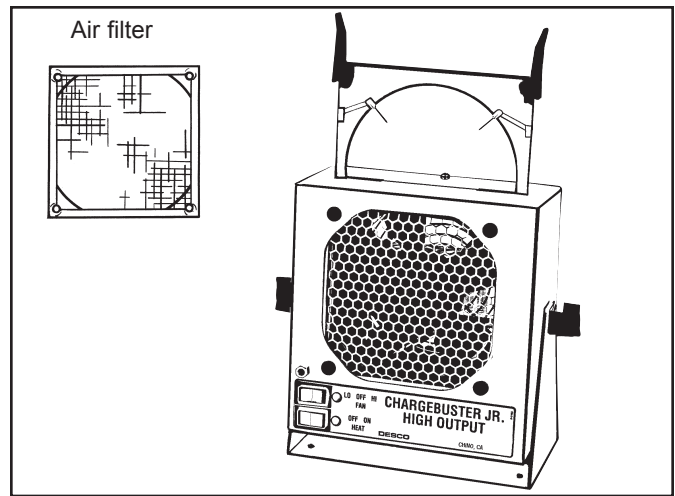

Figure 6. Removing the emitter cassette

Note: An air filter is included with the unit to be used in place of the unit’s grill in dusty or dirty environments. The air filter will reduce the frequency of cleaning necessary for the unit. Performance will be somewhat compromised due to air restriction. To install air filter, remove the four Phillips screws and install screen. The dimensions of the screen are 4-5/8" x 4-5/8" x .15". Construction is 30 x 30 aluminum mesh (30 wires/sq. in. in a crisscross pattern). This filter is easily removed and can be washed in warm, soapy water when it becomes dirty. Replacement filters are available as item #60455.

Neutralization Efficiency (Discharge Time)

The comparative efficiency of bench top ionizers is determined by ESD Association Standard S3.1 measuring offset voltage (balance) and both polarities’ discharge times. The ion emitter electrodes produce a high ion output for rapid charge dissipation. The decay rates measured using this standard for the ionizer are shown in Figure 9. The performance of the ionizer was measured with the unit positioned at varying locations with the fan speed on high and without a filter.

NOTE: Discharge times in seconds are representative only and are not a guarantee. Discharge times are actual measurements recorded in a factory ambient environment.

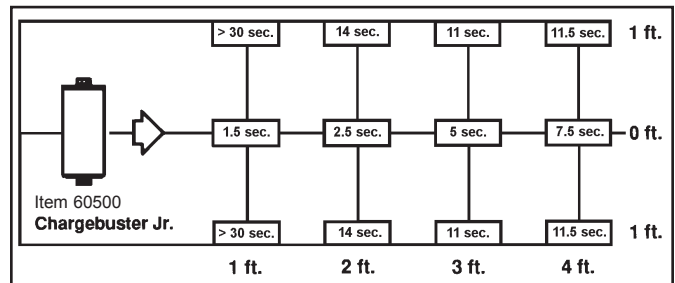

Figure 7. Discharge time in seconds from +1000 volts to +100 volts on a 6" x 6" charged plate monitor per ANSI/ESD-S3.1

Theory of Operation

By definition, materials that are insulators cannot have static charges removed via grounding as they do not conduct electricity. Ionizer emitters flood an area with millions of positive and negative charged electrons to neutralize insulators that have static charges on them.

The Chargebuster Jr. employs a safe non-nuclear Steady-State DC ionization source. Steady D.C. systems consist of separate negative and positive ion emitters connected by a pair of high-voltage cables to their respective high-voltage power supplies. The ionizer's unique, closed loop monitoring circuitry monitors ion output and automatically adjusts the unit to reach an equilibrium at perfectly balanced ion flow. The ionizer is designed to achieve balance under extreme conditions and is uniquely able to maintain balance in almost any environment. Desco ionizers meet the ANSI/ESD S20.20 minimum recommended technical requirement range of less than ± 50 volts voltage offset tested in accordance with ANSI EOS/ESD S3.1. Chargebuster Jr. Ionizers greatly exceed the requirement providing as low as ± 5 volt auto balancing.

The unit's circuitry also features a visual and audible 'CHECK IONIZER' alarm, which alerts the user to abnormal conditions caused by excessive electrode contamination or the failure of either the positive or negative power supply. When the Chargebuster Jr. is ON and operating normally, the blue LED indicator on the front of the unit will be steadily lit. 'CHECK IONIZER' is indicated when the blue LED is flashing. See the maintenance section for recommended maintenance procedures. This feature safeguards that the ionization is balanced, protecting sensitive components and assemblies from being exposed to harmful charging from an out of balance ionizer.

The Chargebuster Jr.'s quiet and gentle fan is designed so that it will not disturb personnel, paperwork, or delicate parts. The LED indicator mounted on the face of the unit allows the operator to easily verify whether it is ON, OFF, or in need of maintenance. The ionizer's emitter electrode material will not require replacement during the normal life of the product.

The Chargebuster Jr. is engineered for efficiency and durability. The unit's automatic feedback balancing circuitry eliminates the need for repeated calibration, making this ionizer highly dependable and cost effective.

Specifications

Input:	120 VAC - 50/60 Hz, 200 mA
Fuse Type:	
60500	Fast Blow 1 amp
60501	Slow blow 3 amps
Ozone:	Less than 0.05ppm
Airflow:	Dual speed, 77 CFM maximum
Weight:	4 lbs.
Cord:	IEC cord set
Dimensions:	
Without Stand:	6.7" x 6.6" x 3.5"
With Stand:	8.5" x 7.75"
Base:	6.8" x 3.4"
Holes:	0.122" in diameter, in a 5.83" x 2.4" rectangular pattern

Testing and Calibration

We recommend annual calibration of our ionizers. Ionizers are tested and calibrated using a charged plate analyzer. For proper testing, we recommend a charged plate analyzer and the procedure outlined in ESD Standard S3.1. This standard may be purchased from the ESD Association, 7902 Turin Rd., Suite 4, Rome NY 13440-2069, (315-339-6937). If you have access to a charged plate analyzer, you can use it to calibrate the Chargebuster Jr. We will be happy to send you information on the EMIT [50571](#) Charged Plate Analyzer.

Desco's 1 year limited warranty (see conditions below) may be voided if calibration is attempted within the first year of use of the product. Calibration traceable to National Institute of Standards and Technology (NIST) is a standard feature of all Models.

Calibration

For Audio On/Off and Alarm and Balance Adjustment see figure 8.

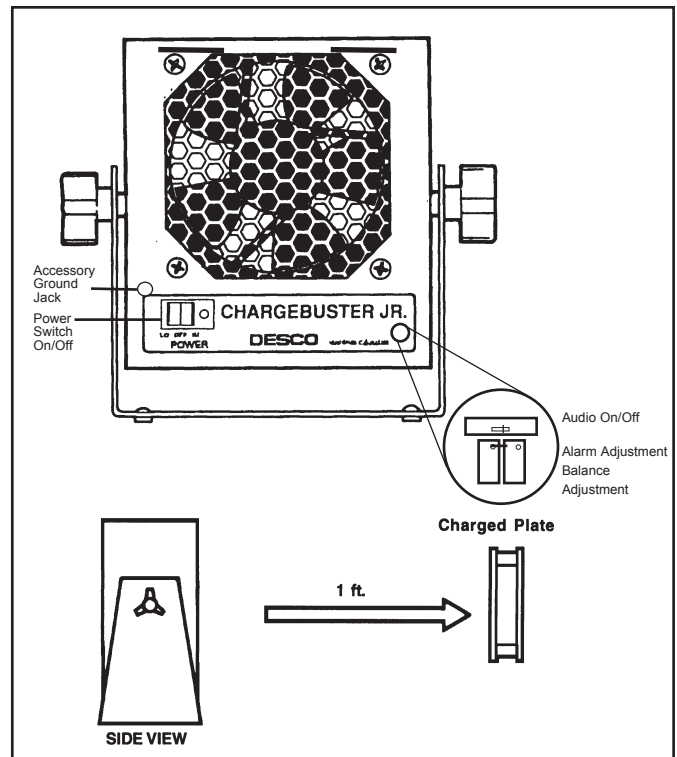

Figure 8. Calibration and position of charged plate for calibration.

Tools Required:

1. Charged plate analyzer
2. Potentiometer adjustment tool.
3. 9V Battery
4. Digital Multimeter

Note: We recommend that an electrician perform the following test:

Checking the Neutral-to-Ground voltage at the outlet

1. Be sure the multimeter is set on AC Volts (minimum 150-200 volts)

2. Measure between the ground pin and the neutral (should be the wider blade)
3. Voltage must not exceed 3 volts – Ref: National Electrical Code below
4. If voltage exceeds 3 volts, consult a licensed electrician to correct the problem

The National Electrical Code, in Sec. 210.19(A), FPN No.4, states: “Conductors for branch circuits as defined in Art. 100, sized to prevent a voltage drop exceeding 3% at the farthest outlet of power, heating, and lighting loads, or combination of such loads, and where the maximum total voltage drop on both feeders and branch circuits to the farthest outlet does not exceed 5%, provide reasonable efficiency of operation.” This amounts to a 6V drop in a 120V branch-circuit home run. Assuming equal losses in the supply and return conductors, then you should see an N-G voltage of 3V, which is a realistic condition.

Adjusting the balance:

1. Zero out the charged plate analyzer by pressing the zero button and then adjusting the potentiometer, or knob, on the charged plate itself. (The charged plate should be zeroed every 10 to 15 minutes if working on multiple units). The charged plate needs to be set to the float / decay position.
2. Place the Ionizer twelve inches from the charged plate and turn the unit on.
3. Adjust the balance potentiometer until the unit is 0 to $\pm 10V$ on the high fan speed. The unit should stay within 0 to $\pm 10V$ on the low fan speed.

Adjusting the alarm:

1. Turn the alarm potentiometer counter clockwise approximately 10 turns or until you hear or feel that it has reached the end. The unit should be alarming. If the unit is not alarming return to the factory.
2. Turn the alarm back clockwise until it stops alarming.
3. From the point where the unit stops alarming turn the potentiometer three more full revolutions clockwise.
4. Make sure that the charged plate is in the decay/float position and watch the voltage on the charged plate. Apply the 9 volt battery to the front grill and the case simultaneously. The voltage should rise and the unit should **START** alarming at approximately 100V to 200V. Flip the battery around and repeat for the opposite voltage. If the unit does not alarm at the proper voltage adjust the alarm potentiometer one half turn clockwise to increase the alarm voltage and counter clockwise to decrease alarm voltage.

Note: most multimeters have a Diode Check setting that will produce a low voltage on the test leads. The meter with this setting can be used in place of the 9V battery for testing the alarm.

Final Testing:

1. Check that the balance is still at 0 to $\pm 10V$ on the high fan speed. If it is not adjust the balance back to within tolerance.
2. Perform decay test on both the positive and negative voltages. To do this press the charge button on the charged plate and allow the plate to charge up over 1000v. Then

press the decay button on the charged plate and look at the timer to see how long it takes to decay the charge. The unit should decay the charge in less than 1.5 seconds. Toggle the \pm switch and repeat.

3. To test the alarm, apply the 9 volt battery to the front grill and the case simultaneously. Make sure that the charged plate is in the decay/float position and watch the voltage on the charged plate. The voltage should rise and the unit should **START** alarming at approximately 100V to 200V. Flip the battery around and repeat for the opposite voltage. If the unit does not alarm at the proper voltage adjust the alarm potentiometer one half turn clockwise to increase the alarm voltage and counter clockwise to decrease alarm voltage.

Repeat the testing procedure until the unit decays a 1000V charge to 100V in less than 1.5 seconds, and alarms at approximately 100V to 200V.

Health

There are no known health risks associated with our devices. The emitters work at about 4-6 kV and can create ozone, but there have been no significant measurement of ozone from our emitter sets, as all our existing units test well below the OSHA limit of 0.05 ppm ozone. For additional safety information, see “Dispelling an Old Myth” written by William Metz of Hewlett-Packard published in Evaluation Engineering magazine, September 2001.

Accessories

60509 IONIZER MOTION SENSOR

Desco offers the [60509](#) Desco Ionizer Motion Sensor as an accessory for the Chargebuster Jr. Ionizer. Use it to activate the ionizer when an operator is present and deactivate it when the workstation is vacant. The Ionizer Motion Sensor conserves energy and reduces ionizer maintenance.



Figure 9. Desco [60509](#) Ionizer Motion Sensor

Limited Warranty, Warranty Exclusions, Limit of Liability and RMA Request Instructions

See [Desco Terms and Conditions](#)