



**Important notes about Classic Panel Mount Indicator Catalog Pages**

**SCROLL DOWN TO VIEW CATALOG PAGE**

This catalog page is out-of-print and is used with the understanding that the information shown could be out-of-date. In many cases, part numbers shown on this page are discontinued. Most notably, many “Complete Assembly” parts, which consist of a cap and a base, can no longer be ordered by the 14-digit ordering code. To obtain these parts, please order the cap and base part numbers separately. This process provides the components contained with the original “Complete Assembly” part number.

All Dialight Classic Panel Mount Indicators need a leading 3-digit numerical series. In some cases, this catalog will show a 2-digit series. In this case, please add a leading zero. For example, 81-0211-300 becomes 081-0211-300.

Part numbers listed on Dialight catalog pages designate parts with Red lenses. For ordering lens colors other than red, consult the chart below. In most cases, the color is dictated by the 7<sup>th</sup> digit. For example, 095-0932-003 for a green cap.

Lens Colors	
1 - Red	5 - White
2 - Green	6 - Light Yellow
3 - Yellow	7 - Clear
4 - Blue	

[Click here for a cross reference guide to assembly part numbers.](#)

[Click here to view Frequently Asked Questions concerning Panel Mount Indicators.](#)

**SCROLL DOWN TO VIEW CATALOG PAGE**

# Large Incandescent Indicators

FOR MOUNTING IN 1" CLEARANCE HOLE  
FOR 24 TO 250V OPERATION

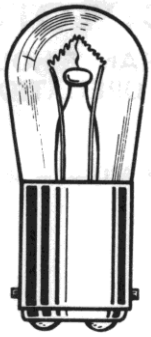

S-6  
DOUBLE CONTACT  
BAYONET BASE

See lamp ratings  
on page K.

Recognized under the component  
program of Underwriters'  
Laboratories Inc.  
75W., 125V.  

These series indicator lights meet or exceed requirements of MIL-L-3661.  
For materials and finishes of products in this group, see page 29D.

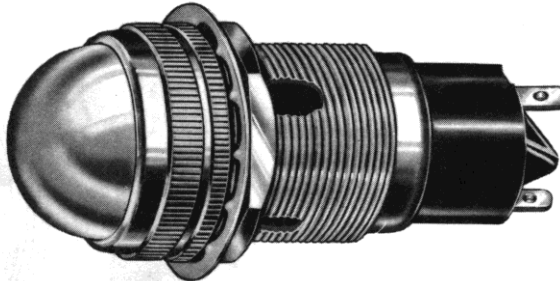

80-3402-1211-301  
Dome lens

## WITH SCREW-ON LENS CAPS

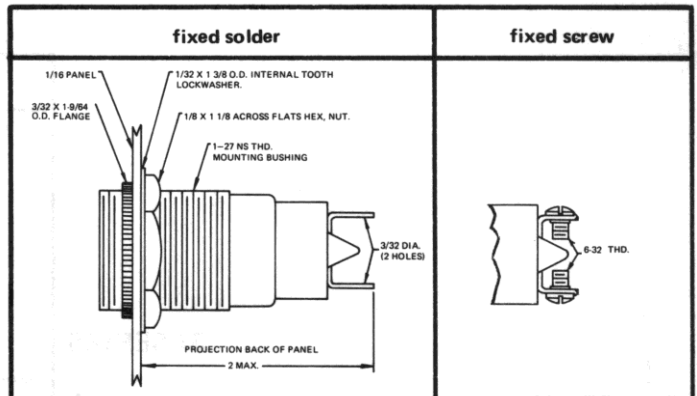

## 80 SERIES

### BASE PART NUMBERS

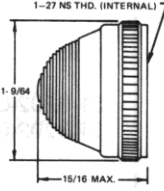
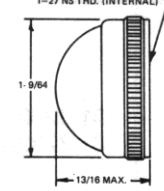
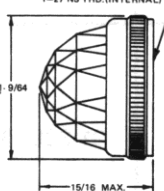
CAP PART NUMBERS		COMPLETE ASSEMBLY PART NUMBERS	
 <p><b>TORPEDO</b> 80-0511-300 back frosted 80-0531-300 unfrosted</p>		80-3402-05-301	80-3202-05-301
	 <p><b>DOME</b> 80-1211-300 back frosted 80-1231-300 unfrosted</p>		80-3402-1211-301 80-3402-1231-301
 <p><b>TORPEDO FACETED</b> 80-1331-300 unfrosted</p>		80-3402-1331-301	80-3202-1331-301

Part numbers shown in gray are normally  
in inventory at your Dialight Distributor.

Part numbers listed in this catalog designate products with RED lens.  
For ordering lens colors other than red, consult chart on page 2D.